



GLOBAL + OFFICES TO GO

expres

Global Product Navigation

GLOBAL SEATING

Arno	4003
.....	4004
Aspen	2851-3
.....	2852-3
Bakhita	6750
.....	6751
.....	6754
.....	6783
Citi	7875
.....	7876
.....	7877
.....	7885
Concorde	2424-18
Stool Kit	2241
.....	2243
Duet	6620
.....	6621
.....	6624
Factor	5540
.....	5541
File Buddy	1105
G1 Ergo Select	7331
.....	7332
Global Accord	2670-4
.....	2671-4

Goal	2236-6
.....	2237-3
.....	2237-5
.....	2237-6
.....	2239-6
Graham	3144
Granada	3212
.....	3217
Graphic	2738MB
Loover	2661-8
.....	2662-8
Luray	6461
.....	6462
Popcorn	6710
.....	6711
.....	6715
.....	6716
Roma	1906
.....	1899
Sidero	6900
.....	6901
Solar	8456
.....	8457
Sonic	6508
.....	6513

Spyker	6790
.....	6791
.....	6756
Spritz	6765C
Synopsis	5080-3
.....	5081-3
.....	5090-4
.....	5091-4
Truform	5450-3
.....	5451-3
.....	5450-8
.....	5451-8
.....	TS5450-3
.....	TS5451-3
.....	S5458-6
Tye	1950-4
.....	1951-4
Vion Fog	6321-0-OFAPG
.....	6322-0-OFAPG
.....	6325FO
Vion	6321-4(C)
.....	6321-8
.....	6322-8

[SEATING AT A GLANCE](#)



GLOBAL WORKSPACE + MEETING AREAS

- [Bakhita Tables](#)
- [Boardroom Tables](#)
- [Foli Height Adjustable Tables](#)
- [Genoa Desking](#)
- [Intelli Beam](#)
- [Lite Lift II Tables](#)
- [Swap Tables](#)
- [Zira Desking](#)

GLOBAL FILING + STORAGE

- [1900 Series Pedestals](#)
- [1900 Plus Lateral Files](#)
- [2500 Vertical Files](#)
- [9300 Plus Lateral Files](#)
- [File Buddy 1105](#)
- [Storage Cabinets](#)

OTG Product Navigation

WORK + TASK

OTG2801	OTG2803
OTG2821	OTG2913
OTG3101	OTG3103
OTG3191	OTG10904B
OTG11320B	OTG11325B
OTG11328B	OTG11343B
OTG11514B	OTG11516B
OTG11612B	OTG11631B
OTG11641B	OTG11642B
OTG11647B	OTG11650
OTG11651	OTG11652
OTG11653	OTG11685B
OTG11686B	OTG11692
OTG11710	OTG11715B
OTG11769B	OTG11850B
OTG11865B	OTG11920B
OTG11921B	OTG11922B
OTG11950B	OTG11980B
OTG12110B	OTG12112B
CONFERENCE + MANAGEMENT	
OTG2700	OTG2701
OTG2788	OTG10900B
OTG10901B	OTG10902B
OTG11300B	OTG11617B
OTG11618B	OTG11648B
OTG11657B	OTG11730B

OTG11732	OTG11734B
OTG11735	OTG11750B
OTG11776B	OTG11782B
OTG11786B	OTG11790B
OTG13026B	OTG11858B
OTG11975B	

STACK, NESTING + GUEST

GC3010	OTG1220B
OTG1221B	OTG2748
OTG2782	OTG2809
OTG3915B	OTG3918B
OTG11310B	OTG11311B
OTG11312	OTG11313
OTG11340B	OTG11341B
OTG11512B	OTG11697
OTG11698	OTG11700
OTG11701	OTG11703
OTG11704	OTG11705
OTG11706	OTG11740B
OTG11760B	OTG11761B
OTG11770BCX	OTG11770BES
OTG11892	OTG11820BCX
OTG11820BTH	OTG11923B
OTG11934	OTG13050B
OTG13050BT	

LOUNGE

OTG5001NA	OTG5002
OTG5002C	OTG5003
OTG5004	OTG5011
OTG13007	OTG13008
OTG13009	OTG13010
OTG13011	OTG13012

ACCESSORIES

OTG10700	OTG10701
OTG11600	OTG11620
OTG11924	

[SEATING AT A GLANCE](#)



OFFICES TO GO WORKSPACE SOLUTIONS

- [Collaboration Tables](#)
- [Conference + Meeting Tables](#)
- [Flip Top Training Tables](#)
- [Height Adjustable Tables](#)
- [Superior Laminate Workspace Solutions](#)

Think Global. Think Green.

The Environment — We believe now more than ever, that it is our responsibility to protect the environment and our precious natural resources for future generations. The growing importance of energy and environmental concerns continues to challenge us in this ever changing marketplace.

As an industry leader, Global continues to take proactive steps towards reducing the negative impacts on the environment. We are building “healthier” offices; investing in Research & Development and new technologies; reducing waste and the consumption of energy; and improving the quality of the air we breathe, all which can have a significant impact on our quality of life.

Global's recycled fabrics offer affordable, environmentally responsible alternatives to commercial textiles. We recycle 35,000 lbs. of fabric off cuts.

Epoxy powder coating process is solvent free. No harmful VOC's or lead. No toxins are released into the atmosphere.

Global has the products and resources to help your projects achieve LEED certification.

New technology allows us to reduce glue usage by 50%. In addition, our water based glue reduces emissions and requires less energy to apply.



Greenguard Certification

The GREENGUARD mark means that a product has been tested using stringent environmental chamber methods and found to meet GREENGUARD's Indoor Air Quality Standards. GREENGUARD Certified Products are low emitting and contribute minimal levels of pollutants to indoor environment.



Level Certification

level™ certification, based on the ANSI/BIFMA e3-2012 furniture sustainability standard, sets furniture manufacturers on a path toward greater sustainability over time. Based on environmental and social criteria set forth in the standard, a product's entire supply chain is assessed.



What's covered under the Global Lifetime Warranty?



Global's Lifetime Warranty covers manufacturer defects for seating, desks, tables, panels, metal storage and filing... everything you would need in a contract work environment covered for the life of the product.

NO WORRIES on plastic components, casters, glides, pneumatic cylinders, arm structures, arm caps and bases

NO WORRIES on drawer slides, trays, locks, keys, metal legs and grommets.

NO WORRIES on panel frames, edges and work surfaces.

For complete details, visit www.globalfurnituregroup.com.

What's covered under the Offices to Go® 5 Year Warranty?



Offices To Go® warrants its products to be free from defects in material and workmanship subject to the limitations below.

Under this warranty, claims must be made within the following periods from the original date of purchase: (a) non-moving parts are warranted for five years; (b) drawers, slides, leveling glides, locks, and other moving parts are warranted for two years; (c) gas cylinders, mechanisms, and other moving parts are warranted for two years; (d) upholstery materials and foam are warranted for two years.

Desking and Tables warranty is based on an eight hour, single shift workday. Seating warranty is based on an eight hour, single shift work day for users weighing up to 250 pounds. NOTE: Select light duty stacking chairs; OTG11696, and OTG11697, are warranted for users weighing up to 200 pounds.

Height adjustable bases (OTGHABASE2) electric motors, controllers and moving parts are warranted for 5 years. Height adjustable base warranty is based on an eight hour, single shift work day and maximum lifting capacity of 220lbs.

For complete details, visit www.OfficestoGo.com.

Symbols + Identification

2DAY LIGHTNING

SHIPS FROM THE FACTORY IN 2 DAYS!

When you see this symbol, the adjacent **GLOBAL** product is suitable for 2 Day shipment.



When you see these symbols, the adjacent **OFFICES TO GO** product is suitable for 2 Day shipment.



All seating product shown throughout this catalog is suitable for UPS shipment **unless otherwise noted**.



Why wait when you can have it all now?

Inside, you will find numerous workplace furniture solutions — seating, desks, files, tables and accessories — all at different price points — **and all available for quick delivery!**

Contents

GLOBAL

Seating Solutions

Work + Task Solutions	4-23
Conference + Management Solutions	24-33
Lounge + Reception Solutions	34-35
Stack, Nesting + Guest Solutions	36-45
Seating at a Glance	46-55
2 Day Lightning	56-61

Workspace + Meeting Areas Solutions

Zira	64-71
Genoa	72-79
Intelli Beam	80-81
Foli Height Adjustable Tables	80-81, 83
Swap Tables	82
Bakhita Tables	83
Boardroom Tables	84-85
Lite Lift II Table	85
Workstations at a Glance	86-87

Filing + Storage Solutions

1900 Plus Lateral	90
9300 Plus Lateral	90
2500 Vertical	91
1900 Series Pedestal	91
File Buddy	91
Storage Cabinets	91

OFFICES TO GO

Seating Solutions

Work + Task Solutions	94-117
Conference + Management Solutions	118-135
Drafting Solutions	136-137
Lounge + Reception Solutions	138-141
Stack, Nesting + Guest Solutions	142-155
Seating at a Glance	156-171
2 Day Ship	172-175

Workspace Solutions

Superior Laminate Workspace Solutions	176-193
Productivity Solutions	186-187
Power Solutions	186-187
Height Adjustable Tables	194-195
Flip Top Training Tables	196-197
Conference + Meeting Tables	198-199
Collaboration Table	200-201

REFERENCE

Green Story	Inside Front Cover
Global Warranty	Inside Front Cover
Offices to Go Warranty	Inside Front Cover
Symbols + Identification	Inside Front Cover
Quick Ship Textiles + Finishes	202-207

global furniture group



Citi 7876 (page 35) Two Seat Sofa and 7875 (page 35) Lounge Chair shown in Leather/Mock Leather, Black (550/450) and Tungsten (TUN) legs.

work + task



G1 Ergo Select 7332 (page 14) High Back Weight Sensing Synchro-Tilter shown in Waterfall, Dance (WA54).



Factor 5540-8 (page 6) Mesh High Back Weight Sensing Synchro-Tilter shown in Fusion, Granite (FU77) and Cloud (IC) frame.

All seating is nationally stocked and available immediately or part of the 2DAY LIGHTNING program and ships within two business days.



Factor 5540
 Mesh High Back Weight Sensing Synchro-Tilter with seat slider (-8), Height Adjustable arms (U2)
 List Price **\$625**
 Shown in Fusion, Granite (FU77) with Black Frame (BK) and Black Mesh (P-6)



Factor 5540
 Mesh High Back Weight Sensing Synchro-Tilter with seat slider (-8), Height Adjustable arms (U2)
 List Price **\$670**
 Shown in Fusion, Granite (FU77) with Shadow Frame (SH) and Black Mesh (P-6)



Factor 5540
 Mesh High Back Weight Sensing Synchro-Tilter with seat slider (-8), Height Adjustable arms (U2)
 List Price **\$670**
 Shown in Fusion, Granite (FU77) with Cloud Frame (IC) and Black Mesh (P-6)



Factor 5541
 Mesh Mid Back Weight Sensing Synchro-Tilter with seat slider (-8), Height Adjustable arms (U2)
 List Price **\$595**
 Shown in Fusion, Carbon (FU85) with Black Frame (BK) and Black Mesh (P-6)



Factor 5541
 Mesh Mid Back Weight Sensing Synchro-Tilter with seat slider (-8), Height Adjustable arms (U2)
 List Price **\$640**
 Shown in Fusion, Carbon (FU85) with Shadow Frame (SH) and Black Mesh (P-6)



Factor 5541
 Mesh Mid Back Weight Sensing Synchro-Tilter with seat slider (-8), Height Adjustable arms (U2)
 List Price **\$640**
 Shown in Fusion, Carbon (FU85) with Cloud Frame (IC) and Black Mesh (P-6)

Available immediately in the following textiles:



FU85 Carbon FU77 Granite P-6 Black



Factor™

Factor seating series recalculates the value equation for work chairs with an asymmetrical lumbar support, weight sensing synchro mechanism and adjustable arms.



Mid and high backrests are upholstered in a breathable mesh offering continuous support

Durable, lightweight frame

Height adjustable and split down the middle to flex independently side-to-side

Adjustable lumbar support provides personalized comfort and is standard on all models

Height adjustable arms (U2)

2DAY LIGHTNING
 SHIPS FROM THE FACTORY IN 2 DAYS!



Factor 5440-8 Mesh High Back Weight Sensing Synchro-Tilter, Height Adjustable Arms (U2). Shown in Fusion, Aqua (FU75). For available textiles, see pages 202-207.

Factor 2DAY LIGHTNING models are available in Black mesh + frame only.

MODEL	DESCRIPTION	LIST PRICE (starting at)
5540-8	High Back Weight Synchro-Tilter with U2 arms and Seat Slider Mechanism	\$625
5541-8	Mid Back Weight Synchro-Tilter with U2 arms and Seat Slider Mechanism	\$595

Vion™

Vion is no ordinary office chair. Designed by Zoey Chu, Vion's unique back provides exceptional comfort throughout the workday.

Mid and high backrests are upholstered in a breathable mesh offering continuous support

Durable, lightweight frame (Black finish)

Height adjustable and split down the middle to flex independently side-to-side

Adjustable lumbar support provides personalized comfort and is standard on all models



Vion 6321-8
Mesh High Back Weight Sensing Synchro-Tilter - Black frame
List Price **\$733**
Shown in Urban, Black Coal (UR22)



Vion 6322-8
Mesh Medium Back Weight Sensing Synchro-Tilter - Black frame
List Price **\$695**
Shown in Urban, Black Coal (UR22)



Vion 6321-4(C)
Mesh High Back Tilter with Fixed (C) Arms - Black frame
List Price **\$656**
Shown in Urban, Black Coal (UR22)

For specifications and dimensions see page 47.

Available immediately in the following textiles:



2DAY LIGHTNING

SHIPS FROM THE FACTORY IN 2 DAYS!



Vion 6321-8 Mesh High Back Weight Sensing Synchro-Tilter
Shown in Vion Mesh Blue (MS72) with Jenny Cascade (JN28) seat and optional Polished Aluminum base (FA).
For available textiles, see pages 202-207.

Vion 2DAY LIGHTNING models are available in five Vion Mesh colors:



Model pricing below includes Black frame

MODEL	DESCRIPTION	LIST PRICE (starting at)
6321-0	High Back Synchro-Tilter	\$733
6321-3	High Back Multi-Tilter	\$733
6321-4	High Back Tilter	\$656
6321-8	High Back Weight Sensing Synchro-Tilter	\$733
6322-0	Medium Back Synchro-Tilter	\$695
6322-3	Medium Back Multi-Tilter	\$695
6322-4	Medium Back Tilter	\$617
6322-8	Medium Back Weight Sensing Synchro-Tilter	\$695
TS6321-3	High Back Multi-Tilter (Heavy Duty)	\$951
TS6322-3	Medium Back Multi-Tilter (Heavy Duty)	\$913
6324*	Armless Low Back Side Chair	\$460
6324C*	Armless Low Back Side Chair with casters	\$513
6325*	Low Back Armchair	\$492
6325C*	Low Back Armchair with casters	\$545
6327-6	Armless Medium Back Task Stool	\$629
6328-6	Medium Back Task Stool	\$710
6331-0	Upholstered High Back Synchro-Tilter	\$831
6331-3	Upholstered High Back Multi-Tilter	\$831
6331-4	Upholstered High Back Tilter	\$743
6331-8	Uph. High Back Weight Sensing Synchro-Tilter	\$831
6332-0	Upholstered Medium Back Synchro-Tilter	\$793
6332-3	Upholstered Medium Back Multi-Tilter	\$793
6332-4	Upholstered Medium Back Tilter	\$710
6332-8	Uph. Medium Back Weight Sensing Synchro-Tilter	\$793
6335*	Upholstered Low Back Armchair	\$536

*Not UPSable

TS stands for "Three Shift" and each of the TS models are rated for 24-7 applications as well as weight rated up to 350 pounds.

Vion™ Fog

The Vion family is not only design savvy with its Fog frame finish, but is adaptable to any office or meeting room environment.

Vion Fog 6322-0FAFG
 Mesh Medium Back Synchro-Tilter with Back Angle Adjustment - Fog frame
 List Price **\$750**
 Shown in Fusion, Graphite (FU81)



Vion Fog 6321-0FAFG
 Mesh High Back Synchro-Tilter with Back Angle Adjustment - Fog frame
 List Price **\$788**
 Shown in Fusion, Graphite (FU81)



Vion Fog 6322-0FAFG
 Mesh Medium Back Synchro-Tilter with Back Angle Adjustment - Fog frame
 List Price **\$750**
 Shown in Fusion, Graphite (FU81)



Vion Fog 6325FO
 Mesh Side Chair - Fog frame and back
 List Price **\$547**
 Shown in Fusion, Graphite (FU81)

For specifications and dimensions see pages 47-48.

Available immediately in the following textiles:



2DAY LIGHTNING

SHIPS FROM THE FACTORY IN 2 DAYS!



Vion Fog 6321-8FAFG Mesh High Back Weight Sensing Synchro-Tilter
 Shown in Vion Mesh Natural (MS74) with Fusion, Tangerine (FU71) seat and Fog base.
 For available textiles, see pages 202-207.

Vion Fog 2DAY LIGHTNING models are available in five Vion Mesh colors:



Model pricing below includes Fog frame

MODEL	DESCRIPTION	LIST PRICE (starting at)
6321-0FAFG	High Back Synchro-Tilter	\$788
6321-3FAFG...	High Back Multi-Tilter	\$788
6321-4FAFG...	High Back Tilter	\$711
6321-8FAFG...	High Back Weight Sensing Synchro-Tilter	\$788
6322-0FAFG...	Medium Back Synchro-Tilter	\$750
6322-3FAFG...	Medium Back Multi-Tilter	\$750
6322-4FAFG...	Medium Back Tilter	\$672
6322-8FAFG...	Medium Back Weight Sensing Synchro-Tilter	\$750
TS6321-3FAFG	High Back Multi-Tilter (Heavy Duty)	\$1006
TS6322-3FAFG	Medium Back Multi-Tilter (Heavy Duty)	\$968
6324FO*	Armless Low Back Side Chair	\$515
6324CFO*	Armless Low Back Side Chair with casters	\$515
6325FO*	Low Back Armchair	\$547
6325CFO*	Low Back Armchair with casters	\$547
6327-6FAFG...	Armless Medium Back Task Stool	\$684
6328-6FAFG...	Medium Back Task Stool	\$765
6331-0FAFG	Upholstered High Back Synchro-Tilter	\$1007
6331-3FAFG...	Upholstered High Back Multi-Tilter	\$1007
6331-4FAFG...	Upholstered High Back Tilter	\$919
6331-8FAFG...	Uph. High Back Weight Sensing Synchro-Tilter	\$1007
6332-0FAFG...	Upholstered Medium Back Synchro-Tilter	\$969
6332-3FAFG...	Upholstered Medium Back Multi-Tilter	\$969
6332-4FAFG...	Upholstered Medium Back Tilter	\$886
6332-8FAFG...	Uph. Medium Back Weight Sensing Synchro-Tilter	\$969
6335FO*	Upholstered Low Back Armchair	\$536

*Not UPSable

TS stands for "Three Shift" and each of the TS models are rated for 24-7 applications as well as weight rated up to 350 pounds.

Aspen™

Aspen is a fully-featured task chair that delivers superior ergonomics, affordability and contemporary styling.



Aspen 2851-3*
High Back Multi-Tilter
List Price **\$1004**
Shown in Jenny, Charcoal (JN11)



Aspen 2852-3
Medium Back Multi-Tilter
List Price **\$975**
Shown in Jenny, Charcoal (JN11)

Available immediately
in the following textile:

Jenny



JN11 Charcoal



Synopsis®

A family of products with exceptional value and a transitional design defines Synopsis.



Synopsis 5080-3*
High Back Multi-Tilter
List Price **\$884**
Shown in Urban, Granite Rock (UR20)



Synopsis 5081-3*
Medium Back Multi-Tilter
List Price **\$800**
Shown in Urban, Granite Rock (UR20)



Synopsis 5081-3*
Medium Back Multi-Tilter
List Price **\$800**
Shown in Urban, Black Coal (UR22)

Available immediately
in the following textiles:

Urban



UR20 Granite Rock



UR22 Black Coal



2DAY LIGHTNING
SHIPS FROM THE FACTORY IN 2 DAYS!



Synopsis 5081-3* Medium Back Multi-Tilter
Shown in Silhouette, Verdant (SL24).
For available textiles, see pages 202-207.

MODEL	DESCRIPTION	LIST PRICE (starting at)
5080-0	High Back Synchro-Tilter	\$884
5081-0	Medium Back Synchro-Tilter	\$800
5080-3*	High Back Multi-Tilter	\$884
5081-3*	Medium Back Multi-Tilter	\$800
5090-4	High Back Tilter	\$552
5091-4	Medium Back Tilter	\$518

*Not UPSable

For additional Synopsis models see page 30.

For specifications and dimensions see page 49.

G1 Ergo Select™

G1 Ergo Select is expertly designed to fit the human body. Sit, move and work comfortably.



G1 Ergo Select 7332
High Back Weight Sensing Synchro-Tilter (-8), standard seat size and Height + Width Adjustable arms (G5)
List Price ***1005**
Shown in Waterfall, Dance (WA54)



G1 Ergo Select 7331
Medium Back Weight Sensing Synchro-Tilter (-8), standard seat size and Height + Width Adjustable arms (G5)
List Price ***953**
Shown in Waterfall, Dance (WA54)

Mechanism



Weight Sensing Synchro-Tilter



Armcaps Slide Forward and Backward



Standard Matching Thread Stitch



Armcaps Pivot Inwards and Outwards 25° and Slide Inwards and Outwards

Available immediately in the following textile:

Waterfall



WA54 Dance



For specifications and dimensions see page 30.

Granada®

Granada, the ideal, full-function, cost-effective computer chair.



Granada 3217
High Back Multi-Tilter
List Price ***847**
Shown in Waterfall, Grand (WA50)



Granada 3212
Low Back Multi-Tilter
List Price ***754**
Shown in Waterfall, Dance (WA54)

Mechanism



Multi-Tilter



Height Adjustable Arms



Seat Slider (MD)



Back Height

Available immediately in the following textiles:

Waterfall



WA50 Grand



WA54 Dance



For specifications and dimensions see page 49.

Truform®

Truform is available with a wide range of mechanisms including synchro-tilters, knee-tilters, multi-tilters, tilters, operators, task chairs, drafting stools (with task mechanisms) and multi-tilters for heavy duty applications (TS models).



Truform 5450-3
High Back Multi-Tilter
List Price **\$709**
Shown in Jenny, Ebony (JN02)



Truform 5451-8
Medium Back Weight Sensing Synchro-Tilter
List Price **\$680**
Shown in Jenny, Ebony (JN02)



Truform TS TS5450-3
High Back Multi-Tilter Heavy Duty
List Price **\$832**
Shown in Jenny, Ebony (JN02)



Truform TS5450-8 High Back Heavy Duty Weight Sensing Synchro-Tilter
Shown in Jenny, Ebony (JN02).
For available textiles, see pages 202-207.



Truform 5451-3
Medium Back Multi-Tilter
List Price **\$680**
Shown in Jenny, Ebony (JN02)



Truform 5450-8
High Back Weight Sensing Synchro-Tilter
List Price **\$709**
Shown in Jenny, Ebony (JN02)



Truform TS TS5451-3
Medium Back Multi-Tilter
Heavy Duty
List Price **\$803**
Shown in Jenny, Ebony (JN02)

Truform TS S5458-6
Medium Back Heavy
Duty Drafting Stool
List Price **\$987**
Shown in Jenny, Ebony (JN02)

Available immediately in the following textile:



JN02 Ebony



For specifications and dimensions see page 48.

2DAY LIGHTNING
SHIPS FROM THE FACTORY IN 2 DAYS!

MODEL	DESCRIPTION	LIST PRICE (starting at)
5450-0	High Back Synchro-Tilter	\$709
5450-3	High Back Multi-Tilter	\$709
5450-4	High Back Tilter	\$630
5450-8	High Back Weight Sensing Synchro-Tilter	\$709
5451-0	Medium Back Synchro-Tilter	\$680
709451-3	Medium Back Multi-Tilter	\$680
5451-4	Medium Back Tilter	\$601
5451-8	Medium Back Weight Sensing Synchro-Tilter	\$680
5457-6	Medium Back Drafting Stool (Armless)	\$807
5458-6	Medium Back Drafting Stool	\$943
S5457-6	Medium Back Drafting Stool (Heavy Duty) (Armless)	\$851
S5458-6	Medium Back Drafting Stool (Heavy Duty)	\$987
TS5450-3	High Back Multi-Tilter (Heavy Duty)	\$832
TS5451-3	Medium Back Multi-Tilter (Heavy Duty)	\$803

TS stands for "Three Shift" and each of the TS models are rated for 24-7 applications as well as weight rated up to 350 pounds.

2DAY LIGHTNING
SHIPS FROM THE FACTORY IN 2 DAYS!



Loover 2661-8 High Back Weight Sensing Synchro-Tilter
Shown in Match, Sand (MT21) with Vue Mesh, Sandy Beach (VU10).
For available textiles, see pages 202-207.

Loover 2DAY LIGHTNING models are available in five Vue Mesh colors:



MODEL	DESCRIPTION	LIST PRICE (starting at)
2661-0	High Back Synchro-Tilter	\$795
2661-3	High Back Multi-Tilter	\$795
2661-4	High Back Tilter	\$698
2661-8	High Back Weight Sensing Synchro-Tilter	\$795
2662-0	Medium Back Synchro-Tilter	\$760
2662-3	Medium Back Multi-Tilter	\$760
2662-4	Medium Back Tilter	\$675
2662-8	Medium Back Weight Sensing Synchro-Tilter	\$760

For specifications and dimensions see page 49.

Loover™

Loover features an open back frame upholstered with Vue mesh for individual comfort.



Loover 2662-8
Mesh Medium Back Weight Sensing Synchro-Tilter
List Price **\$760**
Shown in Urban, Black Coal (UR22) with Vue Mesh, Coal Black (VU19)



Loover 2661-8
Mesh High Back Weight Sensing Synchro-Tilter
List Price **\$795**
Shown in Urban, Granite Rock (UR20) with Vue Mesh, Coal Black (VU19)

Available immediately in the following textiles:



UR20 Granite Rock **UR22** Black Coal **VU19** Coal Black



Roma™

Roma fits the bill without taking up too much space.



Roma 1906
Mesh Medium Back Task
List Price **\$700**
Shown in Urban, Black Coal (UR22) with Black Mesh



Roma 1899
Mesh Back Nesting Armchair
List Price **\$567**
Shown in Urban, Black Coal (UR22) with Black Mesh

Available immediately in the following textile:

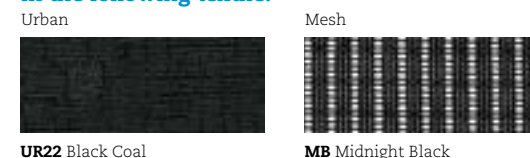

UR22 Black Coal **MB** Midnight Black



2DAY LIGHTNING
SHIPS FROM THE FACTORY IN 2 DAYS!



Roma 1906 Mesh Medium Back Task
Shown in Etch, Drift (ET81).
For available textiles, see pages 202-207.
Roma 2DAY LIGHTNING models are available in Black mesh only.

MODEL	DESCRIPTION	LIST PRICE (starting at)
1901	Medium Posture Back (Armless)	\$655
1906	Medium Back Task	\$700
1906RA	Medium Back Task (Height Adjustable Arms)	\$761
1890	Plastic Back Nesting Armchair	\$522
1899	Nesting Armchair	\$567

For specifications and dimensions see pages 49, 55.

2DAY LIGHTNING
SHIPS FROM THE FACTORY IN 2 DAYS!



Graphic 2738MB Mesh Medium Back Posture Back
Shown in Replay, Dove (RP33).
For available textiles, see pages 202-207.

Graphic models are available in Black mesh only.

Graphic™

The Graphic series offers casual style and contemporary scale in an affordable ergonomic design.



Graphic 2738MB
Mesh Medium Back Posture Back
List Price ***688**
Shown in Replay, Coal (RP34) with Black Mesh

Mechanism



Tilt-lock mechanism with tilt-tension control

Available immediately in the following textile:

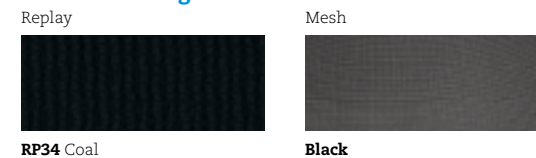

Tye™

The Tye series offers tremendous value in air-flow mesh technology, as well as style.



Tye 1950-4
Mesh High Back Tilter
List Price ***646**
Shown in Jenny, Ebony (JN02) and Mock Leather, Black (550)



Tye 1951-4
Mesh Medium Back Tilter
List Price ***618**
Shown in Jenny, Ebony (JN02) and Mock Leather, Black (550)

Available immediately in the following textiles:

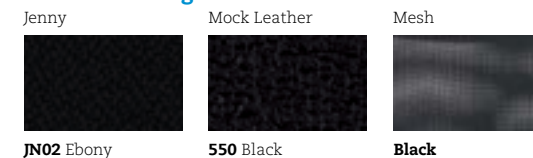

MODEL	DESCRIPTION	LIST PRICE (starting at)
2736MB	Mesh Medium Back Posture Back (Armless)	\$599
2737	Upholstered Medium Back Posture Back (Armless)	\$599
2738	Medium Back Posture Back	\$599
2738MB	Mesh Medium Back Posture Back	\$660
2739	Upholstered Medium Back Posture Back	\$660

2DAY LIGHTNING
SHIPS FROM THE FACTORY IN 2 DAYS!



Goal 2237-3 Low Back Multi-Tilter
Shown in Fusion, Cobalt (FU83).
For available textiles, see pages 202-207.

Goal™

Goal is ergonomically and economically engineered for maximum comfort with multiple features typically found on more expensive seating.



Goal 2237-3
Low Back Multi-Tilter
List Price **\$562**
Shown in Fusion, Granite (FU77)

Goal 2237-5
Low Back Operator
List Price **\$442**
Shown in Fusion, Granite (FU77)



Goal 2237-6
Low Back Task
List Price **\$368**
Shown in Fusion, Carbon (FU85)

Goal 2239-6
Low Back Task - Armless
List Price **\$284**
Shown in Fusion, Carbon (FU85)

Available immediately in the following textiles:

Fusion



FU83 Cobalt



FU85 Carbon



FU77 Granite



MODEL	DESCRIPTION	LIST PRICE (starting at)
2235-6	Low Back Task Drafting Stool	\$479
2236-6	Low Back Task Drafting Stool (Armless)	\$421
2237-3	Low Back Multi-Tilter	\$562
2237-5	Low Back Operator	\$442
2237-6	Low Back Task	\$368
2239-6	Low Back Task (Armless)	\$284

For Goal stool see page 31.

For specifications and dimensions see page 46.

Graham™

Graham features a multi-curved back with an impact resistant outer back shell.



Graham 3144
Low Back Ergo-Tilter
List Price **\$561**
Shown in Fusion, Carbon (FU85)

Features



Impact resistant outer back shell

Available immediately in the following textile:

Fusion



FU85 Carbon



2DAY LIGHTNING
SHIPS FROM THE FACTORY IN 2 DAYS!



Graham 3144 Low Back Ergo-Tilter
Shown in Terrace, Tigerlily (TC61).
For available textiles, see pages 202-207.

MODEL	DESCRIPTION	LIST PRICE (starting at)
3144	Low Back Ergo-Tilter	\$561

For specifications and dimensions see page 46.

confer ence + manage ment



All seating is nationally stocked and available immediately or part of the 2DAY LIGHTNING program and ships within two business days.

2DAY LIGHTNING
SHIPS FROM THE FACTORY IN 2 DAYS!



Global Accord 2670-2 High Back Knee-Tilter
Shown in Elevate, Halo (EL51).
For available textiles, see pages 202-207.

Global Accord™

Global Accord features a finely detailed Polished Aluminum arm with a sling style back, upholstered with rolled and pleated details.



Global Accord 2670-4
High Back Tilter
List Price ***1011**
Shown in Allante FRee, Ink (A16F)



Global Accord 2671-4
Medium Back Tilter
List Price ***979**
Shown in Allante FRee, Gibraltar (A12F)

Available immediately in the following textiles:

Allante FRee Vinyl



A16F Ink



A12F Gibraltar



Luray™

As the workplace continues to change, meetings and conferences can still be long days with demanding agendas. Luray provides ample proportions and full back support in an upholstered seating series to keep participants at their best.



Luray 6461
High Back Tilter
List Price (Terrace Fabric) ***918**
List Price (Allante FRee Vinyl) ***974**
Shown in Terrace, Ironwork (TC71)



Luray 6462
Medium Back Tilter
List Price (Terrace Fabric) ***890**
List Price (Allante FRee Vinyl) ***941**
Shown in Terrace, Ironwork (TC71)

Mechanism



Tilter



Plastic fixed arm with self-skinned urethane (ssu) armcap

Available immediately in the following textiles:

Terrace Fabric (Grade 1)



TC71 Ironwork

Allante FRee Vinyl (Grade 2)



A16F Ink



MODEL	DESCRIPTION	LIST PRICE (starting at)
2670-2	High Back Knee-Tilter	\$1166
2670LM-2	High Back Knee-Tilter (Leather/Mock Leather)	\$1406
2670-4	High Back Tilter	\$959
2670LM-4	High Back Tilter (Leather/Mock Leather)	\$1204
2671-2	Medium Back Knee-Tilter	\$1137
2671LM-2	Medium Back Knee-Tilter (Leather/Mock Leather)	\$1347
2671-4	Medium Back Tilter	\$929
2671LM-4	Medium Back Tilter (Leather/Mock Leather)	\$1173
2672-6	Medium Back Stool	\$1141
2672LM-6	Medium Back Stool (Leather/Mock Leather)	\$1334

Solar™

The one-piece frame and matching base are available in Alabaster and Asphalt along with two coordinating mesh colors.

Solar 8457
Medium Back Mesh Tilter
List Price **\$877**
Shown in Midnight (MDN) Mesh and Alabaster (ABR) frame.



Solar 8457
Medium Back Mesh Tilter
List Price **\$877**
Shown in Midnight (MDN) Mesh and Alabaster (ABR) frame



Solar 8456
Medium Back Mesh Tilter
List Price **\$800**
Shown in Storm (STM) Mesh and Asphalt (APT) frame



Available immediately in the following textile + finish:

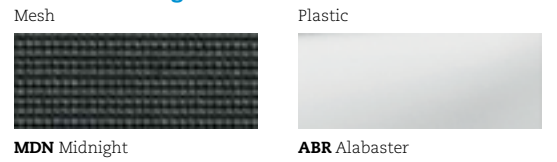

MDN Midnight **ABR** Alabaster

Available immediately in the following textile + finish:

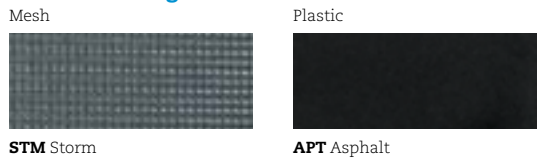

STM Storm **APT** Asphalt



For specifications and dimensions see page 51.

2DAY LIGHTNING
SHIPS FROM THE FACTORY IN 2 DAYS!



Synopsis 5090-4 High Back Tilter
Shown in Couture, Neptune (CE75).
For available textiles, see pages 202-207.

Synopsis®

A family of products with exceptional value and a transitional design defines Synopsis.



Synopsis 5090-4
High Back Tilter
List Price **\$552**
Shown in Urban, Granite Rock (UR20)



Synopsis 5091-4
Medium Back Tilter
List Price **\$518**
Shown in Urban, Granite Rock (UR20)



Synopsis 5091-4
Medium Back Tilter
List Price **\$518**
Shown in Urban, Black Coal (UR22)

Available immediately in the following textiles:



UR20 Granite Rock



UR22 Black Coal



MODEL	DESCRIPTION	LIST PRICE (starting at)
5080-0	High Back Synchro-Tilter	\$884
5080LM-0	High Back Synchro-Tilter (Leather)	\$1388
5081-0	Medium Back Synchro-Tilter	\$800
5081LM-0	Medium Back Synchro-Tilter (Leather)	\$1242
5080-3*	High Back Multi-Tilter	\$884
5080LM-3*	High Back Multi-Tilter (Leather)	\$1388
5081-3*	Medium Back Multi-Tilter	\$800
5081LM-3*	Medium Back Multi-Tilter (Leather)	\$1242
5090-4	High Back Tilter	\$552
5090LM-4	High Back Tilter (Leather)	\$1044
5091-4	Medium Back Tilter	\$518
5091LM-4	Medium Back Tilter (Leather)	\$951

*Not UPSable

For additional Synopsis models see page 13.

For specifications and dimensions see page 51.

Height Adjustable Stools

Pair these height adjustable stools and stool kits with Global's height adjustable tables for a truly comfortable ergonomic work environment.



Truform TS S5458-6 Medium Back Heavy Duty Height Adjustable Stool shown in Jenny, Ebony (JN02) with Height Adjustable Tables (page 83).



Stool Kit 2241
Height Adjustable Stool Kit with 6" Extension Tube
List Price **\$286**

For use with existing task chairs. Kit contains Black four-spoked footrest with chrome outer ring, extension tube and Black 26.5" chair base. Casters not included.



Stool Kit 2243
Height Adjustable Stool Kit with 10" Gas Cylinder
List Price **\$443**

For use with existing task chairs. Kit contains Black four-spoked footrest with chrome outer ring, 10" pneumatic gas cylinder and Black 26.5" chair base. Casters not included.



Truform TS S5458-6
Medium Back Heavy Duty Height Adjustable Stool
List Price **\$987**
Shown in Jenny, Ebony (JN02)

Available immediately in the following textile:



JN02 Ebony

2DAY LIGHTNING
SHIPS FROM THE FACTORY IN 2 DAYS!



Goal 2236-6
Height Adjustable Stool - Armless
List Price **\$421**
Shown in Fusion, Graphite (FU77)

Available immediately in the following textiles:



Fusion



FU83 Cobalt



FU85 Carbon

2DAY LIGHTNING
SHIPS FROM THE FACTORY IN 2 DAYS!

For specifications and dimensions see page 52.



Arno™

Perforated leather upholstery panels, one in the seat and one in the back.



Arno 4003
High Back Tilter
List Price **\$396**
Shown in Leather/Mock Leather (Grade 5), Black (550/450)

Arno 4004
Armchair
List Price **\$396**
Shown in Leather/Mock Leather (Grade 5), Black (550/450)

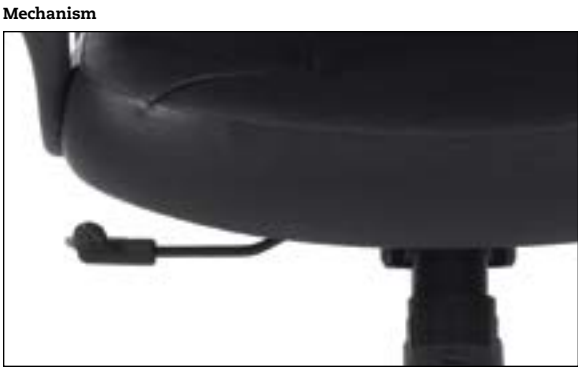

Tilter



Plastic Arm



Black (BK) Base



Perforated Leather

Available immediately in the following textile:

Leather/Mock Leather (Grade 5)



550/450 Black



For specifications and dimensions see page 51.

Concorde®

Concorde is a dual purpose chair; intended for both sophisticated executives and for challenging 24 hour environments that require deep comfort and adjustability.



Concorde 2424-18*
Executive 24 Hr High Back Synchro-Tilter
List Price **\$3226**
Shown in Prescott Leather (Grade 10), Black Ink (PD03)



Revolutionary push button controls located on the armrest provide state-of-the-art ergonomic adjustment for exceptional comfort and support.



Tilt Lock Adjustment, Seat Height Adjustment, Sliding Seat Adjustment, Back Height Adjustment

Available immediately in the following textile:

Prescott Leather (Grade 10)



PD03 Black Ink



For specifications and dimensions see page 52.

*Not UPSable

loungge + reception

Citi™

Each piece in the Citi series complements every other: sofas meld with coffee and end tables, lounge chairs and ottomans pair with sectional pieces, fabrics and finishes harmonize.



Citi 7877*
Three Seat Sofa
List Price **\$1809**
Shown in Leather/Mock
Leather, Black (550/450) with
Tungsten (TUN) legs.



Citi 7875*
Lounge Chair
List Price **\$1064**
Shown in Leather/Mock
Leather, Black (550/450) with
Tungsten (TUN) legs.



Citi 7885*
End Table with Laminate Top
List Price **\$580**
Shown in Black (BLK)
Laminate with Tungsten (TUN)
legs.



Citi 7876*
Two Seat Sofa
List Price **\$1437**
Shown in Leather/Mock
Leather, Black (550/450) with
Tungsten (TUN) legs.

Available immediately
in the following textile:

Leather/Mock Leather



550/450 Black

Citi 7876* (page 35) Two Seat Sofa shown in Leather/Mock Leather, Black (550/450).

For specifications and dimensions see page 53.
*Not UPSable



stack,
nesting +
guest



Spritz 6765C (page 40) Nesting Chair shown in Waterfall, Dance (WA54).

All seating is nationally stocked and available immediately or part of the 2DAY LIGHTNING program and ships within two business days.

Bakhita

This versatile polymer chair is UV and weather resistant and can be used in casual dining areas, educational facilities, meeting rooms, pool side, on patios and healthcare rooms.



Bakhita 6750
Stacking Armchair
List Price **\$220**
Shown in Alloy (ALY)

Bakhita 6751
Stacking Side Chair
List Price **\$195**
Shown in Alloy (ALY)



Bakhita 6754
Armless Bar Stool
List Price **\$295**
Shown in Alloy (ALY)

Bakhita + Spyker 6756
Dolly
List Price **\$260**

Available immediately in the following plastic finishes:



Spyker

A comfortable, high-quality, lightweight, stacking chair that is incredibly strong and durable. Spyker is an all polymer chair and is weather, UV and stain resistant.



Spyker 6790*
Stacking Armchair
List Price **\$195**
Shown in Alloy (ALY)
(Non UPSable)

Spyker 6790*
Stacking Armchair
List Price **\$195**
Shown in Char (CHA)
(Non UPSable)



Spyker 6791
Stacking Side Chair
List Price **\$175**
Shown in Alloy (ALY)

Spyker 6791
Stacking Side Chair
List Price **\$175**
Shown in Char (CHA)

Available immediately in the following plastic finishes:



*Not UPSable
For specifications and dimensions see page 54-55

2DAY LIGHTNING
SHIPS FROM THE FACTORY IN 2 DAYS!



Spritz 6765C Flip Up Seat Nesting Chair with Casters
Shown in Jenny, Harvest (JN29).
For available textiles, see pages 202-207.

Spritz 2DAY LIGHTNING models are available in Black mesh only.

Spritz™

Spritz offers an economical, versatile and highly durable choice for the workplace and learning environment.



Spritz 6765C
Flip Seat Nesting Chair with Casters
List Price **\$510**
Shown in Waterfall, Dance (WA54).



Available immediately in the following textile:

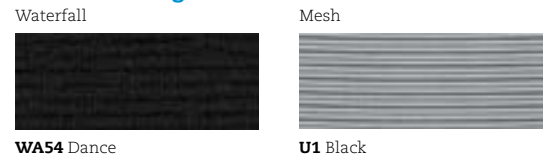

Roma®

Designed to do it all, Roma is the perfect “everywhere” chair.



Roma 1899
Mesh Back Nesting Armchair with Casters
List Price **\$567**
Shown in Urban, Black Coal (UR22).



Available immediately in the following textile:

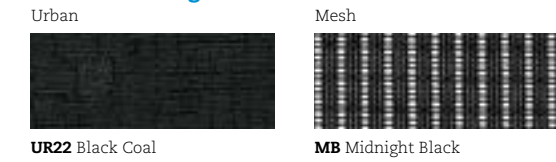

2DAY LIGHTNING
SHIPS FROM THE FACTORY IN 2 DAYS!



Roma 1899 Nesting Armchair with Casters
Shown in Match, Wave (MT26).
For available textiles, see pages 202-207.

Roma 2DAY LIGHTNING model is available in Black mesh only.

MODEL	DESCRIPTION	LIST PRICE (starting at)
1899	Nesting Armchair with Casters	\$567

For additional Roma model see page 19.

For specifications and dimensions see page 55.

2DAY LIGHTNING
SHIPS FROM THE FACTORY IN 2 DAYS!



Sidero 6900C Stacking Armchair with Casters
Shown in Terrace, Cherry Blossom (TC64).
For available textiles, see pages 202-207.



Sidero 6900
Stacking Armchair (shown stacked)
List Price **\$412**
Shown in Urban, Granite Rock (UR20)



Sidero 6901
Stacking Side Chair
List Price **\$372**
Shown in Urban, Granite Rock (UR20)

Available immediately in the following textiles:

Urban



UR20 Granite Rock **UR22 Black Coal**



MODEL	DESCRIPTION	LIST PRICE (starting at)
6900	Stacking Armchair	\$412
6900C	Stacking Armchair with Casters	\$469
6901	Stacking Side Chair	\$372
6901C	Stacking Side Chair with Casters	\$446
2125WS	Dolly	\$316



Popcorn 6711*
Armless Stacking Chair
List Price **\$160**
Shown in Cloud (IVC)

Popcorn 6715
Dolly (shown with 6711 in Cloud (IVC) stacked)
List Price **\$541**



Popcorn 6710*
Stacking Armchair
List Price **\$242**
Shown in Shadow (SHW)



Popcorn GC
Clear Glides (set of 2)
List Price **\$12**

Available immediately in the following plastic finishes:

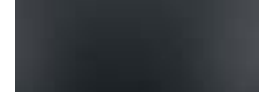
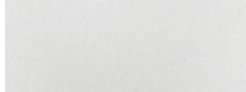
SHW Shadow **IVC Cloud**



2DAY LIGHTNING
SHIPS FROM THE FACTORY IN 2 DAYS!



Popcorn 6711* Armless Stacking Chair
Shown in Scarlet (SAR) with Polished Aluminum legs.

Popcorn 2DAY LIGHTNING models are available in five polypropylene colors:







Night (BLK) Cloud (IVC) Latte (LAB)
Scarlet (SAR) Shadow (SHW)

MODEL	LIST PRICE (starting at)
6710*	Stacking Armchair \$242
6711*	Armless Stacking Chair \$160
6715	Dolly \$541
6716	Clear Glides (set of 2) \$12

2DAY LIGHTNING
SHIPS FROM THE FACTORY IN 2 DAYS!



Sonic 6508 Armless Stacking Chair
Shown in Scarlet (SAR) with Polished Aluminum legs.

Sonic 2DAY LIGHTNING models are available in five polypropylene colors:



Sonic™



Sonic 6508
Armless Stacking Chair (shown stacked)
List Price **\$231**
Shown in Night (BLK)



Sonic 6508
Armless Stacking Chair
List Price **\$231**
Shown in Cloud (IVC)

Sonic 6513
Stacking Armchair
List Price **\$282**
Shown in Night (BLK)

Duet™



Duet 6620*
Stacking Armchair
List Price **\$257**
Shown in Night (BLK)



Duet 6621
Armless Stacking Chair
List Price **\$182**
Shown in Shadow (SHW)

Duet 6624
Dolly (shown with 6621 in Cloud (IVC) stacked)
List Price **\$541**

2DAY LIGHTNING
SHIPS FROM THE FACTORY IN 2 DAYS!



Duet 6621 Armless Stacking Chair
Shown in Latte (LAB) with Polished Aluminum legs.

Duet 2DAY LIGHTNING models are available in five polypropylene colors:



MODEL	DESCRIPTION	LIST PRICE (starting at)
6508	Armless Stacking Chair (Poly. Seat and Back)	\$231
6508MB	Armless Stacking Chair (Poly. Seat and Mesh Back)	\$277
6509	Armless Stacking Chair (Uph. Seat and Poly. Back)	\$267
6509MB	Armless Stacking Chair (Uph. Seat and Mesh Back)	\$312
6511	Armless Stacking Chair (Uph. Seat and Back)	\$300
6513	Stacking Armchair (Poly. Seat and Back)	\$282
6513MB	Stacking Armchair (Poly. Seat and Mesh)	\$326
6514	Stacking Armchair (Uph. Seat and Poly. Back)	\$315
6514MB	Stacking Armchair (Uph. Seat and Mesh Back)	\$362
6515	Stacking Armchair (Uph. Seat and Back)	\$345
6517WS	Dolly (Wall Saver)	\$402

(MB models feature a black mesh back)

Available immediately in the following plastic finishes:

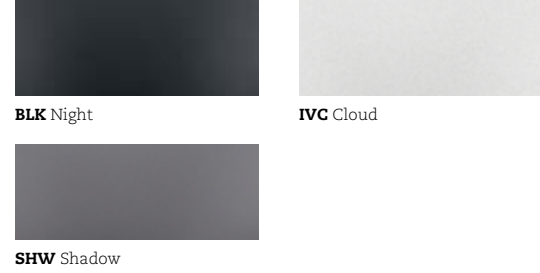

Available immediately in the following plastic finishes:

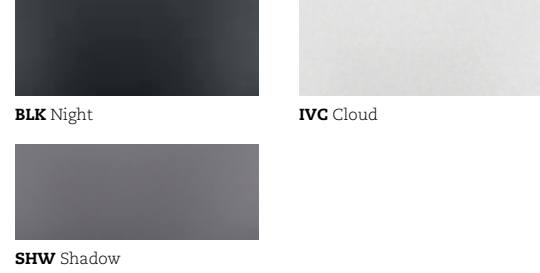

MODEL	DESCRIPTION	LIST PRICE (starting at)
6620*	Stacking Armchair (Poly. Seat and Back)	\$257
6621	Armless Stacking Chair (Poly. Seat and Back)	\$182
6624	Dolly	\$541

*Not UPSable
For specifications and dimensions see page 54.



Goal 2239-6 - page 22
 Low Back Task - Armless
 Dimensions: 25w x 24.5d x 39h
 Ergonomic Features: C, D, E, N

- Standard with a five-legged, injection molded "spider" base and C65 casters
- Base and frame available in Black (BK) only
- Fusion, Cobalt (FU83)
- Fusion, Granite (FU77)
- Fusion, Carbon (FU85)

List Price ***284**



Goal 2237-6 - page 22
 Low Back Task
 Dimensions: 25w x 24.5d x 39h
 Ergonomic Features: C, D, E, H, N

- Standard with adjustable height T-arms with curved urethane armcaps (3N) in Black only
- Standard with a five-legged, injection molded "spider" base and C65 casters
- Base and frame available in Black (BK) only
- Fusion, Cobalt (FU83)
- Fusion, Granite (FU77)
- Fusion, Carbon (FU85)

List Price ***368**



Goal 2237-5 - page 22
 Low Back Operator
 Dimensions: 25w x 22.5d x 36h
 Ergonomic Features: C, D, F, G, H, N

- Standard with adjustable height T-arms with curved urethane armcaps (3N) in Black only
- Standard with a five-legged, injection molded "spider" base and C65 casters
- Base and frame available in Black (BK) only
- Fusion, Cobalt (FU83)
- Fusion, Granite (FU77)
- Fusion, Carbon (FU85)

List Price ***442**



Graham 3144 - page 23
 Low Back Ergo-Tilter
 Dimensions: 25w x 26d x 37.5h
 Ergonomic Features: A, B, C, D, G, H, M, N, S

- Features a multi-curved backrest with an impact resistant outer back shell
- Standard with adjustable height T-arms with curved urethane armcaps (3N) in Black Only
- Standard with a five-legged, injection molded "spider" base and C10 casters
- Base and frame available in Black (BK) Only
- Fusion, Carbon (FU85)

List Price ***561**



Factor 5541-8 - page 6
 Mesh Medium Back Weight Sensing Synchro-Tilter
 Dimensions: 26.5w x 24d x 39h
 Ergonomic Features: A, B, C, D, E, H, L, M, N, U

- Pneumatic seat height adjustment
- Adjustable lumbar support
- Side activated sliding seat depth adjustment
- Height adjustable arms (U2)
- Cloud frame (IC)
- Fusion, Granite (FU77)
- Fusion, Carbon (FU85)

List Price ***640**



Factor 5540-8 - page 6
 Mesh High Back Weight Sensing Synchro-Tilter
 Dimensions: 26.5w x 24d x 41h
 Ergonomic Features: A, B, C, D, E, H, L, M, N, U

- Pneumatic seat height adjustment
- Adjustable lumbar support
- Side activated sliding seat depth adjustment
- Height adjustable arms (U2)
- Shadow frame (SH)
- Fusion, Granite (FU77)
- Fusion, Carbon (FU85)

List Price ***670**



Factor 5540-8 - page 6
 Mesh High Back Weight Sensing Synchro-Tilter
 Dimensions: 26.5w x 24d x 41h
 Ergonomic Features: A, B, C, D, E, H, L, M, N, U

- Pneumatic seat height adjustment
- Adjustable lumbar support
- Side activated sliding seat depth adjustment
- Height adjustable arms (U2)
- Cloud frame (IC)
- Fusion, Granite (FU77)
- Fusion, Carbon (FU85)

List Price ***670**



Tye 1951-4 - page 21
 Mesh Low Back Tilter
 Dimensions: 25w x 26d x 41h
 Ergonomic Features: A, C, E, H, M, N

- Contemporary mesh fabric and upholstered panels are used on chair backs
- Adjustable height T-arms with curved urethane armcaps (3N) in Black Only
- Five-legged, injection-molded "spider" base
- C65 casters are standard
- Seat depth and pneumatic seat height adjustments. Tilt tension adjustment with tilt lock
- Jenny, Ebony (JN02) and Mock Leather, Black (550)

List Price ***618**



Goal 2237-3 - page 22
 Low Back Multi-Tilter
 Dimensions: 25w x 22.5d x 36h
 Ergonomic Features: A, B, C, D, F, G, H, N, S

- Standard with adjustable height T-arms with curved urethane armcaps (3N) in Black only
- Standard with a five-legged, injection molded "spider" base and C65 casters
- Base and frame available in Black (BK) only
- Fusion, Cobalt (FU83)
- Fusion, Granite (FU77)
- Fusion, Carbon (FU85)

List Price ***562**



Factor 5541-8 - page 6
 Mesh Medium Back Weight Sensing Synchro-Tilter
 Dimensions: 26.5w x 24d x 39h
 Ergonomic Features: A, B, C, D, E, H, L, M, N, U

- Pneumatic seat height adjustment
- Adjustable lumbar support
- Side activated sliding seat depth adjustment
- Height adjustable arms (U2)
- Black frame (BK)
- Fusion, Granite (FU77)
- Fusion, Carbon (FU85)

List Price ***595**



Factor 5540-8 - page 6
 Mesh High Back Weight Sensing Synchro-Tilter
 Dimensions: 26.5w x 24d x 41h
 Ergonomic Features: A, B, C, D, E, H, L, M, N, U

- Pneumatic seat height adjustment
- Adjustable lumbar support
- Side activated sliding seat depth adjustment
- Height adjustable arms (U2)
- Black frame (BK)
- Fusion, Granite (FU77)
- Fusion, Carbon (FU85)

List Price ***625**



Factor 5541-8 - page 6
 Mesh Medium Back Weight Sensing Synchro-Tilter
 Dimensions: 26.5w x 24d x 39h
 Ergonomic Features: A, B, C, D, E, H, L, M, N, U

- Pneumatic seat height adjustment
- Adjustable lumbar support
- Side activated sliding seat depth adjustment
- Height adjustable arms (U2)
- Shadow frame (SH)
- Fusion, Granite (FU77)
- Fusion, Carbon (FU85)

List Price ***640**



Tye 1950-4 - page 21
 Mesh High Back Tilter
 Dimensions: 25w x 26d x 45.5h
 Ergonomic Features: A, C, E, H, M, N

- Contemporary mesh fabric and upholstered panels are used on chair backs
- Adjustable height T-arms with curved urethane armcaps (3N) in Black Only
- Five-legged, injection-molded "spider" base
- C65 casters are standard
- Seat depth and pneumatic seat height adjustments. Tilt tension adjustment with tilt lock
- Jenny, Ebony (JN02) and Mock Leather, Black (550)

List Price ***646**



Vion 6321-4C - page 9
 Mesh High Back Tilter with Fixed Arms (C)
 Dimensions: 25.5w x 24d x 39.25h
 Ergonomic Features: A, B, C, E, H, M, N, Q, S

- Pneumatic seat height adjustment
- Black five prong, injection molded, fiberglass reinforced nylon Governor base (B7) with dual wheel carpet casters (C1)
- Fixed "C" arm (Black)
- Urban, Granite Rock (UR20)
- Urban, Black Coal (UR22)

List Price ***656**



Vion 6322-8 - page 9
 Mesh Medium Back Weight Sensing Synchro-Tilter
 Dimensions: 25.5w x 24d x 38h
 Ergonomic Features: A, B, C, E, H, L, M, N, Q

- Pneumatic seat height adjustment
- Black five-prong, injection molded, fiberglass reinforced nylon Governor base (B7) with dual wheel carpet casters (C1)
- Height and width adjustable arms (AS) that feature a front to back sliding armcap
- Urban, Granite Rock (UR20)
- Urban, Black Coal (UR22)

List Price ***695**



Vion Fog 6321-0FAFG - page 11
 Mesh Medium Back Synchro-Tilter with Back Angle Adjustment
 Dimensions: 25.5w x 24d x 41.5h
 Ergonomic Features: A, B, C, E, G, H, L, M, N

- Pneumatic seat height adjustment
- Black five-prong, injection molded, fiberglass reinforced nylon Governor base (B7) with dual wheel carpet casters (C1)
- Height and width adjustable arms (AS) that feature a front to back sliding armcap
- Fog Frame
- Urban, Graphite (FU81)
- Fusion, Carbon (FU85)

List Price ***727**



A Tilt Tension
 Increase or decrease to match body weight. Allows you to rock comfortably, without heavy pushing, reducing muscle fatigue.

B Chair Tilt Lock
 Lock the tilt movement in position(s) to accommodate your working posture. Allows you to lock your chair in a comfortable and supportive position. (can be either single position or infinite style).

C Seat Height
 Raise or lower to allow your feet to rest flat on the floor. Avoids pressure under your thighs, easing blood flow.

D Back Height
 Raise or lower to position lumbar support in your lumbar area. Reduces likelihood of back pain.

E Seat Depth
 Change the depth of the seat to accommodate the length of your thighs. Keeps your back in contact with the backrest while avoiding pressure behind your knees.

G Back Angle
 Adjust to change the angle of your torso in relation to your thighs. Helps reduce disc pressure and relaxes your back muscles.

H Arm Height
 Raise or lower to support your forearms. Reduces muscular effort in neck and shoulders, minimizing risk of pain.



L Synchro-Tilt Movement
 Backrest reclines at a faster rate than the seat, increasing the angle between your torso and thighs. Enhances comfort and encourages dynamic body movement.

M Waterfall Seat Edge
 Reduces pressure at the back of the knee, contributing to good blood flow.

N Properly Contoured Cushions
 Support the body effectively, allowing you to sit longer without discomfort.

Q Width Adjustable Arms
 Allows outward movement of armrests to match shoulder breadth. Ensures armrests properly support forearms, reducing muscular effort in neck and shoulders.

R Arm Rotation
 Rotate armcap to support your forearm in various positions. Reduces muscular effort in neck and shoulders, minimizing risk of pain.

S Center-Tilt Movement
 Chair tilts from a pivot point under the center of the seat allowing you to rock. When your feet are well supported, blood flow is enhanced.

V Lumbar Depth Adjustment
 Increase or decrease curvature of the back to match the profile of your lower back. Enhances comfort and support in the lower lumbar area.



Vion Fog 6322-0FAFG - page 11
 Mesh Medium Back Synchro-Tilter with Back Angle Adjustment
 Dimensions: 25.5w x 24d x 39.5h
 Ergonomic Features: A, B, C, E, G, H, L, M, N

- Pneumatic seat height adjustment
- Black five-prong, injection molded, fiberglass reinforced nylon Governor base (B7) with dual wheel carpet casters (C1)
- Height and width adjustable arms (AS) that feature a front to back sliding armcap
- Fog Frame
- Fusion, Graphite (FU81)
- Fusion, Carbon (FU85)

List Price **\$727**



Vion 6321-8 - page 9
 Mesh High Back Weight Sensing Synchro-Tilter
 Dimensions: 25.5w x 24d x 40h
 Ergonomic Features: A, B, C, E, H, L, M, N, Q

- Pneumatic seat height adjustment
- Black five-prong, injection molded, fiberglass reinforced nylon Governor base (B7) with dual wheel carpet casters (C1)
- Height and width adjustable arms (AS) that feature a front to back sliding armcap
- Urban, Granite Rock (UR20)
- Urban, Black Coal (UR22)

List Price **\$733**



Graphic 2738MB - page 20
 Mesh Medium Posture Back
 Dimensions: 25w x 24d x 36h
 Ergonomic Features: A, C, G, H, M, N, Q

- Pneumatic seat height adjustment
- Generous compound curved back and seat
- Breathable black mesh back
- Adjustable height, forward swept arms and "sliding armcaps" (G4)
- Width adjustable arms
- Two-position tilt lock adjustment and tilt tension control
- Five-legged, injection molded, fiberglass reinforced nylon arched base with (C1) casters in Black
- Replay, Coal (RP34)

List Price **\$660**



Truform 5451-3 - page 16
 Medium Back Multi-Tilter
 Dimensions: 26w x 25d x 38.5h
 Ergonomic Features: A, B, C, D, F, G, H, M, N, Q, S

- Pneumatic seat height adjustment
- Standard with adjustable height arms (SC)
- Jenny, Ebony (JN02)

List Price **\$680**



Truform 5451-8 - page 16
 Medium Back Weight Sensing Multi-Tilter
 Dimensions: 26w x 25d x 38h
 Ergonomic Features: A, B, C, E, H, M, N, Q

- Pneumatic seat height adjustment
- Standard with adjustable height arms (SC)
- Jenny, Ebony (JN02)

List Price **\$680**



Truform 5450-3 - page 16
 High Back Multi-Tilter
 Dimensions: 26w x 25d x 42h
 Ergonomic Features: A, B, C, D, F, G, H, M, N, Q, S

- Pneumatic seat height adjustment
- Standard with adjustable height arms (SC)
- Jenny, Ebony (JN02)

List Price **\$709**



Truform 5450-8 - page 16
 High Back Weight Sensing Multi-Tilter
 Dimensions: 26w x 25d x 41.5h
 Ergonomic Features: A, B, C, E, H, M, N, Q

- Pneumatic seat height adjustment
- Standard with adjustable height arms (SC)
- Jenny, Ebony (JN02)

List Price **\$709**



Truform TS5451-3 - page 17
 Medium Back Multi-Tilter Heavy Duty
 Dimensions: 26w x 25d x 38.5h
 Ergonomic Features: A, B, C, D, F, G, H, M, N, Q, S

- Pneumatic seat height adjustment
- Standard with adjustable height arms (SC)
- Jenny, Ebony (JN02)

List Price **\$803**



Truform TS5450-3 - page 17
 High Back Multi-Tilter Heavy Duty
 Dimensions: 26w x 25d x 42h
 Ergonomic Features: A, B, C, D, F, G, H, M, N, Q, S

- Pneumatic seat height adjustment
- Standard with adjustable height arms (SC)
- Jenny, Ebony (JN02)

List Price **\$832**



Roma 1906 - page 19
 Mesh Medium Back Task
 Dimensions: 25.5w x 23.5d x 38h
 Ergonomic Features: A, G, M, N

- Pneumatic seat height adjustment
- Arms are durable fiberglass reinforced Nylon, fixed height. Armcaps are durable Polyurethane (SSU)
- Exclusive chair control mechanism allows the chair back and arms to recline together, while the chair seat moves just enough to ensure comfort
- Black five-prong fiberglass reinforced Nylon base
- (C1) casters are standard
- Urban, Black Coal (UR22)

List Price **\$700**



Granada 3212 - page 15
 Low Back Multi-Tilter
 Dimensions: 26w x 24d x 40h
 Ergonomic Features: A, B, C, D, E, F, G, H, M, N, Q, S

- Pneumatic seat height adjustment
- Standard with adjustable height T-arms with curved urethane armcaps (3N) in Black Only
- Waterfall, Grand (WA50)
- Waterfall, Dance (WA54)

List Price **\$754**



Granada 3217 - page 15
 High Back Multi-Tilter
 Dimensions: 26w x 24.5d x 43h
 Ergonomic Features: A, B, C, D, E, F, G, H, M, N, Q, S

- Pneumatic seat height adjustment
- Standard with adjustable height T-arms with curved urethane armcaps (3N) in Black Only
- Waterfall, Grand (WA50)
- Waterfall, Dance (WA54)

List Price **\$847**



Loover 2662-8 - page 18
 Mesh Medium Back Weight Sensing Synchro-Tilter
 Dimensions: 25.5w x 25d x 39h
 Ergonomic Features: A, B, C, E, H, L, M, N, Q

- Pneumatic seat height adjustment
- Black five-prong, injection molded, fiberglass reinforced nylon Governor base (B7) with dual wheel carpet casters (C1)
- Height and width adjustable arms (AS) that feature a front to back sliding armcap
- Urban, Granite Rock (UR20)
- Urban, Black Coal (UR22)

List Price **\$760**



Loover 2661-8 - page 18
 Mesh High Back Weight Sensing Synchro-Tilter
 Dimensions: 25.5w x 24d x 42.5h
 Ergonomic Features: A, B, C, E, H, L, M, N, Q

- Pneumatic seat height adjustment
- Black five-prong, injection molded, fiberglass reinforced nylon Governor base (B7) with dual wheel carpet casters (C1)
- Height and width adjustable arms (AS) that feature a front to back sliding armcap
- Urban, Granite Rock (UR20)
- Urban, Black Coal (UR22)

List Price **\$795**



Synopsis 5081-3 - page 13
 Medium Back Multi-Tilter
 Dimensions: 25w x 24d x 41h
 Ergonomic Features: A, B, C, D, E, G, M, N, Q, S

- Adjustable height T arms with teardrop shaped urethane armcaps (3B)
- Ratchet style back height and pneumatic seat height adjustments
- Vari-Width (WA), Width adjustable arm extensions are standard with adjustable height T arms
- Impact resistant outer back shell
- Sliding seat depth adjustment
- Urban, Granite Rock (UR20)
- Urban, Black Coal (UR22)

List Price **\$800**



Synopsis 5080-3 - page 13
 High Back Multi-Tilter
 Dimensions: 25w x 24d x 41h
 Ergonomic Features: A, B, C, D, E, G, M, N, Q, S

- Adjustable height T arms with teardrop shaped urethane armcaps (3B)
- Ratchet style back height and pneumatic seat height adjustments
- Vari-Width (WA), Width adjustable arm extensions are standard with adjustable height T arms
- Impact resistant outer back shell
- Sliding seat depth adjustment
- Urban, Granite Rock (UR20)
- Urban, Black Coal (UR22)

List Price **\$884**



A Tilt Tension
 Increase or decrease to match body weight. Allows you to rock comfortably, without heavy pushing, reducing muscle fatigue.



B Chair Tilt Lock
 Lock the tilt movement in position(s) to accommodate your working posture. Allows you to lock your chair in a comfortable and supportive position. (can be either single position or infinite style).



C Seat Height
 Raise or lower to allow your feet to rest flat on the floor. Avoids pressure under your thighs, easing blood flow.



D Back Height
 Raise or lower to position lumbar support in your lumbar area. Reduces likelihood of back pain.



E Seat Depth
 Change the depth of the seat to accommodate the length of your thighs. Keeps your back in contact with the backrest while avoiding pressure behind your knees.



G Back Angle
 Adjust to change the angle of your torso in relation to your thighs. Helps reduce disc pressure and relaxes your back muscles.



H Arm Height
 Raise or lower to support your forearms. Reduces muscular effort in neck and shoulders, minimizing risk of pain.



L Synchro-Tilt Movement
 Backrest reclines at a faster rate than the seat, increasing the angle between your torso and thighs. Enhances comfort and encourages dynamic body movement.



M Waterfall Seat Edge
 Reduces pressure at the back of the knee, contributing to good blood flow.



N Properly Contoured Cushions
 Support the body effectively, allowing you to sit longer without discomfort.



Q Width Adjustable Arms
 Allows outward movement of armrests to match shoulder breadth. Ensures armrests properly support forearms, reducing muscular effort in neck and shoulders.



R Arm Rotation
 Rotate armcap to support your forearm in various positions. Reduces muscular effort in neck and shoulders, minimizing risk of pain.



S Center-Tilt Movement
 Chair tilts from a pivot point under the center of the seat allowing you to rock. When your feet are well supported, blood flow is enhanced.



V Lumbar Depth Adjustment
 Increase or decrease curvature of the back to match the profile of your lower back. Enhances comfort and support in the lower lumbar area.



G1 Ergo Select 7331 - page 14

Medium Back Weight Sensing Synchro-Tilter

Dimensions: 24w x 21.5d x 42h

Ergonomic Features: A, B, C, D, E, L, M, N, Q, T

- Pneumatic seat height, forward and rearward seat tilt with infinite lock, free floating back angle control, tilt tension control and side activated sliding seat depth
- Stitch detail on edges of seat and back is discrete, using matched thread as standard
- Height and width adjustable arms with sliding armcaps (G5)
- Waterfall, Dance (WA54)

List Price ***953**



G1 Ergo Select 7332 - page 14

High Back Weight Sensing Synchro-Tilter

Dimensions: 24.5w x 23d x 45.5h

Ergonomic Features: A, B, C, D, E, L, M, N, Q, T

- Pneumatic seat height, forward and rearward seat tilt with infinite lock, free floating back angle control, tilt tension control and side activated sliding seat depth.
- Stitch detail on edges of seat and back is discrete, using matched thread as standard.
- Height and width adjustable arms with sliding armcaps (G5)
- Waterfall, Dance (WA54)

List Price ***1005**



Aspen 2852-3 - page 12

Medium Back Multi-Tilter

Dimensions: 25w x 24d x 37h

Ergonomic Features: A, B, C, D, E, F, G, H, M, N, Q, S

- Ratchet back height adjustment.
- Height and width adjustable arms (AS) that feature a sliding armcap
- Seat depth adjustment
- Jenny, Charcoal (JN11)

List Price ***975**



Aspen 2851-3 - page 12

High Back Multi-Tilter

Dimensions: 25w x 24d x 41h

Ergonomic Features: A, B, C, D, E, F, G, H, M, N, Q, S

- Ratchet back height adjustment.
- Height and width adjustable arms (AS) that feature a sliding armcap.
- Seat depth adjustment
- Jenny, Charcoal (JN11)

List Price ***1004**



Arno 4003 - page 32

High Back Tilter

Dimensions: 25w x 29d x 42h

Ergonomic Features: A, B, C, N, S

- Perforated leather inserts in the seat and back surfaces
- Standard Black (BK) molded flared loop arms and a five-legged injection molded base with (C65) casters.
- Leather/Mock Leather, Black (550/450)

List Price ***396**



Synopsis 5091-4 - page 30

Medium Back Tilter

Dimensions: 24.5w x 26.5d x 39.5h

Ergonomic Features: A, B, C, M, N, S

- Ratchet style back height and pneumatic seat height adjustments
- Impact resistant outer back shell.
- Sliding seat depth adjustment
- Urban, Granite Rock (UR20)
- Urban, Black Coal (UR22)

List Price ***518**



Synopsis 5090-4 - page 30

High Back Tilter

Dimensions: 24.5w x 26.5d x 43.5h

Ergonomic Features: A, B, C, M, N, S

- Ratchet style back height and pneumatic seat height adjustments
- Impact resistant outer back shell.
- Sliding seat depth adjustment
- Urban, Granite Rock (UR20)
- Urban, Black Coal (UR22)

List Price ***552**



Solar 8456 - page 29

Medium Back Mesh Tilter

Dimensions: 23.25w x 25d x 36h

Ergonomic Features: A, B, C, D, E, H, L, M, N, U

- One piece molded frame is extremely light (chair weighs 24 lbs) and exceeds BIFMA standard for commercial applications
- Cascading forward seat surface and reverse edge
- Integrated seat height adjustment lever is intuitive and easy to utilize
- The under seat structure maintains the seamless and fluid aesthetic that defines Solar
- (C1) casters are standard
- Mesh, Storm (STM)
- Plastic, Asphalt (APT)

List Price ***800**



Solar 8457 - page 29

Medium Back Mesh Tilter

Dimensions: 23.25w x 25d x 36h

Ergonomic Features: A, B, C, D, E, H, L, M, N, U

- One piece molded frame is extremely light (chair weighs 24 lbs) and exceeds BIFMA standard for commercial applications
- Cascading forward seat surface and reverse edge
- Integrated seat height adjustment lever is intuitive and easy to utilize
- The under seat structure maintains the seamless and fluid aesthetic that defines Solar
- (C1) casters are standard
- Mesh, Midnight (MDN)
- Plastic, Alabaster (ABR)

List Price ***877**



Luray 6462 - page 27

Low Back Tilter

Dimensions: 25w x 25d x 39.5h

Ergonomic Features: A, B, C, M, N, S, U

- Stitch detail on edges of seat and back is discrete, using matched thread as standard
- Standard with Global's high quality Soft Descent™ pneumatic lift
- Five prong, injection molded, fiberglass reinforced, nylon medium rise base (B7B) with (C1) dual wheel carpet casters
- Terrace, Ironwork (TC71)
- Allante FRee, Ink (A16F)

List Price (Terrace Fabric - Grade 1) ***890**

List Price (Allante FRee Vinyl - Grade 2) ***941**



Luray 6461 - page 27

High Back Tilter

Dimensions: 25w x 25d x 42.5h

Ergonomic Features: A, B, C, M, N, S, U

- Stitch detail on edges of seat and back is discrete, using matched thread as standard
- Standard with Global's high quality Soft Descent™ pneumatic lift
- Five prong, injection molded, fiberglass reinforced, nylon medium rise base (B7B) with (C1) dual wheel carpet casters
- Terrace, Ironwork (TC71)
- Allante FRee, Ink (A16F)

List Price (Terrace Fabric - Grade 1) ***918**

List Price (Allante FRee Vinyl - Grade 2) ***974**



Global Accord 2671-4 - page 26

Medium Back Tilter

Dimensions: 25w x 25d x 37h

Ergonomic Features: A, B, C, M, N, S, U

- Features a sling back style that molds to and evenly supports the back and spine
- Cast aluminum with a mirror finish accent the arms and base
- Soft touch self-skinned urethane armcaps are available in Black Only.
- Standard with an arched aluminum spider base and (C1) casters
- Allante FRee, Ink (A16F)
- Allante FRee, Gibraltar (A12F)

List Price ***929**



- A Tilt Tension**
Increase or decrease to match body weight. Allows you to rock comfortably, without heavy pushing, reducing muscle fatigue.
- B Chair Tilt Lock**
Lock the tilt movement in position(s) to accommodate your working posture. Allows you to lock your chair in a comfortable and supportive position. (can be either single position or infinite style).
- C Seat Height**
Raise or lower to allow your feet to rest flat on the floor. Avoids pressure under your thighs, easing blood flow.
- D Back Height**
Raise or lower to position lumbar support in your lumbar area. Reduces likelihood of back pain.
- E Seat Depth**
Change the depth of the seat to accommodate the length of your thighs. Keeps your back in contact with the backrest while avoiding pressure behind your knees.
- G Back Angle**
Adjust to change the angle of your torso in relation to your thighs. Helps reduce disc pressure and relaxes your back muscles.
- H Arm Height**
Raise or lower to support your forearms. Reduces muscular effort in neck and shoulders, minimizing risk of pain.



- L Synchro-Tilt Movement**
Backrest reclines at a faster rate than the seat, increasing the angle between your torso and thighs. Enhances comfort and encourages dynamic body movement.
- M Waterfall Seat Edge**
Reduces pressure at the back of the knee, contributing to good blood flow.
- N Properly Contoured Cushions**
Support the body effectively, allowing you to sit longer without discomfort.
- Q Width Adjustable Arms**
Allows outward movement of armrests to match shoulder breadth. Ensures armrests properly support forearms, reducing muscular effort in neck and shoulders.
- R Arm Rotation**
Rotate armcap to support your forearm in various positions. Reduces muscular effort in neck and shoulders, minimizing risk of pain.
- S Center-Tilt Movement**
Chair tilts from a pivot point under the center of the seat allowing you to rock. When your feet are well supported, blood flow is enhanced.
- V Lumbar Depth Adjustment**
Increase or decrease curvature of the back to match the profile of your lower back. Enhances comfort and support in the lower lumbar area.



Global Accord 2670-4 - page 26

High Back Tilter
 Dimensions: 25w x 25d x 44h
 Ergonomic Features: A, B, C, M, N, S, U
 • Features a sling back style that molds to and evenly supports the back and spine
 • Cast aluminum with a mirror finish accent the arms and base
 • Soft touch self-skinned urethane armcaps are available in Black Only.
 • Standard with an arched aluminum spider base and (C1) casters
 • Allante FRee, Ink (A16F)
 • Allante FRee, Gibraltar (A12F)
 List Price **\$959**



Concorde 2424-18 - page 33

24 Hr High Back Synchro-Tilter
 Dimensions: 28.5w x 27d x 50h
 Ergonomic Features: A, B, C, D, E, L, M, N, Q, T
 • Seat cushion with Velcro attachment is easily removed and replaced
 • Rated for Multi-Shift use for persons up to 350 pounds
 • Pneumatic seat height adjustment and 5 - position tilt lock. Tilt tension control
 • Ratchet style back height adjustment
 • Standard with a reinforced five-legged, injection molded base with (C10) casters, Black (BK) Only
 • Prescott, Black Ink (PD03)
 List Price **\$3226**



Drafting 2241 - page 31

Drafting Stool Kit
 • Stool kit with 6" extension tube
 • Contains Black four-spoked footrest with chrome outer ring, extension tube and Black 26.5" chair base
 • For use with existing task chairs
 • Casters not included
 List Price **\$286**



Drafting 2243 - page 31

Drafting Stool Kit
 • Stool kit with 10" gas cylinder
 • Contains Black four-spoked footrest with chrome outer ring, 10" gas cylinder and Black 26.5" chair base.
 • For use with existing task chairs
 • Casters not included
 List Price **\$443**



Goal 2236-6 - page 31

Drafting Stool - Armless
 Dimensions: 20.5w x 24.5d x 48h
 Ergonomic Features: C, D, H, N
 • Standard with a five-legged, injection molded "spider" base and (C65) casters
 • Base and frame available in Black (BK) only
 • Fusion, Cobalt (FU83)
 • Fusion, Granite (FU77)
 • Fusion, Carbon (FU85)
 List Price **\$421**



Truform TS S5548-6 - pages 17, 31

Medium Back Heavy Duty Drafting Chair
 Dimensions: 26w x 25d x 43h
 Ergonomic Features: A, B, C, J, M, N
 • Pneumatic seat height adjustment
 • Standard with adjustable height arms (SC)
 • Jenny, Ebony (JN02)
 List Price **\$987**



A Tilt Tension
 Increase or decrease to match body weight. Allows you to rock comfortably, without heavy pushing, reducing muscle fatigue.



B Chair Tilt Lock
 Lock the tilt movement in position(s) to accommodate your working posture. Allows you to lock your chair in a comfortable and supportive position. (can be either single position or infinite style).



C Seat Height
 Raise or lower to allow your feet to rest flat on the floor. Avoids pressure under your thighs, easing blood flow.



D Back Height
 Raise or lower to position lumbar support in your lumbar area. Reduces likelihood of back pain.



E Seat Depth
 Change the depth of the seat to accommodate the length of your thighs. Keeps your back in contact with the backrest while avoiding pressure behind your knees.



G Back Angle
 Adjust to change the angle of your torso in relation to your thighs. Helps reduce disc pressure and relaxes your back muscles.



H Arm Height
 Raise or lower to support your forearms. Reduces muscular effort in neck and shoulders, minimizing risk of pain.



L Synchro-Tilt Movement
 Backrest reclines at a faster rate than the seat, increasing the angle between your torso and thighs. Enhances comfort and encourages dynamic body movement.



M Waterfall Seat Edge
 Reduces pressure at the back of the knee, contributing to good blood flow.



N Properly Contoured Cushions
 Support the body effectively, allowing you to sit longer without discomfort.



Q Width Adjustable Arms
 Allows outward movement of armrests to match shoulder breadth. Ensures armrests properly support forearms, reducing muscular effort in neck and shoulders.



R Arm Rotation
 Rotate armcap to support your forearm in various positions. Reduces muscular effort in neck and shoulders, minimizing risk of pain.



S Center-Tilt Movement
 Chair tilts from a pivot point under the center of the seat allowing you to rock. When your feet are well supported, blood flow is enhanced.



V Lumbar Depth Adjustment
 Increase or decrease curvature of the back to match the profile of your lower back. Enhances comfort and support in the lower lumbar area.



Citi 7885 - page 35
 End Table with Laminate Top
 Dimensions: 24w x 20d x 20h
 • Compact, contemporary design includes raised legs
 • Laminate, Black (BLK)
 List Price **\$580**



Citi 7875 - page 35
 Lounge Chair
 Dimensions: 30w x 31d x 30h
 • Compact, contemporary design includes raised legs
 • Fully upholstered. Fixed seat and back cushions. Raised metal tubular legs
 • Horizontal stitch detail
 • Leather/Mock Leather, Black (550/450)
 List Price **\$1064**



Citi 7876 - page 35
 Two Seat Sofa
 Dimensions: 50.5w x 31d x 30h
 • Compact, contemporary design includes raised legs
 • Fully upholstered. Fixed seat and back cushions. Raised metal tubular legs
 • Horizontal stitch detail
 • Leather/Mock Leather, Black (550/450)
 List Price **\$1437**



Citi 7877 - page 35
 Three Seat Sofa
 Dimensions: 72w x 31d x 30h
 • Compact, contemporary design includes raised legs
 • Fully upholstered. Fixed seat and back cushions. Raised metal tubular legs
 • Horizontal stitch detail
 • Leather/Mock Leather, Black (550/450)
 List Price **\$1809**



Duet 6621 - page 45
Stacking Side Chair - Armless
Dimensions: 20.75w x 22.75d x 33.25h

- Clear polycarbonate glides (CG) are standard and suitable for carpet, rubber or concrete flooring
- Weight capacity for this series is 300 lbs.
- Night (BLK)
- Cloud (IVC)
- Shadow (SHW)

List Price ***182**



Duet 6620 - page 45
Stacking Armchair
Dimensions: 25.5w x 22.75d x 33.25h

- Clear polycarbonate glides (CG) are standard and suitable for carpet, rubber or concrete flooring
- Weight capacity for this series is 300 lbs.
- Night (BLK)
- Cloud (IVC)
- Shadow (SHW)

List Price ***257**



Popcorn 6711 - page 43
Stacking Side Chair - Armless
Dimensions: 20w x 23.5d x 32.5h

- Chair frame is constructed of 1/2" diameter solid chrome steel rod
- Wall saver frame design; the base touches the wall before the upper back to protect the wall from damage
- Upper back features a cut out hand hold to assist in stacking and transportation
- Seat and back is a one piece polypropylene shell
- Night (BLK)
- Cloud (IVC)
- Shadow (SHW)

List Price ***160**



Popcorn 6710 - page 43
Stacking Armchair
Dimensions: 24.5w x 23.5d x 32.5h

- Chair frame is constructed of 1/2" diameter solid chrome steel rod
- Wall saver frame design; the base touches the wall before the upper back to protect the wall from damage
- Upper back features a cut out hand hold to assist in stacking and transportation
- Seat and back is a one piece polypropylene shell
- Night (BLK)
- Cloud (IVC)
- Shadow (SHW)

List Price ***242**



Spyker 6790 - page 39
Stacking Armchair
Dimensions: 17.91w x 20.86d x 31.29h

- All polymer chair intended for use indoors or outdoors. Weather resistant, UV resistant, stain resistant
- Chair legs are equipped with translucent non-marking glides as standard
- Alloy (ALY)
- Char (CHA)

List Price ***195**



Sonic 6508 - page 44
Stacking Side Chair - Armless
Dimensions: 21.5w x 21.5d x 33h

- Standard with a straight leg
- Standard with Chrome (CH) legs
- Night (BLK)
- Cloud (IVC)
- Shadow (SHW)

List Price ***231**



Sonic 6513 - page 44
Stacking Armchair
Dimensions: 23w x 21.5d x 33h

- Standard with a straight leg
- Standard with Chrome (CH) legs
- Night (BLK)
- Cloud (IVC)
- Shadow (SHW)

List Price ***282**



Sidero 6901 - page 42
Stacking Side Chair - Armless
Dimensions: 21w x 24d x 33h

- The back of the chair is compound curved to provide comfort and support
- Four legged models can be stacked 5 high on the floor
- Standard glide is a durable Black Polypropylene foot
- Urban, Granite Rock (UR20)
- Urban, Black Coal (UR22)

List Price ***372**



Bakhita 6751 - page 39
Stacking Side Chair - Armless
Dimensions: 18w x 21d x 31.5h

- All polymer chair intended for use indoors or outdoors. Weather resistant, UV resistant, stain resistant
- Inside is a structural nylon frame for strength. Outside is a durable polypropylene light fast compound
- Chair legs are equipped with translucent non-marking glides as standard
- Alloy (ALY)
- Char (CHA)
- Milk (MLK)
- Sandbar (SAN)

List Price ***195**



Bakhita 6750 - page 39
Stacking Armchair
Dimensions: 22.5w x 21d x 31.5h

- All polymer chair intended for use indoors or outdoors. Weather resistant, UV resistant, stain resistant
- Inside is a structural nylon frame for strength. Outside is a durable polypropylene light fast compound
- Chair legs are equipped with translucent non-marking glides as standard
- Alloy (ALY)
- Char (CHA)
- Milk (MLK)
- Sandbar (SAN)

List Price ***220**



Bakhita 6754 - page 39
Stacking Stool - Armless
Dimensions: 19.25w x 18.75d x 40.5h

- All polymer chair intended for use indoors or outdoors. Weather resistant, UV resistant, stain resistant
- Inside is a metal frame for strength. Outside is a durable polypropylene light fast compound
- Chair legs are equipped with translucent non-marking glides as standard
- Alloy (ALY)
- Char (CHA)
- Milk (MLK)
- Sandbar (SAN)

List Price ***295**



Spyker 6791 - page 39
Stacking Side Chair - Armless
Dimensions: 17.91w x 20.86d x 31.29h

- All polymer chair intended for use indoors or outdoors. Weather resistant, UV resistant, stain resistant
- Chair legs are equipped with translucent non-marking glides as standard
- Alloy (ALY)
- Char (CHA)

List Price ***175**



Arno 4004 - page 32
High Back Tilter
Dimensions: 25w x 29d x 42h
Ergonomic Features: A, B, C, N, S

- Perforated leather inserts in the seat and back surfaces
- Standard Black (BK) molded flared loop arms
- Leather/Mock Leather, Black (550/450)

List Price ***396**



Sidero 6900 - page 42
Stacking Armchair
Dimensions: 25.5w x 24d x 33h

- Wide curved arms and a round tubular steel frame, with wall save construction
- Arms are 2 1/8 inches wide and full length, and are made from incredibly strong fiberglass reinforced nylon
- The back of the chair is compound curved to provide comfort and support
- Four legged models can be stacked 5 high on the floor
- Standard glide is a durable Black Polypropylene foot.
- Urban, Granite Rock (UR20)
- Urban, Black Coal (UR22)

List Price ***412**



Spritz 6765C - page 40
Flip Seat Nesting Chair with Casters
Dimensions: 23.75w x 23d x 33h
Ergonomic Features: G, M, N

- Translucent mesh and models for all applications.
- Features an auto-adjusting comfort back that reacts to body pressure and articulates 12°.
- Flip up seat allowing chairs to nest horizontally.
- Waterfall, Dance (WA54)

List Price ***510**



Roma 1899 - page 19, 41
Mesh Back Nesting Armchair
Dimensions: 24.5w x 23.6d x 36h
Ergonomic Features: M, N

- The horizontal nesting chairs are easy to store. Simply flip the seat upward and then roll into nesting position, like a shopping cart.
- Arms are durable fiberglass reinforced nylon, fixed height. Armcaps are durable polyurethane (SSU), soft and warm to the touch.
- Stocked in Black (BLK).
- (C1) casters are standard.
- Urban, Black Coal (UR22)

List Price ***567**



A Tilt Tension
Increase or decrease to match body weight. Allows you to rock comfortably, without heavy pushing, reducing muscle fatigue.



B Chair Tilt Lock
Lock the tilt movement in position(s) to accommodate your working posture. Allows you to lock your chair in a comfortable and supportive position. (can be either single position or infinite style).



C Seat Height
Raise or lower to allow your feet to rest flat on the floor. Avoids pressure under your thighs, easing blood flow.



D Back Height
Raise or lower to position lumbar support in your lumbar area. Reduces likelihood of back pain.



E Seat Depth
Change the depth of the seat to accommodate the length of your thighs. Keeps your back in contact with the backrest while avoiding pressure behind your knees.



G Back Angle
Adjust to change the angle of your torso in relation to your thighs. Helps reduce disc pressure and relaxes your back muscles.



H Arm Height
Raise or lower to support your forearms. Reduces muscular effort in neck and shoulders, minimizing risk of pain.



L Synchro-Tilt Movement
Backrest reclines at a faster rate than the seat, increasing the angle between your torso and thighs. Enhances comfort and encourages dynamic body movement.



M Waterfall Seat Edge
Reduces pressure at the back of the knee, contributing to good blood flow.



N Properly Contoured Cushions
Support the body effectively, allowing you to sit longer without discomfort.



Q Width Adjustable Arms
Allows outward movement of armrests to match shoulder breadth. Ensures armrests properly support forearms, reducing muscular effort in neck and shoulders.



R Arm Rotation
Rotate armcap to support your forearm in various positions. Reduces muscular effort in neck and shoulders, minimizing risk of pain.



S Center-Tilt Movement
Chair tilts from a pivot point under the center of the seat allowing you to rock. When your feet are well supported, blood flow is enhanced.



V Lumbar Depth Adjustment
Increase or decrease curvature of the back to match the profile of your lower back. Enhances comfort and support in the lower lumbar area.

2day



lightning



Spritz Nester – 2 models available

Novello – 4 models available

Factor – 2 models available

Global's 2DAY LIGHTNING program offers many of our best selling models upholstered in your choice of our most popular textiles.

The 2DAY LIGHTNING program features easy customization with extensive upholstery choices. Global's lightning fast production and shipping make it simple to order and ideal for tight deadlines!

Need quick, simple and custom seating? Think Global!



Work + Task



Factor (maximum 50)
5540-8
5541-8

Black Mesh + Frame / U2 Arms only



Goal (maximum 50)

- 2235-6
- 2236-6
- 2237-3
- 2237-5
- 2237-6
- 2239-6



Graham (maximum 50)

3144



Granada Deluxe (maximum 50)

- 1170-3
- 1171-3
- TS1170-3
- TS1171-3



Graphic (maximum 50)

- 2736MB
- 2737
- 2738
- 2738MB
- 2739

Black Mesh only



Loover (maximum 50)

- 2661-0 2661-3 2661-4
- 2661-8 2662-0 2662-3
- 2662-4 2662-8

5 Vue Mesh Colors:
Coal Black (VU19), Desert Sand (VU11),
Quarry Grey (VU15), Sandy Beach (VU10)
Tidal Wave (VU16)



Roma (maximum 50)

- 1901
- 1906
- 1906RA

Black Mesh only



Supra X (maximum 50)

- 5333-3
- 5336-1
- 5336-3
- 5337-6
- 5338-6
- 5339-6



Triumph (maximum 50)

- 3650-3
- 3650-8
- 3651-3
- 3651-8



Truform (maximum 50)

- 5450-0 5450-3 5450-4
- 5450-8 5451-0 5451-3
- 5451-4 5451-8 5457-6
- 5458-6 S5457-6 S5458-6
- TS5450-3 TS5451-3



Weev (maximum 50)

- 2220-3
- 2220-4
- 2220-8
- 2221-3
- 2221-4
- 2221-8

Black Mesh only



Work + Task



Vion (maximum 50)

6321-0	6321-3	6321-4	6321-8	6322-0	6322-3	6322-4
6322-8	6324	6324C	6325	6325C	6327-6	6328-6
TS6321-3	TS6322-3	6331-0	6331-3	6331-4	6331-8	6332-0
6332-3	6332-4	6332-8	6335			

5 Vion Mesh Colors:
Black (MS69), Blue (MS72), Natural (MS74), Stone (MS71), Rope (MS73)



Vion Fog (maximum 50)

6321-0FAFG	6321-3FAFG	6321-4FAFG	6321-8FAFG	6322-0FAFG
6322-3FAFG	6322-4FAFG	6322-8FAFG	6324FO	6324CFO
6325FO	6325CFO	6327-6FAFG	6328-6FAFG	TS6321-3FAFG
TS6322-3FAFG	6331-0FAFG	6331-3FAFG	6331-4FAFG	6331-8FAFG
6332-0FAFG	6332-3FAFG	6332-4FAFG	6332-8FAFG	6335FO

5 Vion Mesh Colors:
Black (MS69), Blue (MS72), Natural (MS74), Stone (MS71), Rope (MS73)

Conference + Management



Global Accord (maximum 50)

2670-2	2670-4	2670LM-2
2670LM-4	2671-2	2671-4
2671LM-2	2671LM-4	2672-6
2672LM-6		



Global Accord Mesh (maximum 50)

2676-2	2676-4	2676LM-2
2676LM-4	2677-2	2677-4
2678-6	2677LM-2	2677LM-4
2678LM-6		

5 Vue Mesh Colors:
Coal Black (VU19), Desert Sand (VU11),
Quarry Grey (VU15), Sandy Beach (VU10),
Tidal Wave (VU16)



Novello (maximum 50)

6400
6401
6410
6411

Black Shell / Arm / Armcap only



Supra (maximum 50)

5330-4 5
5330L-4 5
5331-4 5
5331L-4 5



Synopsis (maximum 50)

5080-0	5080-3	5081-0
5081-3	5090-4	5091-4

Stack, Nesting + Guest



Sidero (maximum 50)

6900
6900C
6901
6901C
2125WS (chair dolly)



Sonic (maximum 100)

6508	6508-1	6508MB	6508MB-1	6509	6509-1	6509MB
6509MB-1	6511	6511-1	6513	6513-1	6513MB	6513MB-1
6514	6514-1	6514MB	6514MB-1	6515	6515-1	6517WS

5 Plastic Colors:
Night (BLK), Latte (LAB), Scarlet (SAR),
Cloud (IVC), Shadow (SHW)

Black Mesh on MB models



Spritz (maximum 50)

6764C
6765C

Black Mesh only



Roma Nester (maximum 50)

1890
1899

Black Mesh only

3 Frame Finishes:
Black (BLK), Chrome (CHM),
Tungsten (TUN)



Duet (maximum 100)

6620	6620-1	6621
6621-1	6621-2	6624

5 Plastic Colors:
Night (BLK), Latte (LAB), Scarlet (SAR),
Cloud (IVC), Shadow (SHW)



Popcorn (maximum 100)

6710	6710-1	6711
6710-2	6711-1	6715
6711-2	6716 Clear Glides (set of 2)	

5 Plastic Colors:
Night (BLK), Latte (LAB), Scarlet (SAR),
Cloud (IVC), Shadow (SHW)

Terms and Conditions

• All product series have MAXIMUM order quantities which can be fulfilled within the 2 Day Lightning program. These are noted next to each series. For greater quantities, please contact CustomerCare for lead times and terms.

- Orders must clearly state, "2 Day Lightning" at the time of submittal
- Program is limited to exact models within series listed above
- Program is limited to exact textile

patterns listed and exact colorways carded

- Orders cannot be changed or canceled after order acknowledgment
- Current Global list pricing applies at the time of order
- All eligible models are UPSable; Global reserves the right to ship "best way"
- Bakhita, Popcorn, Duet and Sonic models may be multiple packaged and shipped "best way"
- Orders must be clean with correct model numbers, options, textiles,

correct pricing, etc., to apply

- Dealer must be in good standing and within terms for order to be processed without delay
- Finished products will ship from our factories in as little as two business days.
- Program available in the 48 contiguous United States
- Orders to ship outside Global's distribution model; order shipment address can be to the dealer or end-user directly

- Standard model options listed under Optional Features section in the price list are available. Standard model options include aluminum bases, painted frame finishes, ballistic nylon backs, glide options and hard surface casters. Memory Foam as a standard option is not available (standard lead-times apply).

work
space +
meeting
areas



Bakhita 6780 (page 83) Round Table shown in Milk (MLK) with Bakhita 6751 (page 39) Side Chair shown in Milk (MLK).

All seating is nationally stocked and available immediately or part of the 2DAY LIGHTNING program and ships within two business days.

Zira

Zira offers hundreds of mix and match components to meet any design specification. Components can be freestanding for single workstation configurations, or brought together to form multiple work groups.



Silver bar handles (HQ) come standard on our stocked product. Locks and hardware feature a matching silver finish.

Available immediately in the following finish:



ACJ Absolute Acajou



HQ Handle

1" thick (A3) worksurfaces feature Global's preferred edging in a matching color.

Run-off surfaces feature a silver metal leg with 1/2" adjustable glides.



Zira Layout Shown

Absolute Acajou (ACJ)

Model	Description	List Price
Z2472T	24" Deep Freestanding Table	\$695
Z16L2BFS+HQ	Box, Box, File Storage Shell	\$702
Z72S42H+HQ	Open Hutch with Closed Back	\$1282
ZHBC72	Bookcase	\$863
PH3T6601	Height Adjustable Table Base	\$973
PHAT2970T	Height Adjustable Table Top	\$429
Total		\$4944

Components Shown

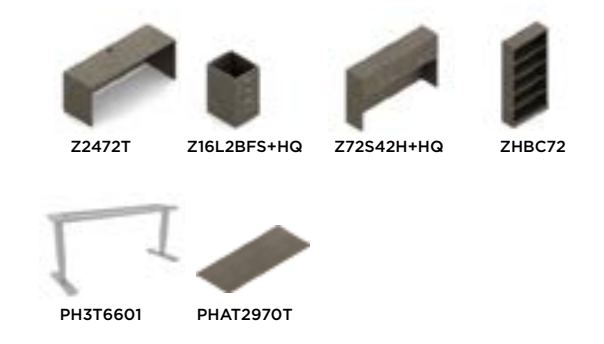

Seating shown Factor 5540-8 with Shadow Frame (SH) (page 6)

Available immediately in the following finish:

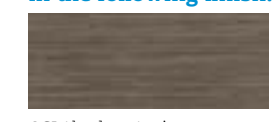

ACJ Absolute Acajou

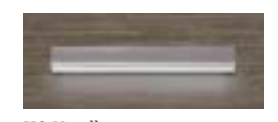

HQ Handle



Zira Layout Shown

Absolute Acajou (ACJ)

Model	Description	List Price
Z2472T	24" Deep Freestanding Table	\$695
Z16L2ES+HQ	File, File Storage Shell	\$609
Z16L2BFS+HQ	Box, Box, File Storage Shell	\$702
Z72S42H+HQ	Open Hutch with Closed Back	\$1282
Z3072F23+HQ	Double Pedestal Desk	\$1882
Z36L2E	File, File Storage Module (\$1357 each)	\$2714
	Total	\$7884

Components Shown



Seating shown Factor 5541-8 with Cloud Frame (IC) (page 6)

Available immediately in the following finish:

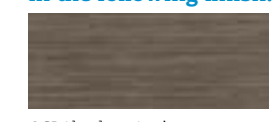

ACJ Absolute Acajou

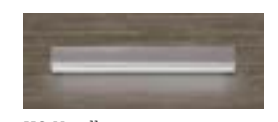

HQ Handle

Zira INstock components



Z3072F23+HQ
Double Pedestal Desk
72w x 30d x 29h
\$1921



Z3072F3L+HQ
Single Pedestal Desk - LEFT
72w x 30d x 29h
\$1440



Z3072F3R+HQ
Single Pedestal Desk - RIGHT
72w x 30d x 29h
\$1440



Z2448ER
Flush Return - RIGHT
24w x 48d x 29h
\$539



Z2448EL
Flush Return - LEFT
24w x 48d x 29h
\$539



Z2448FB
Flush Bridge
24w x 48d x 29h
\$471



Z2472T
24" Deep Freestanding Table
72w x 24d x 29h
\$695



Z3060MRR
Return w/Metal Leg - RIGHT
60w x 30d x 29h
\$694



Z36L2ES+HQ
File, File Storage Shell
36w x 23.4d x 28.5h
\$1105



Z16L2ES+HQ
File, File Storage Shell
16w x 23.4d x 28.5h
\$609



Z16L2BFS+HQ
Box, Box, File Storage Shell
16w x 23.4d x 28.5h
\$702



Z36L2E+HQ
File, File Storage Module
36w x 24d x 30h
\$1357



ZHBC72
Bookcase
36w x 12d x 72.4h
\$863



Z72S42H+HQ
Open Hutch with Closed Back
72w x 15d x 42.4h
\$1282

Available immediately in the following finish:



ACJ Absolute Acajou



HQ Handle

Foli Height Adjustable Tables (page 83).

PH3T6601
Height Adjustable Table Base
\$973

PH3TLK6601
3rd Leg Kit
\$667

PHAT2970T
Table Top
\$429

PHAT2958T
Table Top
\$391

PHAT2346T
Table Top
\$314

Zira Sample Layouts

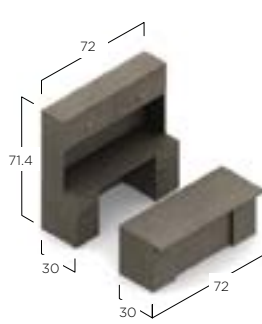

LAYOUT ZIRA EXEC1
Z3072F23+HQ Z2472T
Z16L2ES+HQ Z16L2BFS+HQ
Z72S42H+HQ ZHBC72 (2)
\$5209

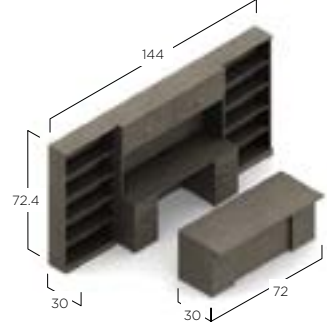

LAYOUT ZIRA EXEC2
Z3072F23+HQ Z2472T
Z16L2ES+HQ Z16L2BFS+HQ
Z72S42H+HQ ZHBC72 (2)
\$6935

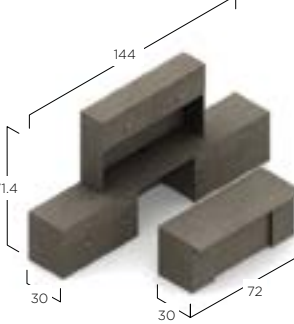

LAYOUT ZIRA EXEC3
Z3072F23+HQ Z2472T
Z16L2ES+HQ (2) Z16L2BFS+HQ
Z72S42H+HQ Z36L2ES
\$7884

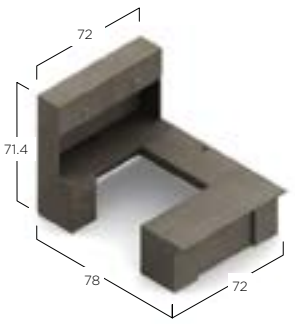

LAYOUT ZIRA EXEC4
Z3072F3R+HQ Z2448FB
Z16L2ES+HQ Z2472T
Z72S42H+HQ
\$4497

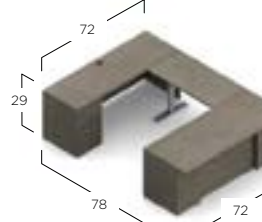

LAYOUT ZIRA EXEC5*
Z3072F3R+HQ PHAT2346T
PH3T6601 Z16L2ES+HQ
Z2472T
\$4031

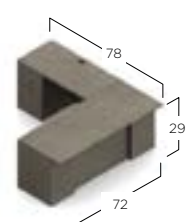

LAYOUT ZIRA MANAGER1
Z3072F3R+HQ Z16L2ES+HQ
Z2448EL
\$2558

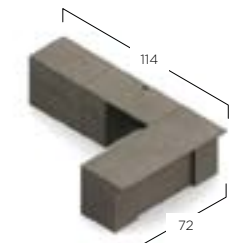

LAYOUT ZIRA MANAGER2
Z3072F3R+HQ Z16L2ES+HQ
Z2448EL Z36L2E+HQ
\$3945

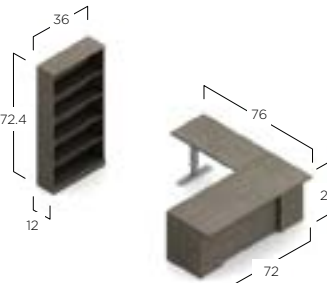

LAYOUT ZIRA MANAGER3*
Z3072F3R+HQ PHAT2346T
PH3T6601 Z16L2ES+HQ
ZHBC72
\$5062

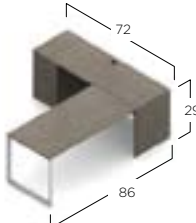

LAYOUT ZIRA MANAGER4A
Z2472T Z16L2BFS+HQ
Z3060MRR
\$2091

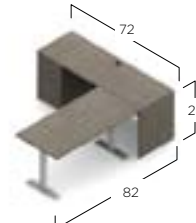

LAYOUT ZIRA MANAGER4B*
Z2472T Z16L2BFS+HQ
PHAT2958T PH3T6601
\$2761

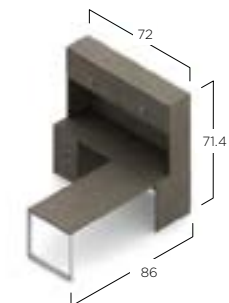

LAYOUT ZIRA MANAGER5A
Z2472T Z16L2BFS+HQ
Z3060MRR Z72S42H+HQ
\$3373

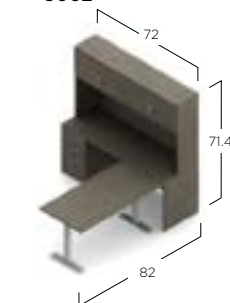

LAYOUT ZIRA MANAGER5B*
Z2472T Z16L2BFS+HQ
PHAT2958T PH3T6601
Z72S42H+HQ
\$4043

*Shown with Foli Height Adjustable Tables (page 83).

Genoa

Work with ease and privacy, even in high traffic office environments. Genoa's extended corner island offers users an ergonomically correct Executive suite with ample area for computers of various sizes and shapes, in addition to everyday work materials, while providing an oversized worksurface for conferencing.



1" thick worksurfaces feature self-edging in a matching color.

Lateral files include black pulls and hardware.

File drawers accommodate letter and legal files with standard locks on all pedestals.

Available immediately in the following finish:



ACJ Absolute Acajou



Genoa Layout Shown

Absolute Acajou (ACJ)

Model	Description	List Price
G3672DP	Double Pedestal Desk	\$1034
G2036LF	2 Drawer Lateral File (\$876 each)	\$1752
Total		\$2786

Components Shown



Seating shown G1 Ergo Select 7332 (page 14)

Available immediately
in the following finish:

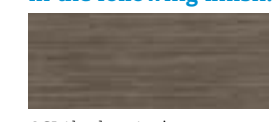

ACJ Absolute Acajou



Available immediately in the following finish:



ACJ Absolute Acajou



Seating shown Goal 2239-6 (page 22)

Genoa Layout Shown

Absolute Acajou (ACJ)

Model	Description	List Price
G3060SPR	Single Pedestal Desk - RIGHT (\$725 each)	\$1450
G2040FL	Flush Return - LEFT (\$598 each)	\$1196
G3060SPL	Single Pedestal Desk - LEFT (\$725 each)	\$1450
G2040FR	Flush Return - RIGHT (\$598 each)	\$1196
Total		\$5292

Components Shown

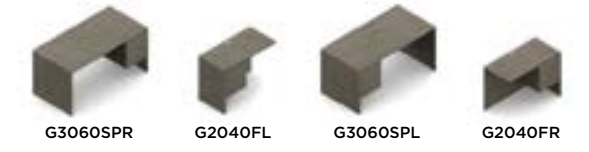

Genoa INstock components



G3672DP
Double Pedestal Desk
72w x 36d x 29h
\$1034



GHBC72
Bookcase
36w x 12d x 72h
\$919



G3060DP
Double Pedestal Desk
60w x 30d x 29h
\$820



G2040FL
Flush Return - LEFT
40w x 20d x 29h
\$598



G2040FR
Flush Return - RIGHT
40w x 20d x 29h
\$598



G2445SPR
Single Pedestal Desk - RIGHT
45w x 24d x 29h
\$566



G3060SPL
Single Pedestal Desk - LEFT
60w x 30d x 29h
\$725



G3060SPR
Single Pedestal Desk - RIGHT
60w x 30d x 29h
\$725



G2036LF
2 Drawer Lateral Files
36w x 20d x 29h
\$876



G2066CK
Kneespace Credenza
66w x 20d x 29h
\$978

Available immediately in the following finish:



ACJ Absolute Acajou

Genoa Sample Layouts

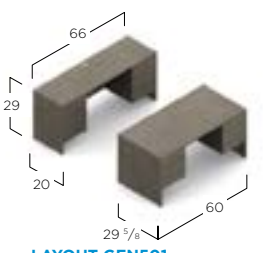

LAYOUT GEN501
G3060DP G2066CK
\$1798

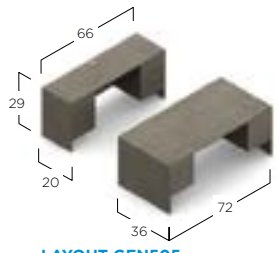

LAYOUT GEN505
G3672DP G2066CK
\$2012

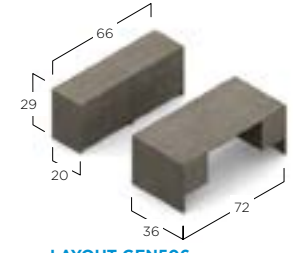

LAYOUT GEN506
G3672DP G2036LF (2)
\$2786

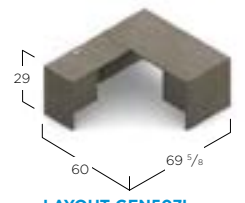

LAYOUT GEN507L
G3060SPR G2040FL
\$1323

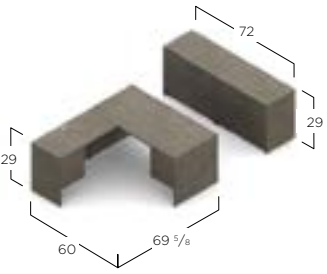

LAYOUT GEN507L
G3060SPR G2036LF (2)
\$3075



G3060SPR single pedestal desk - RIGHT shown with Roma seating (page 19).

Intelli Beam™ with Foli Height Adjustable Tables

Intelli Beam brings forward a new era of open plan environments.

18 x 60 Starter Extension Kit

Starter fabric extension kits include a tackable fabric panel and appropriate hardware to "stack-on" to existing starter kits (IBBSU2460S). The extension kit adds to the height of the beam, providing a greater sense of privacy, space division and some sounds absorption.



Intelli Beam includes two knockouts for duplexes and one knockout for data.

The basefeed powers 4-circuits in a 2+2 electrical configuration (2 utility circuits and 2 dedicated circuits). This must be specified with an IBBSU2460S - this will then power the starter kit and any add-on kit connected to it. The base feed must be hardwired to the building power supply by a licensed electrician.

T-leg with adjustable glides

24 x 60 Starter Beam Kit

The starter kit includes everything you need to create a 2-person workstation (acts as a freestanding piece), or to start a run of more workstations. Just specify duplexes and a basefeed separately to get up and running.



List price as shown \$4014



List price as shown \$4578

18 x 60 Add-On Extension Kit

Add-on fabric extension kits include a tackable fabric panel and appropriate hardware to "stack-on" to existing add-on kits (IBBAT2460S). The extension kit adds to the height of the beam, providing a greater sense of privacy, space division and some sounds absorption.



24 x 60 Add-On Beam Kit

Add-on kits includes all the pieces required to expand upon the starter kit. Add one additional add-on kit for a 4-pack, two add-on kits for a 6-pack or three for an 8-pack. Add-on kits must be used with one starter kit. Specify duplexes separately.



List price as shown \$8710

INstock components



IBBSU2460S
24 x 60 Starter Beam Kit
Includes Intelli Beam raceway, vertical base feed cover, power distribution housing, 17" electrical jumper cable and (2) end of run trims.
List Price **\$1082**



IBBAT2460S
24 x 60 Add-On Beam Kit
Includes Intelli Beam raceway, power distribution housing and 17" electrical jumper cable.
List Price **\$757**



IBSFE1860S
18 x 60 Starter Extension Kit
Fabric starter extension kit attaches on top of a starter beam kit of the same width. Must be used in conjunction with starter beam kits.
List Price **\$564**



IBAFE1860S
18 x 60 Add-On Extension Kit
Fabric add-on extension kit attaches on top of an add-on beam kit of the same width. Must be used in conjunction with add-on beam kits.
List Price **\$443**



IBE8RDK1A
Base Feed
A pack of four duplexes (two Circuit 1 duplexes and two Circuit A duplexes). One pack will provide duplexes for one starter beam kit OR one add-on beam kit. Duplexes snap into the power distribution housing within the Intelli Beam raceway.
List Price **\$128**



IBE8FR3PBS
Base Feed
Provides single power entry from floor or wall located building power supply. Must be hardwired to the building power supply by a licensed electrician.
List Price **\$420**

IBE8RDK2B

A pack of four duplexes (two Circuit 2 duplexes and two Circuit B duplexes). One pack will provide duplexes for one starter beam kit OR one add-on beam kit. Duplexes snap into the power distribution housing within the Intelli Beam raceway.
List Price **\$128**

Available immediately in the following textile + finish:

Tackboard - Anchorage



AN64 Cloud

Frame Finish



TUN Tungsten

Swap Tables

It's a simple thing done right. The right proportions. Flawless surfaces. Perfect structure. Squares or rounds at the floor with a gentle float.



6 FOOT SEATED HEIGHT CONFERENCE TABLE PACKAGE
GRB22-TUN x 2 GRT6TP
***1763**



6 FOOT BAR HEIGHT CONFERENCE TABLE PACKAGE
GRB22H41-TUN x 2 GRT6TP
***1847**



8 FOOT SEATED HEIGHT CONFERENCE TABLE PACKAGE
GRB22-TUN x 2 GRT8TP
***1898**



8 FOOT BAR HEIGHT CONFERENCE TABLE PACKAGE
GRB22H41-TUN x 2 GRT8TP
***1982**



SEATED HEIGHT TABLE PACKAGE
GRB22-TUN GRBTP36 ***899**
BAR HEIGHT TABLE PACKAGE
GRB22H41-TUN GRBTP36 ***941**

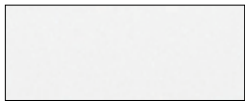

Available immediately in the following finishes:

ACJ Absolute Acajou

DWT White

Base Finish

TUN Tungsten

Swap Tables Components



GRT6TP
6' Rectangular Top
36d x 72w x 1h
***491**



GRT8TP
8' Rectangular Top
36d x 96w x 1h
***626**



GRBTP36
3' Round Table Top
36dia x 1h
***263**



GRB22 (TUN)
Seat Height Round Base
***636**



GRB22H41 (TUN)
Bar Height Round Base
***678**

Bakhita Tables

A stable four-legged base enables seating to tuck in effortlessly. Standard and bar height tables are offered in 28" round and square tops, in Milk with Silver bases.



Bakhita 6780
Round Table
List Price ***425**
Shown in Milk (MLK).



Bakhita 6781
Round Table, Bar Height
List Price ***435**
Shown in Milk (MLK).



Bakhita 6785
Square Table
List Price ***465**
Shown in Milk (MLK).



Bakhita 6786
Square Table, Bar Height
List Price ***475**
Shown in Milk (MLK).

For Bakhita seating see page 39..

Available immediately in the following plastic finish:



MLK Milk

Foli Height Adjustable Tables

Electric height adjustment allow users to move between sitting and standing.



HEIGHT ADJUSTABLE BASE



PHAT6601
Height Adjustable Table Base
***973**



PHATLK6601
3rd Leg Kit
***667**

HEIGHT ADJUSTABLE LAMINATE TABLE TOPS



PHAT2970T
Height Adjustable Table Top
***429**



PHAT2958T
Height Adjustable Table Top
***391**



PHAT2346T
Height Adjustable Table Top
***314**

Available immediately in the following finishes:



ACJ Absolute Acajou

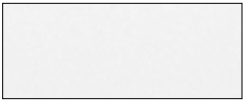

DWT White



Lite Lift II Table

Lite-Lift II is ideal for applications that require a lightweight and easy to clean folding table.



MVLFRT72
6' Rectangular Folding Table
\$284

Lite Lift II Table Features

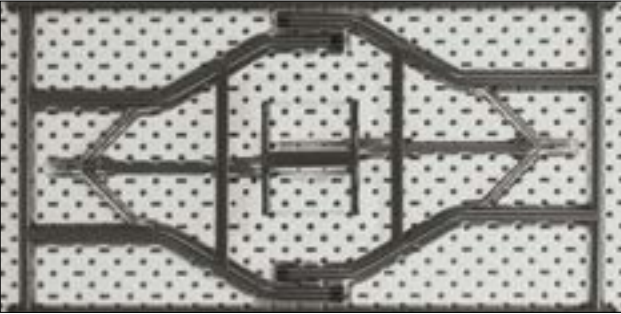

High strength 19 gauge, 1 1/8" diameter steel tubular legs have welded crossbars for durability and stability.



Folding Legs



Table tops are available in Oyster (OS) finish and aesthetically compliment all environments. UV inhibitors prevent fading.

Available immediately in the following finish:



Oyster Grey

Boardroom Tables

From small meeting rooms to large boardrooms, Global has meeting and conference tables to meet all your business needs.



GCT6RXTM
6' Rectangular Table with T-mold Edge and Slab Base
\$880



GCT8WRXTM
8' Rectangular Table with T-mold Edge and Slab Base
\$1133

Rectangular Table Features



Rectangle Top



T-mold Edge



Slab Base

Available immediately in the following finishes:



ACJ Absolute Acajou



DWT White



Seating shown Solar 8457 (page 29)

Zira (pages 64-71)



Z3072F23 + HQ
Double Pedestal Desk
72w x 30d x 29h
*1921



Z3072F3L + HQ
Single Pedestal Desk - LEFT
72w x 30d x 29h
*1440



Z3072F3R + HQ
Single Pedestal Desk - RIGHT
72w x 30d x 29h
*1440

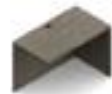

Z2448ER
Flush Return - RIGHT
24w x 48d x 29h
*539



Z2448EL
Flush Return - LEFT
24w x 48d x 29h
*539



Z2448FB
Flush Bridge
24w x 48d x 29h
*471



Z2472T
24" Deep Freestanding Table
72w x 24d x 29h
*695



Z3060MRR
Return w/Metal Leg - RIGHT
60w x 30d x 29h
*694



Z36L2ES + HQ
File, File Storage Shell
36w x 23.4d x 28.5h
*1105



Z16L2ES + HQ
File, File Storage Shell
16w x 23.4d x 28.5h
*609



Z16L2BFS+HQ
Box, Box, File Storage Shell
16w x 23.4d x 28.5h
*702



Z36L2E + HQ
File, File Storage Module
36w x 24d x 30h
*1357



ZHBC72
Bookcase
26w x 12d x 72.4h
*863



Z72S42H + HQ
Open Hutch with Closed Back
72w x 15d x 42.4h
*1282

Genoa (pages 72-79)



G3672DP
Double Pedestal Desk
72w x 36d x 29h
*1034



GHBC72
Bookcase
36w x 12d x 72h
*919



G3060DP
Double Pedestal Desk
60w x 30d x 29h
*820



G2040FL
Flush Return - LEFT
40w x 20d x 29h
*598



G2040FR
Flush Return - RIGHT
40w x 20d x 29h
*598



G2445SPR
Single Pedestal Desk - RIGHT
45w x 24d x 29h
*566



G3060SPL
Single Pedestal Desk - LEFT
60w x 30d x 29h
*725



G3060SPR
Single Pedestal Desk - RIGHT
60w x 30d x 29h
*725



G2036LF
2 Drawer Lateral Files
36w x 20d x 29h
*876



G2066CK
Kneespace Credenza
66w x 20d x 29h
*978

Swap Tables (page 82)



GRT6TP
6' Rectangular Top
36d x 72w x 1h
*491



GRT8TP
8' Rectangular Top
36d x 96w x 1h
*626



GRBTP36
3' Round Table Top
36dia x 1h
*263



GRB22 (TUN)
Seat Height Round Base
*636



GRB22H41 (TUN)
Bar Height Round Base
*678

Bakhita Tables (page 83)



6780
Round Table
28.5d x 28.5w x 29.5h
*425



6781
Round Table, Bar Height
28.5d x 28.5w x 40h
*435



6785
Square Table
28.5d x 28.5w x 29.5h
*465



6786
Square Table, Bar Height
28.5d x 28.5w x 40h
*475

Foli Height Adjustable Tables (page 83)



PH3T6601
Height Adjustable Table Base
10w x 26.8h
*973



PH3TLK6601
3rd Leg Kit
10d x 26.8h
*667



PHAT2970T
Height Adjustable Table Top
70w x 29d x 1h
*429



PHAT2958T
Height Adjustable Table Top
58w x 29d x 1h
*391



PHAT2346T
Height Adjustable Table Top
46w x 23d x 1h
*314

Boardroom Tables (pages 84-85)



GCT6RXTM
6' Rectangular Table with T-mold Edge and Slab Base
36d x 72w x 29h
*880



GCT8WRXTM
8' Rectangular Table with T-mold Edge and Slab Base
48d x 96w x 29h
*1133



FRT72B
6' Rectangular Folding with 30d x 72w x 29.25h
*284

filing + storage



1900P Filing 1936P-2F12 (page 90) 2 Drawer Lateral File, 1936P-4F12 (page 90) 4 Drawer Lateral File and 1936P-5F12 (page 90) 5 Drawer Lateral File shown in Designer White (DWT) finish.

Filing + Storage

Global provides a variety of innovative and cost effective "Storage Solutions" that can react to your daily demands.



- 9336P-2F1H**
36" Wide 2 Drawer Lateral File
36w x 18d x 27.125h
Shown in Designer White (DWT).
\$655
- 9336P-3F1H**
36" Wide 3 Drawer Lateral File
36w x 18d x 40.5h
Shown in Designer White (DWT).
\$870
- 9336P-4F1H**
36" Wide 4 Drawer Lateral File
36w x 18d x 54h
Shown in Designer White (DWT).
\$1092
- 9336P-5F1H**
36" Wide 5 Drawer Lateral File
36w x 18d x 65.25h
Shown in Designer White (DWT).
\$1376
- 9342P-2F1H (not shown)**
42" Wide 2 Drawer Lateral File
42w x 18d x 27.125h
\$739
- 9342P-3F1H (not shown)**
42" Wide 3 Drawer Lateral File
42w x 18d x 40.5h
\$964
- 9342P-4F1H (not shown)**
42" Wide 4 Drawer Lateral File
42w x 18d x 54h
\$1246
- 9342P-5F1H (not shown)**
42" Wide 5 Drawer Lateral File
42w x 18d x 65.25h
\$1551



- 1936P-2F12**
2 Drawer Lateral File
36w x 19.25d x 27.14h
Shown in Designer White (DWT).
\$644
- 1936P-4F12**
4 Drawer Lateral File
36w x 19.25d x 51.89h
Shown in Designer White (DWT).
\$1023
- 1936P-5F12**
5 Drawer Lateral File
36w x 19.25d x 66.39h
Shown in Designer White (DWT).
\$1212

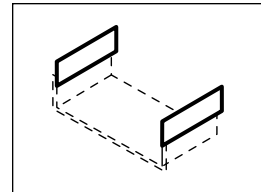

EDPS
Side Adapters
\$34

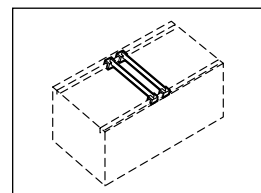

FBB
Front-to-Back Hanging File Bars
\$18

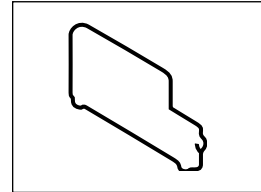

PD
Plate Dividers
\$27

Available immediately in the following finishes:



BLK Black **DWT** Designer White **LGR** Light Grey



- 25-201**
25"D 2 Drawer Vertical File with lock - Letter
15.15w x 25d x 29h
Shown in Designer White (DWT).
\$298
- 25-401**
25"D 4 Drawer Vertical File with lock - Letter
15.15w x 25d x 52h
Shown in Designer White (DWT).
\$394
- 25-501**
25"D 5 Drawer Vertical File with lock - Letter
15.15w x 25d x 64.25h
Shown in Designer White (DWT).
\$573
- 25-251 (not shown)**
25"D 2 Drawer Vertical File with lock - Legal
18.15w x 25d x 29h
\$346
- 25-451 (not shown)**
25"D 4 Drawer Vertical File with lock - Legal
18.15w x 25d x 52h
\$450
- 9336-S72L**
Storage Cabinet
36w x 18d x 72h
Shown in Designer White (DWT).
\$559
- 9336P-S72L**
Storage Cabinet (Looped Full Pull)
36w x 18d x 72h
Shown in Designer White (DWT).
\$559



- 19FP23BBF**
Box/Box/File Pedestal
15w x 22.625d x 27.625h
Shown in Designer White (DWT).
\$358
- 19FP23FF**
File/File Pedestal
15w x 22.625d x 27.625h
Shown in Designer White (DWT).
\$358

Available immediately in the following finishes:



BLK Black **DWT** Designer White **LGR** Light Grey



File Buddy 1105
Pneumatic Swivel Stool
Dimensions: 14dia x 16.25h - 21.25h
Shown in Allante FRee, Ink (A16F).
\$326

Available immediately in the following textile:

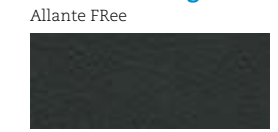

A16F Ink

OfficestoGo

OfficestoGo.com

Office Furniture

at Exactly the Right Price.



OfficestoGo Work + Task Seating



OTG11685B (pictured left) - page 103



OTG2913 page 96



OTG11710 page 96



OTG2803 page 99



OTG3191 page 100



OTG11920B page 113



OTG11653 page 104

OTG11685B (page 103) shown in Carrera Zest (CE84) and Superior Laminate Desking shown in Autumn Walnut (AWL) finish.



OTG2913
Luxhide Multi-Function List Price **\$740**



OTG11710
Multi-Function List Price **\$660**



OTG3101
Mesh Back Synchro-Tilter List Price **\$660**



OTG3103
Mesh Back Multi-Function List Price **\$695**



Key Features



Back height adjustment via internal ratchet

Available immediately in the following textile:



BL20 Black



Multi-Function mechanism with seat depth adjustment



See pages 172-175 for more information.



Key Features



Back height adjustment via internal ratchet

Available immediately in the following textile:



QL10 Black



Width and height adjustable arms



See pages 172-175 for more information.



Key Features



Height and depth adjustable lumbar support

Available immediately in the following textile:



BL20 Black



Multiple position tilt lock



See pages 172-175 for more information.



Key Features



Height and depth adjustable lumbar support

Available immediately in the following textile:



Black Mesh fabric seat



Multi-Function mechanism with seat depth adjustment



See pages 172-175 for more information.



OTG2801 (pictured left)
Mesh Synchro-Tilter with upholstered seat List Price **\$590**



OTG2803
Mesh Multi-Function with upholstered seat List Price **\$615**



OTG2821
Mesh Synchro-Tilter with mesh seat List Price **\$740**



Key Features



Multi-Function mechanism



Height adjustable lumbar support

Available immediately
in the following textile:
Mesh



Black Mesh fabric seat
(OTG2801)



See pages 172-175 for more information.

For specifications and dimensions see page 158.



Available immediately
in the following textile:
Mesh



Black Mesh fabric seat



See pages 172-175 for more information.

For specifications and dimensions see page 158.



OTG11325B
Mesh Back Synchro-Tilter
List Price **\$570**



Key Features



Multiple adjustment arm



Sliding seat mechanism

Available only in the following textile:
Quilt



QL10 Black



For specifications and dimensions see page 158.



OTG3191
Mesh Back Synchro-Tilter
List Price **\$540**



Key Features



Back height adjustment via internal ratchet



Height and width adjustable arms

Available immediately in the following textile:
Luxhide



BL20 Black

2DAY SHIP MORE TEXTILES logo

See pages 172-175 for more information.

For specifications and dimensions see page 158.



OTG11692
Mesh Back Tilter
List Price **\$450**



Key Feature



Seat depth adjustment

Available immediately in the following textile:
Luxhide



BL20 Black

2DAY SHIP MORE TEXTILES logo

See pages 172-175 for more information.

For specifications and dimensions see page 157.



OTG11980B
Mesh Back Synchro-Tilter
List Price **\$515**



Key Feature



Height adjustable arms with polyurethane armrests

Available immediately in the following textile:
Quilt



QL10 Black

2DAY SHIP MORE TEXTILES logo

See pages 172-175 for more information.

For specifications and dimensions see page 158.



OTG11685B
Mesh High Back Synchro-Tilter

List Price **\$490**



OTG11686B
Mesh Mid Back Synchro-Tilter

List Price **\$435**

Available immediately
in the following textile:



Black Mesh fabric seat



2DAY SHIP
MORE TEXTILES

See pages 172-175 for more information.



For specifications and dimensions see pages 157-158.



OTG11653
Multi-Function List Price **\$565**



Key Features



Pivot arm rest



Manual back height adjustment

Available immediately in the following textile:



QL10 Black

2DAY SHIP MORE TEXTILES logo

See pages 172-175 for more information.

For specifications and dimensions see page 161.



OTG12110B
Mesh Back Luxhide Tilter List Price **\$440**



Key Feature



Lumbar pad with flexible support

Available only in the following textile:



BL20 Black



For specifications and dimensions see page 157.



OTG11652
High Back Tilter List Price **\$355**



Key Features



Depth adjustable lumbar support



Height adjustable arms

Available immediately in the following textile:



QL10 Black

2DAY SHIP MORE TEXTILES logo

See pages 172-175 for more information.

For specifications and dimensions see page 160.



OTG11651
Low Back Tilter List Price **\$330**



Key Features



Depth adjustable lumbar support



Height adjustable arms

Available immediately in the following textile:



QL10 Black

2DAY SHIP MORE TEXTILES logo

See pages 172-175 for more information.

For specifications and dimensions see page 160.



OTG11641B
Mesh High Back Synchro-Tilter
List Price **\$410**



OTG11647B
Mesh Mid Back Synchro-Tilter
List Price **\$370**



OTG11642B
Mesh Back Task
Armless
List Price **\$260**



OTG11642B
Mesh Back Task with
Adjustable Height Arm Kit
(OTG11620)
List Price **\$350**



OTG11642B
Mesh Back Task with Drafting
Stool Kit (OTG11600)
List Price **\$470**



OTG11642B
Mesh Back Task with Drafting
Stool Kit (OTG11600) and
Adjustable Height Arm Kit
(OTG11620)
List Price **\$560**

Available only in the following textile:



Black Mesh fabric seat



OTG11620
Adjustable Height Arm Kit
List Price **\$90**



OTG11600
Drafting Stool Kit
List Price **\$210**



For specifications and dimensions see pages 156-157, 171.



OTG11516B
Mesh High Back Synchro-Tilter
List Price **\$455**



OTG11514B
Mesh Mid Back Tilter
List Price **\$325**



OTG11865B
Mesh Back Tilter
List Price **\$460**



OTG12112B
Mesh Back Tilter
List Price **\$365**



OTG11769B
Mesh Back Multi-Function
List Price **\$550**



OTG11769B Key Features



Styled back design



Width and height adjustable arms



Seat sliding mechanism



Back height adjustment via internal ratchet



Multi-Tilter mechanism

Available only in the following textile:



Black Mesh fabric seat

For specifications and dimensions see pages 156-158.



Key Features



Stylish wing back design



Height adjustable arms with titanium accents

Available only in the following textile:



QL10 Black

For specifications and dimensions see page 157.



Key Features



Stylish back design



Height adjustable arms

Available only in the following textile:



BL20 Black

For specifications and dimensions see page 156.



OTG11950B
Multi-Function List Price **\$440**



Key Features



Back height adjustment via internal ratchet



Seat depth adjustment

Available only in the following textile:

Quilt



QL10 Black



For specifications and dimensions see page 161.



OTG10904B
Mesh Back Synchro-Tilter List Price **\$450**



Key Features



Polished aluminum base



Synchro-tilt mechanism with multiple position locks

Available only in the following textile:

Mesh



Black Mesh fabric seat



For specifications and dimensions see page 157.



OTG11631B
Multi-Function List Price **\$420**



Key Features



Height adjustable lumbar support



Seat and back angle adjustments

Available only in the following textile:

Quilt



QL10 Black



For specifications and dimensions see page 160.



OTG11328B
Mesh Back Tilter List Price **\$415**



Key Features



Fixed arms



Sliding seat mechanism

Available only in the following textile:

Quilt



QL10 Black



For specifications and dimensions see page 157.



OTG11920B
Mesh High Back Tilter
List Price **\$390**



OTG11921B
Mesh Mid Back Tilter
List Price **\$340**



OTG11922B
Mesh Mid Back Task - Armless
List Price **\$285**



OTG11923B
Mesh Back Guest - Armless
List Price **\$285**



OTG11600
Drafting Stool Kit
List Price **\$210**

OTG11924
Adjustable Height Arm Kit
for use on OTG11922B and OTG11923B
List Price **\$80**



Available only in the following textile:

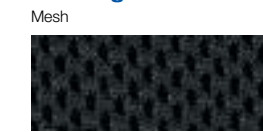

Black Mesh fabric seat



For specifications and dimensions see pages 156, 166.



OTG11715B
Synchro-Tilter
List Price **\$390**



Key Feature



Decorative outer back shell

Available only in the following textile:



Black Mesh fabric seat and back



For specifications and dimensions see page 160.



OTG11320B
Mesh Back Tilter
List Price **\$350**



Key Feature



Decorative outer back shroud

Available only in the following textile:



Black Mesh fabric seat



For specifications and dimensions see page 156.



OTG11850B
Tilter
List Price **\$345**



Available only in the following textile:



QL10 Black



For specifications and dimensions see page 160.



OTG11612B
Tilter
List Price **\$325**



Available only in the following textile:



QL10 Black



For specifications and dimensions see page 160.



OTG11642B
Mesh Back Task - Armless
List Price **\$260**



OTG11922B
Mesh Back Task - Armless
List Price **\$285**



OTG11343B
Air Mesh Task
List Price **\$210**



OTG11650
Task - Armless
List Price **\$255**



OTG11620
Adjustable Height Arm Kit
List Price **\$90**

OTG11600
Drafting Stool Kit with 10" Gas Cylinder
List Price **\$210** (kit only)
List Price **\$260** (chair only)
Total As Shown **\$470**



OTG11924
Adjustable Height Arm Kit
List Price **\$80**

OTG11600
Drafting Stool Kit with 10" Gas Cylinder
List Price **\$210** (kit only)
List Price **\$285** (chair only)
Total As Shown **\$495**



OTG11620
Adjustable Height Arm Kit
List Price **\$90**

OTG11600
Drafting Stool Kit with 10" Gas Cylinder
List Price **\$210** (kit only)
List Price **\$210** (chair only)
Total As Shown **\$420**



OTG11620
Adjustable Height Arm Kit
List Price **\$90**

OTG11600
Drafting Stool Kit with 10" Gas Cylinder
List Price **\$210** (kit only)
List Price **\$255** (chair only)
Total As Shown **\$465**

Available only in the following textile:



Black Mesh fabric seat



For specifications and dimensions see page 156.

Available only in the following textile:



Black Mesh fabric seat



For specifications and dimensions see page 156.

Available only in the following textile:



Black Mesh fabric seat and back



For specifications and dimensions see page 160.

Available immediately in the following textile:



QL10 Black



See pages 172-175 for more information.

For specifications and dimensions see page 160.



OfficestoGo Conference + Management Seating



OTG11730B (pictured left) - page 125



OTG11648B page 120



OTG2700 page 123



OTG11786B page 129



OTG13026B page 135



OTG11657B page 127



OTG10902B page 133

OTG11730B (page 125) shown in Fusion Cobalt (FU83) and Superior Laminate Desking shown in Autumn Walnut (AWL) finish.



OTG11648B
Segmented Cushion Tilter List Price **\$575**



Key Features



Padded armrests can be removed to achieve a sleek look

Available only in the following textile:

Luxhide



BL20 Black



For specifications and dimensions see page 164.



OTG11858B
Segmented Cushion Tilter List Price **\$480**



Key Features



Padded armrests



Segmented cushion back

Available only in the following textile:

Luxhide



BL20 Black



For specifications and dimensions see page 163.



OTG11300B
Tilter with Wood Arms and Base List Price **\$550**



Key Feature



Decorative wood arms and base

Available only in the following textile:

Luxhide



BL20 Black



For specifications and dimensions see page 164.



OTG11618B
Tilter List Price **\$485**



Key Feature



Integrated headrest

Available only in the following textile:

Luxhide



BL20 Black



For specifications and dimensions see page 163.



OTG2700 (page 123) shown in Waterfall Imagine (WA44) with Superior Laminate Desking shown in Artisan Grey (AGL) finish.



OTG2700
High Back Tilter

List Price **\$525**



OTG2700 Side View



OTG2701
Mid Back Tilter

List Price **\$505**



OTG2782
Guest Chair

List Price **\$400**

Available immediately
in the following textile:

Luxhide



BL20 Black



**2DAY
SHIP** MORE
TEXTILES

See pages 172-175 for more information.



For specifications and dimensions see pages 164, 167.



OTG11730B
High Back Tilter

List Price **\$520**



OTG11732
High Back Tilter - Armless

NOW STOCKED

List Price **\$520**



OTG11734B
Mid Back Tilter

List Price **\$485**



OTG11735
Mid Back Tilter - Armless

NOW STOCKED

List Price **\$485**

Available immediately
in the following textiles:

Luxhide



BL20 Black

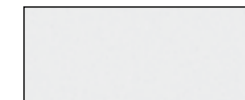

BL28 White (OTG11730B only)



2 DAY SHIP
MORE TEXTILES

See pages 172-175 for more information



For specifications and dimensions see pages 163-164.



OTG2788
Tilter
List Price **\$465**



Available immediately in the following textile:
Luxhide



BL20 Black



See pages 172-175 for more information.

For specifications and dimensions see page 163.



OTG11790B
Mesh Back Knee-Tilter
List Price **\$505**



Key Features



Knee-tilt mechanism



Multiple position tilt lock

Available only in the following textile:
Mesh



Black Mesh fabric seat

For specifications and dimensions see page 162.



OTG11657B
Mesh Back Tilter
List Price **\$420**



OTG11657B Side View

Available only in the following textile:
Mesh



Black Mesh fabric seat



For specifications and dimensions see page 162.

OTG11657B Mesh Back Tilter shown with SL9544RS Racetrack Boardroom Table in Artisan Grey Laminate AGL finish (page 198).

Key Features



Polished aluminum arm with removable arm pad



Chrome steel base





OTG11786B
Tilter

List Price **\$515**



Key Feature



Chrome steel base

**Available immediately
in the following textile:**
Luxhide



BL20 Black



**2DAY
SHIP** MORE
TEXTILES

See pages 172-175 for more information.



For specifications and dimensions see page 164.



OTG11975B
Tilter

List Price **\$380**



Key Feature



Padded armrests

Available only in the following textile:

Luxhide



BL20 Black



For specifications and dimensions see page 163.



OTG11617B
Tilter

List Price **\$370**



Key Features



Padded armrests

Available only in the following textile:

Luxhide



BL20 Black



For specifications and dimensions see page 163.



OTG11782B
Tilter

List Price **\$335**



Key Feature



Molded arm with upholstered inset cap

Available only in the following textile:

Luxhide



BL20 Black



For specifications and dimensions see page 163.



OTG11776B
Tilter

List Price **\$265**



Key Feature



Stylish Polyurethane armrests

Available only in the following textile:

Luxhide



BL20 Black



For specifications and dimensions see page 163.



OTG11750B
Mesh Back Tilter List Price **\$335**



Key Feature



Stylish mesh back pattern

Available only in the following textile:

Mesh



Black Mesh fabric seat



For specifications and dimensions see page 162.



OTG10901B
Mesh Back Tilter List Price **\$250**



Key Feature



Stylish chrome accent on outer back

Available only in the following textile:

Mesh



Black Mesh fabric seat



For specifications and dimensions see page 162.



OTG10902B
Mesh Back Tilter List Price **\$250**



Key Feature

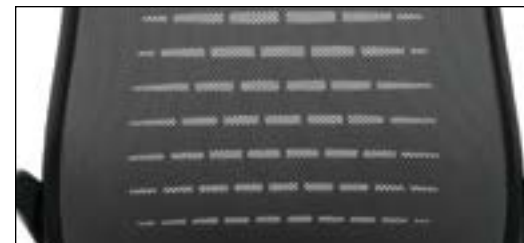

Stylish mesh back pattern

Available only in the following textiles:

Mesh



Grey Mesh back



Black Mesh fabric seat



For specifications and dimensions see page 162.



OTG10900B
Mesh Back Tilter List Price **\$225**



Key Feature



Stylish Polyurethane molded armrests

Available only in the following textiles:

Mesh



Grey Mesh back



Black Mesh fabric seat



For specifications and dimensions see page 162.



OTG13026B
Mesh Low Back Tilter

List Price **\$330**



OTG13026B Side View



OTG13050B (Shown with Casters - included)
Mesh Armchair

List Price **\$330**



OTG13050B (Shown with Glides - included)
Mesh Armchair

List Price **\$330**



OTG13050BT (Shown on OTG13050B)
Tablet only

List Price **\$100**

Available only in the following textile:

Luxhide



BL20 Black



For specifications and dimensions see pages 163, 166.



OTG11600
Drafting Stool Kit with 10" Gas Cylinder
List Price **\$210** (stool kit only)
List Price **\$260** (chair only - OTG11642B)
Total As Shown **\$470**



OTG11600
Drafting Stool Kit with 10" Gas Cylinder
List Price **\$210** (stool kit only)
List Price **\$285** (chair only - OTG11922B)
Total As Shown **\$495**



OTG11600
Drafting Stool Kit with 10" Gas Cylinder
List Price **\$210** (stool kit only)
List Price **\$210** (chair only - OTG11343B)
Total As Shown **\$420**



OTG11600
Drafting Stool Kit with 10" Gas Cylinder
List Price **\$210** (stool kit only)
List Price **\$255** (chair only - OTG11650B)
Total As Shown **\$465**

OTG11620
Adjustable Height Arm Kit
List Price **\$90**



Available only in the following textile:



Black Mesh fabric seat



For specifications and dimensions see page 171.

OTG11924
Adjustable Height Arm Kit
List Price **\$80**



Available only in the following textile:



Black Mesh fabric seat



For specifications and dimensions see page 171.

OTG11620
Adjustable Height Arm Kit
List Price **\$90**



Available only in the following textile:



Black Mesh fabric seat and back



For specifications and dimensions see page 171.

OTG11620
Adjustable Height Arm Kit
List Price **\$90**



Available immediately in the following textile:



QL10 Black seat and back



See pages 172-175 for more information.

For specifications and dimensions see page 171.



Model	Description	List Price
OTG5001NA	Armless Single Seat (\$580 each)	\$1160
OTG5002	Single Arm - Reversible (\$165 each)	\$330
OTG5003	Cushion Bridge	\$225
Total		\$1715



Model	Description	List Price
OTG5001NA	Armless Single Seat (\$580 each)	\$1160
OTG5002	Single Arm - Reversible	\$165
OTG5002C	Single Arm - Center	\$165
OTG5011	Pair of Connecting Brackets	\$45
OTG5004	Single Bench	\$375
Total		\$1910

INstock components

					
OTG5001NA* Armless Single Seat \$580 <i>*Not UPSable</i>	OTG5002 Single Arm - Reversible \$165	OTG5002C Single Arm - Center \$165	OTG5003 Cushion Bridge \$225	OTG5004 Single Bench \$375	OTG5011 Pair of Connecting Brackets \$45/pair

Available immediately in the following textile:

Luxhide	Finish
	
BL20 Black	Chrome Frame



These models are available immediately from stock in Luxhide Black (BL20), but are available in additional textiles. Additional textiles would be subject to "standard" lead times. See page 204-207 for available textiles.

For specifications and dimensions see page 170.



Model	Description	List Price
OTG13012	Square Modular Ottoman	\$360
OTG13010	V-Shaped Modular Ottoman (\$570 each)	\$1140
OTG13011	Rectangular Modular Ottoman (\$465 each)	\$930
OTG13009	Wedge Ottoman	\$440
OTG13008	Half Round Ottoman	\$425
OTG13007	Round Ottoman	\$330
Total		\$3625

Model	Description	List Price
OTG13012	Square Modular Ottoman (\$360 each)	\$720
OTG13010	V-Shaped Modular Ottoman (\$570 each)	\$1140
OTG13011	Rectangular Modular Ottoman (\$465 each)	\$930
Total		\$2790

Model	Description	List Price
OTG13012	Square Modular Ottoman (\$360 each)	\$720
OTG13010	V-Shaped Modular Ottoman (\$570 each)	\$2280
Total		\$3000

INstock components



OTG13012
Square Modular Ottoman
\$360



OTG13011
Rectangular Modular Ottoman
\$465



OTG13010
V-Shaped Modular Ottoman
\$570



OTG13007
Round Ottoman
\$330



OTG13008
Half Round Ottoman
\$425



OTG13009
Wedge Shaped Ottoman
\$440

Optional Casters

C107SET4
Set of four casters for use on OTG13011, OTG13012, OTG13008 and OTG13009 \$50

C107RSET4
Set of four hard floor casters for use on OTG13011, OTG13012, OTG13008 and OTG13009 \$90

C107SET5
Set of five casters for use on OTG13010 \$60

C107RSET5
Set of five hard floor casters for use on OTG13010 \$110

C107SET6
Set of six casters for use on OTG13007 \$75

C107RSET6
Set of six hard floor casters for use on OTG13007 \$135

Available immediately in the following textiles:

Hudson



HD08 Grey



HD11 Carbon



These models are available immediately from stock in Hudson Grey (HD08) and Hudson Carbon (HD11), but are available in additional textiles. Additional textiles would be subject to "standard" lead times. See page 172-175 for available textiles.

For specifications and dimensions see page 170.

OTG13007 (page 141) shown in Hudson Meadow (HD06), OTG13008 shown in Hudson Grey (HD08) and OTG13010 shown in Hudson Cerulean (HD14).



OfficestoGo Stack, Nesting + Guest Seating



OTG11340B (pictured left) - page 150



OTG2809 page 144



OTG2782 page 145



OTG3918 page 147



OTG11820B page 145



OTG13050B page 147



OTG1220B page 155

OTG11341B (page 150) shown in Carrera Chili (CE92) and Flip Top Training Tables shown in Autumn Walnut (AWL) tops and Tungsten base finish.



OTG2809
Mesh Back Guest Chair List Price **\$455**



Key Feature



Molded armrests

Available immediately in the following textile:



Black Mesh fabric seat



See pages 172-175 for more information.



For specifications and dimensions see page 167.



OTG11512B
Mesh Back Guest Chair List Price **\$335**



Key Feature



Stylish back detail

Available only in the following textile:



Black Mesh fabric seat



For specifications and dimensions see page 166.



OTG2782
Guest Chair List Price **\$400**



Available immediately in the following textile:

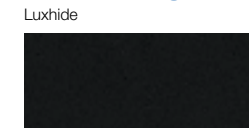

BL20 Black



See pages 172-175 for more information.



For specifications and dimensions see page 167.



OTG11820B(CX)
Wood Guest Chair - Cordovan Finish List Price **\$430**



OTG11820B(TH)
Wood Guest Chair - Toffee Finish List Price **\$430**

Available only in the following textile/finishes:



BL20 Black

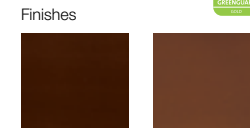

CX Cordovan **TH** Toffee



For specifications and dimensions see page 167.



OTG13050B (Shown with Casters - included)
Mesh Armchair List Price **\$330**



OTG13050B (Shown with Glides - included)
Mesh Armchair List Price **\$330**



OTG13050BT (Shown on OTG13050B)
Tablet only List Price **\$100**

Available only in the following textile:

Luxhide



BL20 Black



For specifications and dimensions see pages 156, 166, 171.



OTG3918B
Guest Chair List Price **\$300**



OTG11740B
Plastic Back Guest List Price **\$300**



Key Feature



Polyurethane arms

Available only in the following textile:

Quilt



QL10 Black



For specifications and dimensions see page 166.

Key Feature



Perforated back detail

Available only in the following finish + textile:

Polypropylene

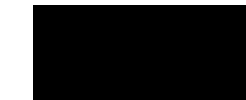

Black Polypropylene

Mesh



Black Mesh fabric seat



For specifications and dimensions see page 166.



OTG11923B
Mesh Back Guest Chair - Armless List Price **\$285**



OTG11923B Side View



OTG3915B
Luxhide Guest Chair List Price **\$305**



OTG11770BES - Espresso Finish
Luxhide Guest Chair with Wood Accents List Price **\$345**



OTG11920B
High Back Mesh Back Tilter List Price **\$390**



OTG11921B
Mid Back Mesh Back Tilter List Price **\$340**



OTG11922B
Mid Back Mesh Back Task - Armless List Price **\$285**

OTG11924
Adjustable Height Arm Kit List Price **\$80**



Available only in the following textile:

Mesh



Black Mesh fabric seat

For specifications and dimensions see pages 156, 166, 171.



Available only in the following textile:

Luxhide



BL20 Black



For specifications and dimensions see page 166.



OTG11770BCX - Cordovan Finish
Luxhide Guest Chair with Wood Accents List Price **\$345**

Available only in the following textile/finishes:

Luxhide



BL20 Black

Finishes



CX Cordovan



ES Espresso



For specifications and dimensions see page 167.



OTG11892
Guest Chair List Price **\$340**



Available immediately in the following textile:



QL10 Black



See pages 172-175 for more information.



OTG11341B
Armless Mesh Back Flip Seat Nesting Chair List Price **\$355**

In stock models available. Please check stock prior to ordering. 2 Day Ship + Special Order fabric options are suspended until further notice.



OTG11340B*
Mesh Back Flip Seat Nesting Chair (nested) List Price **\$400**
**Not UPSable*

In stock models available. Please check stock prior to ordering. 2 Day Ship + Special Order fabric options are suspended until further notice.

Available immediately in the following textile:



Black Mesh fabric seat



See pages 172-175 for more information.



For specifications and dimensions see page 169.



OTG11760B
Mesh Guest Chair List Price **\$260**



Available immediately in the following textile:



Black Mesh fabric seat



For specifications and dimensions see page 166.



OTG11761B
Armless Mesh Guest Chair with Casters List Price **\$245**



Available only in the following textile:



Black Mesh fabric seat



For specifications and dimensions see page 166.



OTG11703
Stack

List Price **\$225**



OTG11697 Shown stacked on optional dolly (OTG11698 - not stocked)
Armless Stack

List Price **\$170**



OTG2748
Armless Stack

List Price **\$180**



OTG11934
Armless Stack

List Price **\$140**



OTG11704
Armless Stack

List Price **\$200**



OTG11698
Dolly

List Price **\$300**



GC3010
Dolly

List Price **\$250**



Shown stacked on optional dolly (OTG11705)

OTG11705
Dolly

List Price **\$145**

Available immediately in the following textile:



QL10 Black



See pages 172-175 for more information.



Available immediately in the following textile:



QL10 Black



See pages 172-175 for more information.



Available immediately in the following textile:



QL10 Black



See pages 172-175 for more information.



Available immediately in the following textile:



QL10 Black

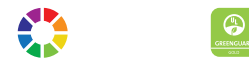

See pages 172-175 for more information.





OTG11310B
Medium Density stacking
Not UPSable List Price **\$160**

Can be stacked up to 8 high on the floor or 24 high on dolly.



OTG11310B Side View



Shown stacked 8 high on floor

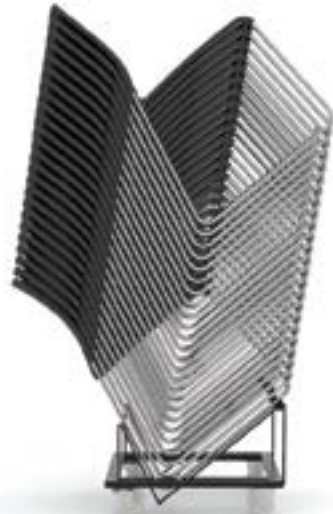

Shown stacked 24 high on optional dolly (OTG11311B)



OTG11311B
Dolly
List Price **\$290**

Dolly can accommodate 24 stacked chairs!



OTG11312
Connectors - Use 2 for each connection
List Price **\$25**



OTG11313
Glides (priced per pair)
List Price **\$20**



Available only in the following finish:

Polypropylene



Black

For specifications and dimensions see page 168.



OTG1220B
Stack List Price **\$190**

Can be stacked up to 5 high on the floor.



OTG11700
Plastic Back Stack List Price **\$180**

Can be stacked up to 12 high on the floor or dolly.



OTG1221B
Armless Stack List Price **\$175**

Can be stacked up to 5 high on the floor.



OTG11701
Dolly
List Price **\$195**

Dolly can accommodate 12 stacked chairs!

Available only in the following finish:

Polypropylene



Black

For specifications and dimensions see page 168.

Available only in the following finish:

Polypropylene



Black

For specifications and dimensions see page 168.





OTG11642B - pages 107, 116
 Mesh Back Task - Armless
 Dimensions: 19w x 20d x 37h
 Ergonomic Features: C, M, N, S

- Black mesh back with breathable Black mesh fabric seat
- Pneumatic seat height adjustment
- Armless design - height adjustable arms (OTG11620) are available
- Swivel task mechanism
- Twin wheel carpet casters
- Drafting stool kit (OTG11600) available (pages 107, 116, 117, 136, 137)
- Soft casters (OTG10700) are available (page 171)

List Price **\$260**



OTG11922B - pages 113, 116, 148
 Mesh Back Task - Armless
 Dimensions: 20w x 23d x 38h
 Ergonomic Features: C, M, N

- Mid back design
- Black mesh back with breathable Black air mesh fabric seat
- Pneumatic seat height adjustment
- Armless design - height adjustable arms (OTG11924) are available
- Swivel task mechanism with single position tilt lock and tilt tension adjustment
- Twin wheel carpet casters
- Drafting stool kit (OTG11600) available (pages 107, 116, 117, 136, 137)
- Soft casters (OTG10701) are available (page 171)

List Price **\$285**



OTG11514B - page 108
 Mid Back Mesh Back Tilter
 Dimensions: 25w x 23d x 37h
 Ergonomic Features: A, B, C, H, M, N, S

- Black mesh back with breathable Black air mesh fabric seat
- Pneumatic seat height adjustment
- Height adjustable arms with polyurethane armrests
- Single position tilt lock with tilt tension adjustment
- Swivel task mechanism with single position tilt lock and tilt tension adjustment
- Twin wheel carpet casters
- Soft casters (OTG10700) are available (page 171)

List Price **\$325**



OTG11921B - pages 113, 148
 Mid Back Mesh Back Tilter
 Dimensions: 25w x 23d x 39h
 Ergonomic Features: A, B, C, H, M, N, S

- Mid back design
- Black mesh back with breathable Black air mesh fabric seat
- Pneumatic seat height adjustment
- Height adjustable arms with polyurethane armrests
- Tilter mechanism with single position tilt lock and tilt tension adjustment
- Twin wheel carpet casters
- Soft casters (OTG10701) are available (page 171)

List Price **\$340**



OTG11641B - page 107
 High Back Mesh Back Synchro-Tilter
 Dimensions: 25w x 23d x 43h
 Ergonomic Features: A, B, C, H, L, M, N, S

- Black mesh back with breathable Black mesh fabric seat
- Pneumatic seat height adjustment
- Height adjustable arms with polyurethane armrests
- Synchro-tilt chair control with tilt tension adjustment
- Single position tilt lock
- Twin wheel carpet casters
- Soft casters (OTG10700) are available (page 171)

List Price **\$410**



OTG11328B - page 111
 Mesh Back Task
 Dimensions: 26.5w x 24d x 43h
 Ergonomic Features: A, B, C, E, L, M, N

- Black mesh back with patterned Black fabric seat
- Pneumatic seat height adjustment
- Fixed height arms with polyurethane armrests
- Synchro-tilt chair control with tilt tension adjustment
- Seat slider mechanism
- Twin wheel carpet casters
- Soft casters (OTG10700) are available (page 171)

List Price **\$415**



OTG11686B - page 103
 Mid Back Mesh Back Synchro-Tilter
 Dimensions: 25.5w x 24.5d x 36h
 Ergonomic Features: A, B, C, H, L, M, N

- Black mesh back with breathable Black mesh fabric seat
- Pneumatic seat height adjustment
- Height adjustable arms with polyurethane armrests
- Synchro-tilt chair control with infinite position tilt lock
- Twin wheel carpet casters
- Soft casters (OTG10701) are available (page 171)

List Price **\$435**



OTG12110B - page 104
 Mesh Back Luxhide Tilter
 Dimensions: 25w x 25d x 41h
 Ergonomic Features: A, B, C, H, M, N, S

- Black mesh back with Black Luxhide seat
- Pneumatic seat height adjustment
- Height adjustable arms with polyurethane armrests
- Single position tilt lock with tilt tension adjustment
- Unique lumbar pad with flexible support
- Twin wheel carpet casters
- Soft casters (OTG10701) are available (page 171)

List Price **\$440**



OTG11320B - page 114
 Low Back Mesh Back Tilter
 Dimensions: 23w x 24d x 39.5h
 Ergonomic Features: A, B, C, H, M, N, S

- Black mesh back with breathable Black mesh fabric seat
- Pneumatic seat height adjustment
- Height adjustable arms
- Single position tilt lock with tilt tension adjustment
- Twin wheel carpet casters
- Soft casters (OTG10700) are available (page 171)

List Price **\$350**



OTG12112B - page 109
 Mesh Back Tilter
 Dimensions: 25w x 24d x 41h
 Ergonomic Features: A, B, C, H, M, N, S

- Black mesh back with black Luxhide seat
- Pneumatic seat height adjustment
- Height adjustable arms with polyurethane armrests
- Single position tilt lock with tilt tension adjustment
- Twin wheel carpet casters
- Soft casters (OTG10701) are available (page 171)

List Price **\$365**



OTG11647B - page 107
 Mid Back Mesh Back Synchro-Tilter
 Dimensions: 24.5w x 22d x 37h
 Ergonomic Features: A, B, C, H, L, M, N, S

- Black mesh back with breathable Black air mesh fabric seat
- Pneumatic seat height adjustment
- Height adjustable arms with polyurethane armrests
- Synchro-tilt chair control with tilt tension adjustment
- Single position tilt lock
- Twin wheel carpet casters
- Soft casters (OTG10700) are available (page 171)

List Price **\$370**



OTG11920B - pages 113, 148
 High Back Mesh Back Tilter
 Dimensions: 24w x 22.5d x 42h
 Ergonomic Features: A, B, C, H, M, N, S

- High back design
- Black mesh back with breathable Black air mesh fabric seat
- Pneumatic seat height adjustment
- Height adjustable arms with polyurethane armrests
- Tilter mechanism with single position tilt lock and tilt tension adjustment
- Twin wheel carpet casters
- Soft casters (OTG10701) are available (page 171)

List Price **\$390**



OTG10904B - page 110
 Mesh Back Synchro-Tilter
 Dimensions: 24w x 24d x 37.5h
 Ergonomic Features: A, B, C, H, L, M, N

- Black mesh back with breathable Black air mesh seat
- Pneumatic seat height adjustment
- Adjustable lumbar support
- Height adjustable arms with self-skinned urethane arm caps
- Synchro-tilt chair control with multiple-position tilt lock and tilt tension adjustment
- Twin wheel carpet casters
- Soft casters (OTG10701) are available (page 171)

List Price **\$450**



OTG11692 - page 101
 Mesh Tilter
 Dimensions: 24.5w x 25d x 38h
 Ergonomic Features: A, B, C, E, H, M, N, S

- Black mesh back with mock leather surround and perforated Luxhide seat
- Pneumatic seat height adjustment
- Height adjustable arms
- Single position tilt lock with tilt tension adjustment
- Seat depth adjustment
- Twin wheel carpet casters
- Soft casters (OTG10700) are available (page 171)

List Price **\$450**



OTG11516B - page 108
 High Back Mesh Back Synchro-Tilter
 Dimensions: 26.75w x 24d x 41.5h
 Ergonomic Features: A, B, C, H, L, M, N

- Black mesh back with breathable Black fabric seat
- Pneumatic seat height adjustment
- Height adjustable arms with polyurethane armrests
- Synchro-tilt chair control with single position tilt lock
- Twin wheel carpet casters
- Soft casters (OTG10700) are available (page 171)

List Price **\$455**



OTG11865B - page 109
 Mesh Back Tilter
 Dimensions: 27w x 25d x 38h
 Ergonomic Features: A, B, C, H, M, N, S

- Black mesh back with patterned Black fabric seat
- Pneumatic seat height adjustment
- Height adjustable arms with titanium accents
- Single position tilt lock with tilt tension adjustment
- Twin wheel carpet casters
- Soft casters (OTG10701) are available (page 171)

List Price **\$460**



A Tilt Tension
 Increase or decrease to match body weight. Allows you to rock comfortably, reducing muscle fatigue.



B Chair Tilt Lock
 Lock the tilt movement in position(s) to accommodate your working posture. Allows you to lock your chair in a comfortable and supportive position. (can be either single position or infinite style).



C Seat Height
 Raise or lower to allow your feet to rest flat on the floor. Avoids pressure under your thighs, easing blood flow.



D Back Height
 Raise or lower to position lumbar support in your lumbar area. Reduces likelihood of back pain.



E Seat Depth
 Change the depth of the seat to accommodate the length of your thighs. Keeps your back in contact with the backrest while avoiding pressure behind your knees.



G Back Angle
 Adjust to change the angle of your torso in relation to your thighs. Helps reduce disc pressure and relaxes your back muscles.



H Arm Height
 Raise or lower to support your forearms. Reduces muscular effort in neck and shoulders, minimizing risk of pain.



L Synchro-Tilt Movement
 Backrest reclines at a faster rate than the seat, increasing the angle between your torso and thighs. Enhances comfort and encourages dynamic body movement.



M Waterfall Seat Edge
 Reduces pressure at the back of the knee, contributing to good blood flow.



N Properly Contoured Cushions
 Support the body effectively, allowing you to sit longer without discomfort.



Q Width Adjustable Arms
 Allows outward movement of armrests to match shoulder breadth. Ensures armrests properly support forearms, reducing muscular effort in neck and shoulders.



R Arm Rotation
 Rotate armcap to support your forearm in various positions. Reduces muscular effort in neck and shoulders, minimizing risk of pain.



S Center-Tilt Movement
 Chair tilts from a pivot point under the center of the seat allowing you to rock. When your feet are well supported, blood flow is enhanced.



V Lumbar Depth Adjustment
 Increase or decrease curvature of the back to match the profile of your lower back. Enhances comfort and support in the lower lumbar area.



OTG11685B - page 103
 High Back Mesh Back Synchro-Tilter
 Dimensions: 25.5w x 24.5d x 41h
 Ergonomic Features: A, B, C, H, L, M, N

- Black mesh back with breathable Black mesh fabric seat
- Pneumatic seat height adjustment
- Height adjustable arms with polyurethane armrests
- Synchro-tilt chair control with infinite position tilt lock
- Twin wheel carpet casters
- Soft casters (OTG10701) are available (page 171)

List Price ***490**



OTG11980B - page 101
 Mesh Back Synchro-Tilter
 Dimensions: 26w x 24d x 44h
 Ergonomic Features: A, B, C, H, L, M, N

- Black mesh back with patterned Black fabric seat
- Pneumatic seat height adjustment
- Height adjustable arms with polyurethane armrests
- Synchro-tilt chair control with tilt tension adjustment
- Single position tilt lock
- Twin wheel carpet casters
- Soft casters (OTG10701) are available (page 171)

List Price ***515**



OTG3191 - page 100
 Mesh Back Synchro-Tilter
 Dimensions: 24.5w x 23d x 43h
 Ergonomic Features: A, B, C, H, L, M, N

- High back design
- Black mesh back with Black Luxhide seat
- Pneumatic seat height adjustment
- Height and width adjustable arms with polyurethane armrests
- Synchro-tilt mechanism with single position tilt lock and tilt tension adjustment
- Single position tilt lock
- Ratchet back height adjustment
- Twin wheel carpet casters
- Soft casters (OTG10701) are available (page 171)

List Price ***540**



OTG11769B - page 108
 Mesh Back Multi-Function
 Dimensions: 26.75w x 23.5d x 43h
 Ergonomic Features: A, B, C, D, E, G, H, M, N, Q, S

- Black mesh back with breathable Black mesh fabric seat
- Pneumatic seat height adjustment
- Height and width adjustable armrests
- Infinite seat tilt lock with tilt tension adjustment
- Back angle adjustment via internal ratchet
- Seat slider
- Twin wheel carpet casters
- Soft casters (OTG10700) are available (page 171)

List Price ***550**



OTG3103 - page 97
 Mesh Back Multi-Function
 Dimensions: 26w x 27d x 39.5h
 Ergonomic Features: A, B, C, E, G, H, M, N, S

- Black mesh back with breathable Black mesh fabric seat
- Pneumatic seat height adjustment
- Height adjustable arms
- Multi-function mechanism with seat depth adjustment
- Back angle adjustment
- Forward tilt mechanism
- Infinite seat tilt lock with tilt tension adjustment
- Height and depth adjustable lumbar support
- Seat slider mechanism
- Twin wheel carpet casters
- Soft casters (OTG10701) are available (page 171)

List Price ***695**



OTG2821 - page 99
 Mesh Seat and Back Synchro-Tilter
 Dimensions: 26w x 26.5d x 39.5h
 Ergonomic Features: A, B, C, H, L, M, N

- Black mesh back with Black mesh seat
- Pneumatic seat height adjustment
- Height adjustable arms
- Multiple-position tilt lock with anti-kick back feature
- Seat depth adjustment
- Adjustable lumbar support
- Synchro-tilt chair control with tilt tension adjustment
- Twin wheel carpet casters
- Soft casters (OTG10701) are available (page 171)

List Price ***740**



OTG11325B - page 100
 Mesh Back Synchro-Tilter
 Dimensions: 26w x 25d x 40h
 Ergonomic Features: A, B, C, H, L, M, N, R

- Black mesh back with patterned Black fabric seat
- Pneumatic seat height adjustment
- Height adjustable, rotatable, forward and rearward and side-to-side sliding armrests with polyurethane pads
- Black, vertically adjustable lumbar support
- Synchro-tilt chair control with tilt tension adjustment
- Single position tilt lock
- Polished Aluminum base
- Twin wheel carpet casters
- Soft casters (OTG10701) are available (page 171)

List Price ***570**



OTG2801 - page 99
 Mesh Synchro-Tilter
 Dimensions: 26w x 26.5d x 39.5h
 Ergonomic Features: A, B, C, H, L, M, N

- Black mesh back with breathable Black mesh fabric seat
- Pneumatic seat height adjustment
- Height adjustable arms
- Multi-position seat tilt lock with anti-kick back feature
- Adjustable lumbar support
- Synchro-tilt chair control with tilt tension adjustment
- Twin wheel carpet casters
- Soft casters (OTG10701) are available (page 171)

List Price ***590**



OTG2803 - page 99
 Mesh Multi-Function
 Dimensions: 26w x 26.5d x 39.5h
 Ergonomic Features: A, B, C, G, H, M, N, S

- Black mesh back with breathable Black mesh fabric seat
- Pneumatic seat height adjustment
- Height adjustable arms
- Adjustable lumbar support
- Infinite seat tilt lock with tilt tension adjustment
- Back angle adjustment
- Forward tilt control
- Twin wheel carpet casters
- Soft casters (OTG10701) are available (page 171)

List Price ***615**



OTG3101 - page 97
 Mesh Back Synchro-Tilter
 Dimensions: 26w x 27d x 38.5h
 Ergonomic Features: A, B, C, E, H, L, M, N

- Black mesh back with Black Luxhide upholstered seat
- Pneumatic seat height adjustment
- Height adjustable arms
- Synchro-tilt mechanism
- Infinite seat tilt lock with tilt tension adjustment
- Height and depth adjustable lumbar support
- Twin wheel carpet casters
- Soft casters (OTG10701) are available (page 171)

List Price ***660**



OTG11685B
 Shown in Terrace Cherry Blossom (TC64).
 See pages 202-207 for additional color options.

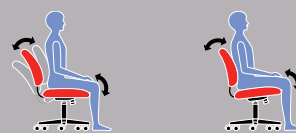

A Tilt Tension
 Increase or decrease to match body weight. Allows you to rock comfortably, without heavy pushing, reducing muscle fatigue.

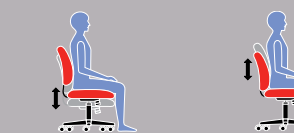

B Chair Tilt Lock
 Lock the tilt movement in position(s) to accommodate your working posture. Allows you to lock your chair in a comfortable and supportive position. (can be either single position or infinite style).



C Seat Height
 Raise or lower to allow your feet to rest flat on the floor. Avoids pressure under your thighs, easing blood flow.



D Back Height
 Raise or lower to position lumbar support in your lumbar area. Reduces likelihood of back pain.

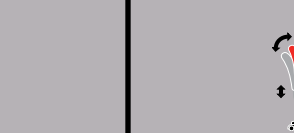

E Seat Depth
 Change the depth of the seat to accommodate the length of your thighs. Keeps your back in contact with the backrest while avoiding pressure behind your knees.



G Back Angle
 Adjust to change the angle of your torso in relation to your thighs. Helps reduce disc pressure and relaxes your back muscles.



H Arm Height
 Raise or lower to support your forearms. Reduces muscular effort in neck and shoulders, minimizing risk of pain.



L Synchro-Tilt Movement
 Backrest reclines at a faster rate than the seat, increasing the angle between your torso and thighs. Enhances comfort and encourages dynamic body movement.



M Waterfall Seat Edge
 Reduces pressure at the back of the knee, contributing to good blood flow.

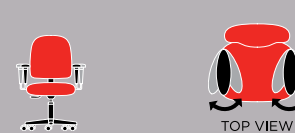

N Properly Contoured Cushions
 Support the body effectively, allowing you to sit longer without discomfort.



Q Width Adjustable Arms
 Allows outward movement of armrests to match shoulder breadth. Ensures armrests properly support forearms, reducing muscular effort in neck and shoulders.



R Arm Rotation
 Rotate armcap to support your forearm in various positions. Reduces muscular effort in neck and shoulders, minimizing risk of pain.

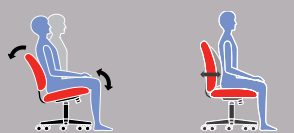

S Center-Tilt Movement
 Chair tilts from a pivot point under the center of the seat allowing you to rock. When your feet are well supported, blood flow is enhanced.



V Lumbar Depth Adjustment
 Increase or decrease curvature of the back to match the profile of your lower back. Enhances comfort and support in the lower lumbar area.



OTG11343B - page 117

Arm Mesh Task - Armless
 Dimensions: 19w x 23d x 37h
 Ergonomic Features: C, M, N

- Black air mesh fabric on back and seat with decorative accents
- Pneumatic seat height adjustment
- Armless design - height adjustable arms (OTG11620) are available
- Twin wheel carpet casters
- Drafting stool kit (OTG11600) available (pages 107, 116, 117, 136, 137)
- Soft casters (OTG10700) are available (page 171)

List Price ***210**



OTG11650 - page 117

Task - Armless
 Dimensions: 21w x 25d x 38h
 Ergonomic Features: C, E, M, N, S

- Patterned Black fabric upholstery
- Pneumatic seat height adjustment
- Seat depth adjustment
- Armless design - height adjustable arms (OTG11620) are available
- Twin wheel carpet casters
- Drafting stool kit (OTG11600) available (pages 107, 116, 117, 136, 137)
- Soft casters (OTG10700) are available (page 171)

List Price ***255**



OTG11612B - page 115

Tilter
 Dimensions: 26w x 26d x 36h
 Ergonomic Features: A, B, C, H, M, N, S

- Patterned Black fabric upholstery
- Pneumatic seat height adjustment
- Height adjustable armrests
- Single position tilt lock with tilt tension adjustment
- Fixed back angle
- Twin wheel carpet casters
- Soft casters (OTG10700) are available (page 171)

List Price ***325**



OTG11651 - page 105

Low Back Tilter
 Dimensions: 24w x 25.5d x 40h
 Ergonomic Features: A, B, C, H, N, S

- Patterned Black fabric upholstery
- Pneumatic seat height adjustment
- Height adjustable armrests
- Single position tilt lock with tilt tension adjustment
- Twin wheel carpet casters
- Soft casters (OTG10700) are available (page 171)

List Price ***330**



OTG11950B - page 110

Multi-Function
 Dimensions: 26.5w x 23.5d x 39h
 Ergonomic Features: A, B, C, D, E, G, H, M, N, S

- Patterned Black fabric upholstery
- Pneumatic seat height adjustment
- Height adjustable armrests
- Infinite seat tilt lock with tilt tension adjustment
- Back angle adjustment
- Back height adjustment via internal ratchet
- Seat slider
- Twin wheel carpet casters
- Soft casters (OTG10700) are available (page 171)

List Price ***440**



OTG11653 - page 104

Multi-Function
 Dimensions: 26.5w x 25d x 39h
 Ergonomic Features: A, B, C, D, G, H, M, N, R, S

- Patterned Black fabric upholstery
- Pneumatic seat height adjustment
- Height adjustable arms with pivot feature
- Infinite seat tilt lock with tilt tension adjustment
- Back angle adjustment
- Height adjustable lumbar support
- Twin wheel carpet casters
- Soft casters (OTG10700) are available (page 171)

List Price ***565**



OTG11850B - page 115

Tilter
 Dimensions: 25.5w x 23.5d x 38h
 Ergonomic Features: A, B, C, H, M, N, S

- Patterned Black fabric upholstery
- Pneumatic seat height adjustment
- Height adjustable arms with polyurethane armrests
- Single position tilt lock with tilt tension adjustment
- Fixed back angle
- Twin wheel carpet casters
- Soft casters (OTG10700) are available (page 171)

List Price ***345**



OTG11652 - page 105

High Back Tilter
 Dimensions: 26.5w x 25.5d x 42.5h
 Ergonomic Features: A, B, C, H, N, S

- Patterned Black fabric upholstery
- Pneumatic seat height adjustment
- Height adjustable armrests
- Single position tilt lock with tilt tension adjustment
- Twin wheel carpet casters
- Soft casters (OTG10700) are available (page 171)

List Price ***355**



OTG11715B - page 114

Synchro-Tilter
 Dimensions: 25.5w x 21.5d x 40.5h
 Ergonomic Features: A, B, C, H, L, M, N

- Patterned Black fabric upholstery
- Pneumatic seat height adjustment
- Height adjustable arms
- Synchro-tilt chair control with tilt tension adjustment
- Single position tilt lock
- Twin wheel carpet casters
- Soft casters (OTG10701) are available (page 171)

List Price ***390**



OTG11631B - page 111

Multi-Function
 Dimensions: 25.5w x 25d x 44h
 Ergonomic Features: A, B, C, D, G, H, M, N, S

- Patterned Black fabric upholstery
- Pneumatic seat height adjustment
- Height adjustable armrests
- Height adjustable lumbar support
- Twin wheel carpet casters
- Soft casters (OTG10700) are available (page 171)

List Price ***420**



OTG11710 - page 96

Multi-Function
 Dimensions: 26w x 24.5d x 42h
 Ergonomic Features: A, B, C, D, G, H, M, N, S

- Patterned Black fabric upholstery
- Pneumatic seat height adjustment
- Height and width adjustable armrests
- Infinite seat tilt lock with tilt tension adjustment
- Back angle adjustment
- Back height adjustment via internal ratchet
- Forward tilt control
- Twin wheel carpet casters
- Soft casters (OTG10700) are available (page 171)

List Price ***660**



OTG2913 - page 96

Multi-Function
 Dimensions: 25w x 24d x 41h
 Ergonomic Features: A, B, C, D, E, G, H, M, N, Q, S

- Black Luxhide upholstery with mock leather trim
- Pneumatic seat height adjustment
- Height and width adjustable armrests
- Infinite seat tilt lock with tilt tension adjustment
- Back angle adjustment
- Back height adjustment via internal ratchet
- Forward tilt control
- Seat depth adjustment via seat slider
- Twin wheel carpet casters
- Soft casters (OTG10701) are available (page 171)

List Price ***740**



OTG2913
 Shown in Luxhide White (BL28).
 See pages 202-207 for additional color options.



A Tilt Tension
 Increase or decrease to match body weight. Allows you to rock comfortably, reducing muscle fatigue.



B Chair Tilt Lock
 Lock the tilt movement in position(s) to accommodate your working posture. Allows you to lock your chair in a comfortable and supportive position. (can be either single position or infinite style).



C Seat Height
 Raise or lower to allow your feet to rest flat on the floor. Avoids pressure under your thighs, easing blood flow.



D Back Height
 Raise or lower to position lumbar support in your lumbar area. Reduces likelihood of back pain.



E Seat Depth
 Change the depth of the seat to accommodate the length of your thighs. Keeps your back in contact with the backrest while avoiding pressure behind your knees.



G Back Angle
 Adjust to change the angle of your torso in relation to your thighs. Helps reduce disc pressure and relaxes your back muscles.



H Arm Height
 Raise or lower to support your forearms. Reduces muscular effort in neck and shoulders, minimizing risk of pain.



L Synchro-Tilt Movement
 Backrest reclines at a faster rate than the seat, increasing the angle between your torso and thighs. Enhances comfort and encourages dynamic body movement.



M Waterfall Seat Edge
 Reduces pressure at the back of the knee, contributing to good blood flow.



N Properly Contoured Cushions
 Support the body effectively, allowing you to sit longer without discomfort.



Q Width Adjustable Arms
 Allows outward movement of armrests to match shoulder breadth. Ensures armrests properly support forearms, reducing muscular effort in neck and shoulders.



R Arm Rotation
 Rotate armcap to support your forearm in various positions. Reduces muscular effort in neck and shoulders, minimizing risk of pain.



S Center-Tilt Movement
 Chair tilts from a pivot point under the center of the seat allowing you to rock. When your feet are well supported, blood flow is enhanced.



V Lumbar Depth Adjustment
 Increase or decrease curvature of the back to match the profile of your lower back. Enhances comfort and support in the lower lumbar area.



OTG10900B - page 133
 Mesh Back Tilter
 Dimensions: 22.5w x 22.5d x 37h
 Ergonomic Features: A, B, C, M, N, S

- Grey mesh back with breathable Black mesh fabric seat
- Pneumatic seat height adjustment
- Molded arms
- Single position tilt lock with tilt tension adjustment
- Twin wheel carpet casters
- Soft casters (OTG10701) are available (page 171)

List Price ***225**



OTG10901B - page 132
 Mesh Back Tilter
 Dimensions: 23.5w x 22d x 34h
 Ergonomic Features: A, B, C, M, N, S

- Black mesh back with breathable Black mesh fabric seat
- Pneumatic seat height adjustment
- Molded arms
- Single position tilt lock with tilt tension adjustment
- Chrome accent on outer back
- Twin wheel carpet casters
- Soft casters (OTG10701) are available (page 171)

List Price ***250**



OTG10902B - page 133
 Mesh Back Tilter
 Dimensions: 23w x 24d x 39h
 Ergonomic Features: A, B, C, M, N, S

- Grey mesh back with breathable Black mesh fabric seat
- Pneumatic seat height adjustment
- Molded arms
- Single position tilt lock with tilt tension adjustment
- Twin wheel carpet casters
- Soft casters (OTG10701) are available (page 171)

List Price ***250**



OTG13026B - page 135
 Mesh Low Back Tilter
 Dimensions: 23w x 23.5d x 40h
 Ergonomic Features: A, B, C, M, N, S

- Black mesh back with Black Luxhide mesh seat
- Pneumatic seat height adjustment
- Fixed "twisted ribbon" molded arms
- Single position tilt lock with tilt tension adjustment
- Twin wheel carpet casters
- Soft casters (OTG10701) are available (page 171)

List Price ***330**



OTG11776B - page 131
 Luxhide Tilter
 Dimensions: 24.5w x 25d x 41.5h
 Ergonomic Features: A, B, C, M, N, S

- Black Luxhide upholstery with mock leather trim
- Pneumatic seat height adjustment
- Fixed height molded arms
- Single position tilt lock with tilt tension adjustment
- Twin wheel carpet casters
- Soft casters (OTG10700) are available (page 171)

List Price ***265**



OTG11782B - page 131
 Luxhide Tilter
 Dimensions: 25w x 26d x 46h
 Ergonomic Features: A, B, C, M, N, S

- Black Luxhide upholstery with mock leather trim
- Pneumatic seat height adjustment
- Fixed height molded arms with upholstered inset cap
- Single position tilt lock with tilt tension adjustment
- Twin wheel carpet casters
- Soft casters (OTG10700) are available (page 171)

List Price ***335**



OTG11617B - page 130
 Luxhide Tilter
 Dimensions: 26w x 27d x 42.5h
 Ergonomic Features: A, B, C, N, S

- Black Luxhide upholstery with mock leather trim
- Pneumatic seat height adjustment
- Fixed height molded arms with padded armrests
- Single position tilt lock with tilt tension adjustment
- Twin wheel carpet casters
- Soft casters (OTG10700) are available (page 171)

List Price ***370**



OTG11975B - page 130
 Luxhide Tilter
 Dimensions: 28w x 23d x 41.5h
 Ergonomic Features: A, B, C, M, N, S

- Black Luxhide upholstery with mock leather trim
- Pneumatic seat height adjustment
- Fixed height molded arms with upholstered armrests
- Single position tilt lock with tilt tension adjustment
- Twin wheel carpet casters
- Soft casters (OTG10700) are available (page 171)

List Price ***380**



OTG11750B - page 132
 Mesh Back Tilter
 Dimensions: 27w x 24d x 40.5h
 Ergonomic Features: A, B, C, M, N, S

- Black mesh back with breathable Black mesh fabric seat
- Pneumatic seat height adjustment
- Fixed height upholstered armrests
- Single position tilt lock with tilt tension adjustment
- Twin wheel carpet casters
- Soft casters (OTG10700) are available (page 171)

List Price ***335**



OTG11657B - page 127
 Mesh Back Tilter
 Dimensions: 24w x 23.5d x 41h
 Ergonomic Features: A, B, C, M, N, S

- Black mesh back with breathable Black mesh fabric seat
- Pneumatic seat height adjustment
- Aluminum arms with padded armrests (arms can be removed to achieve a fully polished look)
- Single position tilt lock with tilt tension adjustment
- Twin wheel carpet casters
- Soft casters (OTG10700) are available (page 171)

List Price ***420**



OTG11790B - page 126
 Mesh Back Knee-Tilter
 Dimensions: 23w x 25d x 38.5h
 Ergonomic Features: A, B, C, M, N, S

- Black mesh back with breathable Black mesh fabric seat
- Pneumatic seat height adjustment
- Polished Aluminum arms with polyurethane armrests
- Knee-tilt mechanism with multiple position tilt lock
- Twin wheel carpet casters
- Soft casters (OTG10700) are available (page 171)

List Price ***505**



OTG2788 - page 126
 Luxhide Tilter
 Dimensions: 25.5w x 27.5d x 42h
 Ergonomic Features: A, B, C, M, N, S

- Black Luxhide upholstery with mock leather trim
- Pneumatic seat height adjustment
- Black molded arms
- Single position tilt lock with tilt tension adjustment
- Twin wheel carpet casters
- Soft casters (OTG10700) are available (page 171)

List Price ***465**



OTG11858B - page 120
 Luxhide Segmented Cushion Tilter
 Dimensions: 25.5w x 26d x 44.5h
 Ergonomic Features: A, B, C, M, N, S

- Black Luxhide upholstery with mock leather trim
- Pneumatic seat height adjustment
- Chrome arms with upholstered armrests
- Single position tilt lock
- Swivel/tilt mechanism with tilt tension adjustment
- Twin wheel carpet casters
- Soft casters (OTG10700) are available (page 171)

List Price ***480**



OTG11735 - page 125
 Mid Back Luxhide Tilter - Armless
 Dimensions: 23.5w x 24.5d x 38h
 Ergonomic Features: A, B, C, M, N, S

- Black Luxhide upholstery with mock leather trim
- Pneumatic seat height adjustment
- Single position tilt lock with tilt tension adjustment
- Twin wheel carpet casters
- Soft casters (OTG10700) are available (page 171)

List Price ***485**



OTG11618B - page 121
 Luxhide Tilter
 Dimensions: 25.5w x 30d x 44.5h
 Ergonomic Features: A, B, C, M, N, S

- Black Luxhide upholstery with mock leather trim
- Pneumatic seat height adjustment
- Fixed height molded arms with padded armrests
- Single position tilt lock with tilt tension adjustment
- Integrated headrest
- Twin wheel carpet casters
- Soft casters (OTG10700) are available (page 171)

List Price ***485**

A Tilt Tension
 Increase or decrease to match body weight. Allows you to rock comfortably, reducing muscle fatigue.

B Chair Tilt Lock
 Lock the tilt movement in position(s) to accommodate your working posture. Allows you to lock your chair in a comfortable and supportive position. (can be either single position or infinite style).

C Seat Height
 Raise or lower to allow your feet to rest flat on the floor. Avoids pressure under your thighs, easing blood flow.

D Back Height
 Raise or lower to position lumbar support in your lumbar area. Reduces likelihood of back pain.

E Seat Depth
 Change the depth of the seat to accommodate the length of your thighs. Keeps your back in contact with the backrest while avoiding pressure behind your knees.

G Back Angle
 Adjust to change the angle of your torso in relation to your thighs. Helps reduce disc pressure and relaxes your back muscles.

H Arm Height
 Raise or lower to support your forearms. Reduces muscular effort in neck and shoulders, minimizing risk of pain.

L Synchro-Tilt Movement
 Backrest reclines at a faster rate than the seat, increasing the angle between your torso and thighs. Enhances comfort and encourages dynamic body movement.

M Waterfall Seat Edge
 Reduces pressure at the back of the knee, contributing to good blood flow.

N Properly Contoured Cushions
 Support the body effectively, allowing you to sit longer without discomfort.

Q Width Adjustable Arms
 Allows outward movement of armrests to match shoulder breadth. Ensures armrests properly support forearms, reducing muscular effort in neck and shoulders.

R Arm Rotation
 Rotate armcap to support your forearm in various positions. Reduces muscular effort in neck and shoulders, minimizing risk of pain.

S Center-Tilt Movement
 Chair tilts from a pivot point under the center of the seat allowing you to rock. When your feet are well supported, blood flow is enhanced.

V Lumbar Depth Adjustment
 Increase or decrease curvature of the back to match the profile of your lower back. Enhances comfort and support in the lower lumbar area.



OTG11734B - page 125
 Mid Back Luxhide Tilter
 Dimensions: 23.5w x 24.5d x 38h
 Ergonomic Features: A, B, C, M, N, S

- Black Luxhide upholstery with mock leather trim
- Pneumatic seat height adjustment
- Polished Aluminum arms (arms can be removed to achieve a sleek look)
- Single position tilt lock with tilt tension adjustment
- Twin wheel carpet casters
- Soft casters (OTG10700) are available (page 171)

List Price ***485**



OTG2701 - page 123
 Mid Back Luxhide Tilter
 Dimensions: 27w x 28d x 39h
 Ergonomic Features: A, B, C, M, N, S

- Black Luxhide upholstery with mock leather trim
- Pneumatic seat height adjustment
- Polyurethane "reverse curve" arms
- Single position tilt lock with tilt tension adjustment
- Twin wheel carpet casters
- Soft casters (OTG10700) are available (page 171)

List Price ***505**



OTG11786B - page 129
 Specialty Luxhide Tilter
 Dimensions: 24.5w x 25d x 41.5h
 Ergonomic Features: A, B, C, M, N, S

- Black Luxhide upholstery with mock leather trim
- Pneumatic seat height adjustment
- Chrome plated steel base
- Tilt tension adjustment
- Twin wheel carpet casters
- Soft casters (OTG10700) are available (page 171)

List Price ***515**



OTG11732 - page 125
 High Back Luxhide Tilter - Armless
 Dimensions: 23.5w x 24.5d x 40h
 Ergonomic Features: A, B, C, M, N, S

- Black or White Luxhide upholstery with mock leather trim
- Pneumatic seat height adjustment
- Single position tilt lock with tilt tension adjustment
- Twin wheel carpet casters
- Soft casters (OTG10700) are available (page 171)

List Price ***520**



OTG11730B - page 125
 High Back Luxhide Tilter
 Dimensions: 23.5w x 24.5d x 40h
 Ergonomic Features: A, B, C, M, N, S

- Black or White Luxhide upholstery with mock leather trim
- Pneumatic seat height adjustment
- Polished Aluminum arms (arms can be removed to achieve a sleek look)
- Single position tilt lock with tilt tension adjustment
- Twin wheel carpet casters
- Soft casters (OTG10700) are available (page 171)

List Price ***520**



OTG2700 - page 123
 High Back Luxhide Tilter
 Dimensions: 27w x 28d x 42h
 Ergonomic Features: A, B, C, M, N, S

- Black Luxhide upholstery with mock leather trim
- Pneumatic seat height adjustment
- Polyurethane "reverse curve" arms
- Single position tilt lock with tilt tension adjustment
- Twin wheel carpet casters
- Soft casters (OTG10700) are available (page 171)

List Price ***525**



OTG11300B - page 121
 Luxhide Tilter with Wood Arms and Base
 Dimensions: 28.5w x 28d x 45h
 Ergonomic Features: A, B, C, N, S

- Black Luxhide upholstery with mock leather trim
- Pneumatic seat height adjustment
- Padded armrests
- Single position tilt lock with tilt tension adjustment
- Integral headrest
- Wood arms and wood capped base in Cordovan (CX) finish
- Twin wheel carpet casters
- Soft casters (OTG10701) are available (page 171)

List Price ***550**



OTG11648B - page 120
 Luxhide Segmented Tilter
 Dimensions: 24.5w x 24.5d x 41h
 Ergonomic Features: A, B, C, M, N, S

- Black Luxhide upholstery with mock leather trim
- Pneumatic seat height adjustment
- Chrome arms with upholstered armrests (arms can be removed to achieve a sleek look)
- Single position tilt lock
- Swivel/tilt mechanism with tilt tension adjustment
- Twin wheel carpet casters
- Soft casters (OTG10700) are available (page 171)

List Price ***575**



OTG11786B
 Shown in Luxhide Saddle (BL23).
 See pages 202-207 for additional color options.



A Tilt Tension
 Increase or decrease to match body weight. Allows you to rock comfortably, without heavy pushing, reducing muscle fatigue.



B Chair Tilt Lock
 Lock the tilt movement in position(s) to accommodate your working posture. Allows you to lock your chair in a comfortable and supportive position. (can be either single position or infinite style).



C Seat Height
 Raise or lower to allow your feet to rest flat on the floor. Avoids pressure under your thighs, easing blood flow.



D Back Height
 Raise or lower to position lumbar support in your lumbar area. Reduces likelihood of back pain.



E Seat Depth
 Change the depth of the seat to accommodate the length of your thighs. Keeps your back in contact with the backrest while avoiding pressure behind your knees.



G Back Angle
 Adjust to change the angle of your torso in relation to your thighs. Helps reduce disc pressure and relaxes your back muscles.



H Arm Height
 Raise or lower to support your forearms. Reduces muscular effort in neck and shoulders, minimizing risk of pain.



L Synchro-Tilt Movement
 Backrest reclines at a faster rate than the seat, increasing the angle between your torso and thighs. Enhances comfort and encourages dynamic body movement.



M Waterfall Seat Edge
 Reduces pressure at the back of the knee, contributing to good blood flow.



N Properly Contoured Cushions
 Support the body effectively, allowing you to sit longer without discomfort.



Q Width Adjustable Arms
 Allows outward movement of armrests to match shoulder breadth. Ensures armrests properly support forearms, reducing muscular effort in neck and shoulders.



R Arm Rotation
 Rotate armcap to support your forearm in various positions. Reduces muscular effort in neck and shoulders, minimizing risk of pain.



S Center-Tilt Movement
 Chair tilts from a pivot point under the center of the seat allowing you to rock. When your feet are well supported, blood flow is enhanced.



V Lumbar Depth Adjustment
 Increase or decrease curvature of the back to match the profile of your lower back. Enhances comfort and support in the lower lumbar area.

**OTG11761B** - page 151

Armless Mesh Back Guest Chair with Casters

Dimensions: 20.5w x 22.5d x 35h

Ergonomic Features: M, N

- Black mesh back with breathable Black mesh fabric seat
- Four leg design with casters
- Does not stack
- Soft casters (OTG10701) are available (page 171)

List Price ***245**

**OTG11760B** - page 151

Mesh Back Guest Chair

Dimensions: 23.5w x 23.25d x 34h

Ergonomic Features: M, N

- Black mesh back with breathable Black mesh fabric seat
- Four leg design with molded armrests
- Does not stack

List Price ***260**

**OTG11923B** - pages 113, 148

Armless Mesh Back Guest Chair

Dimensions: 20.75w x 22d x 38h

Ergonomic Features: M, N

- Black mesh back with breathable Black air mesh fabric seat
- Powder coated cantilever base
- Chair frame glides
- Does not stack

List Price ***285**

**OTG11740B** - page 147

Plastic Back Guest Chair

Dimensions: 24.5w x 22.5d x 34h

Ergonomic Features: M, N

- Perforated plastic back with Black mesh fabric seat
- Oval tube chrome frame with molded armrests
- Can be stacked up to 5 high
- Packed 2 chairs per carton (priced each)

List Price ***300**

**OTG11892** - page 150

Guest

Dimensions: 23w x 26.5d x 34h

Ergonomic Features: M, N

- Patterned Black fabric upholstery
- Mid-back design
- Sled base design with Black powder coated steel frame
- Upholstered armrests

List Price ***340**

**OTG11770BCX** - page 149

Luxhide Guest Chair with Wood Accents

Dimensions: 24w x 26d x 34.5h

Ergonomic Features: M, N

- Black Luxhide with mock leather trim
- Cordovan (CX) finished wood arms and legs

List Price ***345**

**OTG11770BES** - page 149

Luxhide Guest Chair with Wood Accents

Dimensions: 24w x 26d x 34.5h

Ergonomic Features: M, N

- Black Luxhide with mock leather trim
- Espresso (ES) finished wood arms and legs

List Price ***345**

**OTG2782** - pages 123, 145

Luxhide Guest

Dimensions: 24.5w x 25.5d x 36.5h

Ergonomic Features: M, N

- Black Luxhide upholstery with mock leather trim
- Attractive sled base design
- Upholstered armrests

List Price ***400**

**NEW****OTG3918B** - page 147

Guest

Dimensions: 24.5w x 24d x 34h

Ergonomic Features: M, N

- Black fabric upholstered seat and back
- Comfortable polyurethane arms
- Black powder coated steel frame
- 4 leg design

List Price ***300**

**OTG3915B** - page 149

Luxhide Guest

Dimensions: 24.5w x 27d x 33.5h

Ergonomic Features: M, N

- Black Luxhide upholstery with mock leather trim
- Black epoxy powder coated steel frame with upholstered armrests

List Price ***305**

**NEW****OTG13050B** - pages 135, 146

Low Back Mesh Armchair with Luxhide Seat

Dimensions: 23w x 23.5d x 36.5h

Ergonomic Features: M, N

- Black mesh back with Black Luxhide seat
- Fixed "twisted ribbon" molded arms
- Black painted steel frame
- Can be fitted with either glides or carpet casters (both are included)

List Price ***330**

OTG13050BT - pages 135, 146

Tablet

List Price ***100**

**OTG11512B** - page 144

Mesh Back Guest Chair

Dimensions: 22w x 24d x 33.5h

Ergonomic Features: M, N

- Black mesh back with Black air mesh seat
- Polyurethane arm caps
- Black powder coated steel frame

List Price ***335**

**NEW****OTG11820B(CX)** - page 145

Wood Guest

Dimensions: 23w x 23d x 32.5h

Ergonomic Features: M, N

- Black Luxhide seat upholstery
- Sophisticated wood frame design
- Cordovan (CX) finish

List Price ***430**

**OTG11820B(TH)** - page 145

Wood Guest

Dimensions: 23w x 23d x 32.5h

Ergonomic Features: M, N

- Black Luxhide seat upholstery
- Sophisticated wood frame design
- Toffee (TH) finish

List Price ***430**

**NEW****OTG2809** - page 144

Mesh Back Guest

Dimensions: 22.25w x 24d x 34.5h

Ergonomic Features: M, N

- Black mesh back with Black mesh fabric seat
- Molded armrests
- Four leg design

List Price ***455**

**A Tilt Tension**

Increase or decrease to match body weight. Allows you to rock comfortably, reducing muscle fatigue.

**B Chair Tilt Lock**

Lock the tilt movement in position(s) to accommodate your working posture. Allows you to lock your chair in a comfortable and supportive position. (can be either single position or infinite style).

**C Seat Height**

Raise or lower to allow your feet to rest flat on the floor. Avoids pressure under your thighs, easing blood flow.

**D Back Height**

Raise or lower to position lumbar support in your lumbar area. Reduces likelihood of back pain.

**E Seat Depth**

Change the depth of the seat to accommodate the length of your thighs. Keeps your back in contact with the backrest while avoiding pressure behind your knees.

**G Back Angle**

Adjust to change the angle of your torso in relation to your thighs. Helps reduce disc pressure and relaxes your back muscles.

**H Arm Height**

Raise or lower to support your forearms. Reduces muscular effort in neck and shoulders, minimizing risk of pain.

**L Synchro-Tilt Movement**

Backrest reclines at a faster rate than the seat, increasing the angle between your torso and thighs. Enhances comfort and encourages dynamic body movement.

**M Waterfall Seat Edge**

Reduces pressure at the back of the knee, contributing to good blood flow.

**N Properly Contoured Cushions**

Support the body effectively, allowing you to sit longer without discomfort.

**Q Width Adjustable Arms**

Allows outward movement of armrests to match shoulder breadth. Ensures armrests properly support forearms, reducing muscular effort in neck and shoulders.

**R Arm Rotation**

Rotate armcap to support your forearm in various positions. Reduces muscular effort in neck and shoulders, minimizing risk of pain.

**S Center-Tilt Movement**

Chair tilts from a pivot point under the center of the seat allowing you to rock. When your feet are well supported, blood flow is enhanced.

**V Lumbar Depth Adjustment**

Increase or decrease curvature of the back to match the profile of your lower back. Enhances comfort and support in the lower lumbar area.



OTG11934 - page 153
 Armless Stack
 Dimensions: 17.5w x 22.5d x 33.5h
 Ergonomic Features: M, N

- Patterned Black fabric upholstery
- Black powder coated steel frame
- Floor and stack bumpers
- Can be stacked 10 high on optional dolly (OTG11705)
- Packed 2 per carton (priced each)

List Price **\$140**
OTG11705 Dolly - page 153
 List Price **\$145**



OTG11310B - page 154
 Medium Density Stacking
 Dimensions: 18.25w x 20.5d x 32h

- Impact resistant Black plastic seat and back (one piece)
- Chrome plated steel rod frame
- Can be stacked 8 high on the floor or 24 high on dolly (OTG11311B)
- Packed 4 per carton (priced each)

List Price **\$160**
OTG11311B Dolly - page 154
 List Price **\$290**
OTG11312 Connectors - page 154
 List Price **\$25**
OTG11313 Glides - page 154
 List Price **\$20** (per pair)



OTG11697 - page 152
 Armless Stack
 Dimensions: 18.5w x 23.5d x 30h
 Ergonomic Features: M, N

- Patterned Black fabric upholstery
- Tubular chrome frame
- Can be stacked 13 high on the floor or 15 high on optional dolly (OTG11698)
- Packed 2 per carton (priced each)

List Price **\$170**
OTG11698 Dolly - page 152
 List Price **\$300**



OTG1221B - page 155
 Armless Stack
 Dimensions: 18w x 21d x 31.5h

- Impact resistant Black plastic seat and back
- Chrome steel frame
- Can be stacked 5 high on the floor
- Packed 4 per carton (priced each)

List Price **\$175**



OTG11703 - page 152
 Stack
 Dimensions: 21.5w x 23d x 30.5h
 Ergonomic Features: M, N

- Patterned Black fabric upholstery
- Black powder coated frame
- Can be stacked 4 high on optional dolly (OTG11706)
- Packed 2 per carton (priced each)

List Price **\$225**
OTG11706 Dolly - page 152
 List Price **\$250**



OTG11700 - page 155
 Armless Plastic Back Stack
 Dimensions: 22w x 22.5d x 31h

- Impact resistant Black plastic seat and back
- Chrome steel frame
- Can be stacked 12 high with or without optional dolly (OTG11701)
- Packed 2 per carton (priced each)

List Price **\$180**
OTG11701 Dolly - page 155
 List Price **\$195**



OTG2748 - page 153
 Armless Stack
 Dimensions: 19.5w x 22.5d x 32h
 Ergonomic Features: M, N

- Patterned Black fabric upholstery
- Black powder coated frame
- Can be stacked 4 high with or without optional dolly (GC3010)
- Packed 2 per carton (priced each)

List Price **\$180**
GC3010 Dolly - page 153
 List Price **\$240**



OTG1220B - page 155
 Stack
 Dimensions: 21.5w x 21d x 31.5h

- Impact resistant Black plastic seat and back
- Chrome steel frame
- Can be stacked 5 high on the floor
- Packed 4 per carton (priced each)

List Price **\$190**



OTG11704 - page 152
 Armless Stack
 Dimensions: 21.5w x 23d x 30.5h
 Ergonomic Features: M, N

- Patterned Black fabric upholstery
- Black powder coated frame
- Can be stacked 4 high on optional dolly (OTG11706)
- Packed 2 per carton (priced each)

List Price **\$200**
OTG11706 Dolly - page 152
 List Price **\$250**



OTG11341B - page 150
 Armless Mesh Back Flip Seat Nesting
 Dimensions: 22w x 22d x 33h
 Ergonomic Features: M, N

- Black mesh back with breathable Black air mesh fabric seat
- Flip seat design allows chair to be nested horizontally
- Black painted steel frame
- Swivelling carpet casters
- Does not stack
- Packed 2 per carton (priced each)
- Soft casters (OTG10701) are available (page 171)

List Price **\$355**



OTG11340B - page 150
 Mesh Back Flip Seat Nesting
 Dimensions: 25.5w x 22d x 33h
 Ergonomic Features: M, N

- Black mesh back with breathable Black air mesh fabric seat
- Black polypropylene arms
- Flip seat design allows chair to be nested horizontally
- Black painted steel frame
- Swivelling carpet casters
- Does not stack
- Packed 2 per carton (priced each)
- Soft casters (OTG10701) are available (page 171)

List Price **\$400**



A Tilt Tension
 Increase or decrease to match body weight. Allows you to rock comfortably, reducing muscle fatigue.



B Chair Tilt Lock
 Lock the tilt movement in position(s) to accommodate your working posture. Allows you to lock your chair in a comfortable and supportive position. (can be either single position or infinite style).



C Seat Height
 Raise or lower to allow your feet to rest flat on the floor. Avoids pressure under your thighs, easing blood flow.



D Back Height
 Raise or lower to position lumbar support in your lumbar area. Reduces likelihood of back pain.



E Seat Depth
 Change the depth of the seat to accommodate the length of your thighs. Keeps your back in contact with the backrest while avoiding pressure behind your knees.



G Back Angle
 Adjust to change the angle of your torso in relation to your thighs. Helps reduce disc pressure and relaxes your back muscles.



H Arm Height
 Raise or lower to support your forearms. Reduces muscular effort in neck and shoulders, minimizing risk of pain.



L Synchro-Tilt Movement
 Backrest reclines at a faster rate than the seat, increasing the angle between your torso and thighs. Enhances comfort and encourages dynamic body movement.



M Waterfall Seat Edge
 Reduces pressure at the back of the knee, contributing to good blood flow.



N Properly Contoured Cushions
 Support the body effectively, allowing you to sit longer without discomfort.



Q Width Adjustable Arms
 Allows outward movement of armrests to match shoulder breadth. Ensures armrests properly support forearms, reducing muscular effort in neck and shoulders.



R Arm Rotation
 Rotate armcap to support your forearm in various positions. Reduces muscular effort in neck and shoulders, minimizing risk of pain.



S Center-Tilt Movement
 Chair tilts from a pivot point under the center of the seat allowing you to rock. When your feet are well supported, blood flow is enhanced.



V Lumbar Depth Adjustment
 Increase or decrease curvature of the back to match the profile of your lower back. Enhances comfort and support in the lower lumbar area.



OTG5002 - page 139
Single Arm - Reversible
Dimensions: 3w x 18.5d x 9h
List Price ***165**



OTG5002C - page 139
Single Arm - Center
Used to define seating areas
Dimensions: 3w x 18.5d x 9h
List Price ***165**



OTG5003 - page 139
Cushion Bridge
Can be used for seating applications and will support a person's weight
Dimensions: 25w x 22d x 4h
List Price ***225**



OTG5004 - page 139
Single Bench
Dimensions: 25w x 23d x 17.5h
List Price ***375**



OTG5001NA - page 139
Armless Single Seat
Dimensions: 25w x 29d x 30.5h
List Price ***580**



OTG5011 - page 139
Pair of Connecting Brackets
List Price ***45/pair**



OTG13012 - page 141
Square Shaped Modular Ottoman
Snap-in bell-shaped glides
Dimensions: 20w x 20d x 17.5h
List Price ***360**



OTG13011 - page 141
Rectangular Shaped Modular Ottoman
Snap-in bell-shaped glides
Dimensions: 40.5w x 20d x 17.5h
List Price ***465**



OTG13010 - page 141
V-Shaped Modular Ottoman
Snap-in bell-shaped glides
Dimensions: 43w x 27.5d x 17.5h
List Price ***570**



OTG13007 - page 141
Round Shaped Modular Ottoman
Snap-in bell-shaped glides
Dimensions: 20w x 20d x 17.5h
List Price ***330**



OTG13008 - page 141
Half Round Shaped Modular Ottoman
Snap-in bell-shaped glides
Dimensions: 40w x 21d x 17.5h
List Price ***425**



OTG13009 - page 141
Wedge Shaped Modular Ottoman
Snap-in bell-shaped glides
Dimensions: 40w x 17.75d x 17.5h
List Price ***440**



A Tilt Tension
Increase or decrease to match body weight. Allows you to rock comfortably, reducing muscle fatigue.



B Chair Tilt Lock
Lock the tilt movement in position(s) to accommodate your working posture. Allows you to lock your chair in a comfortable and supportive position. (can be either single position or infinite style).



C Seat Height
Raise or lower to allow your feet to rest flat on the floor. Avoids pressure under your thighs, easing blood flow.



D Back Height
Raise or lower to position lumbar support in your lumbar area. Reduces likelihood of back pain.



E Seat Depth
Change the depth of the seat to accommodate the length of your thighs. Keeps your back in contact with the backrest while avoiding pressure behind your knees.



G Back Angle
Adjust to change the angle of your torso in relation to your thighs. Helps reduce disc pressure and relaxes your back muscles.



H Arm Height
Raise or lower to support your forearms. Reduces muscular effort in neck and shoulders, minimizing risk of pain.



OTG11924 - pages 113, 116, 136, 148
Adjustable Height Arm Kit
Dimensions: 25w x 23d x 43h
List Price ***80**



OTG11620 - pages, 107, 116, 117, 136, 137
Adjustable Height Arm Kit
Dimensions: 25w x 23d x 43h
List Price ***90**



OTG10700
Set of Five Soft Casters
List Price ***50**



OTG10701
Set of Five Soft Casters
List Price ***50**



OTG11600 - pages 107, 116, 117, 136, 137
Drafting Stool Kit with 10" Gas Cylinder

- 26" flat injection molded base
- Twin wheel carpet casters
- 10" gas cylinder
- Height adjustable aluminum foot ring with locking knob
- Casters included
- Soft casters (OTG10700) are available (page 171)
- Available on OTG11922B, OTG11642B, OTG11650 and OTG11343B only

 List Price ***210**



L Synchro-Tilt Movement
Backrest reclines at a faster rate than the seat, increasing the angle between your torso and thighs. Enhances comfort and encourages dynamic body movement.



M Waterfall Seat Edge
Reduces pressure at the back of the knee, contributing to good blood flow.



N Properly Contoured Cushions
Support the body effectively, allowing you to sit longer without discomfort.



Q Width Adjustable Arms
Allows outward movement of armrests to match shoulder breadth. Ensures armrests properly support forearms, reducing muscular effort in neck and shoulders.



R Arm Rotation
Rotate armcap to support your forearm in various positions. Reduces muscular effort in neck and shoulders, minimizing risk of pain.



S Center-Tilt Movement
Chair tilts from a pivot point under the center of the seat allowing you to rock. When your feet are well supported, blood flow is enhanced.



V Lumbar Depth Adjustment
Increase or decrease curvature of the back to match the profile of your lower back. Enhances comfort and support in the lower lumbar area.

OfficestoGo

2DAY SHIP



2DAY
SHIP

MORE
TEXTILES

















Best Selling Seating









Custom Shipped in 2 Days!

In addition to these products being INstock and available now, you can customize and have them shipped in as little as 2 business days (\$55 upcharge applies for non-stocked textiles)!

WORK + TASK

 OTG11650 List Price \$255 Stocked in Quilt QL10 Black (maximum 50)	 OTG11651 List Price \$330 Stocked in Quilt QL10 Black (maximum 50)	 OTG11652 List Price \$355 Stocked in Quilt QL10 Black (maximum 50)
 OTG11686 List Price \$435 Stocked in Black Air Mesh Fabric (maximum 50)	 OTG11692 List Price \$450 Stocked in Luxhide BL20 Black (maximum 50)	 OTG11980 List Price \$515 Stocked in Quilt QL10 Black (maximum 50)
 OTG11685 List Price \$490 Stocked in Black Air Mesh Fabric (maximum 50)	 OTG3191 List Price \$540 Stocked in Luxhide BL20 Black (maximum 50)	 OTG11653 List Price \$565 Stocked in Quilt QL10 Black (maximum 50)
 OTG2801 List Price \$590 Stocked in Black Air Mesh Fabric (maximum 50)	 OTG2803 List Price \$615 Stocked in Black Air Mesh Fabric (maximum 50)	 OTG3101 List Price \$660 Stocked in Luxhide BL20 Black (maximum 50)
 OTG11710 List Price \$660 Stocked in Quilt QL10 Black (maximum 50)	 OTG3103 List Price \$695 Stocked in Black Air Mesh Fabric (maximum 50)	 OTG2913 List Price \$740 Stocked in Luxhide BL20 Black (maximum 50)











CONFERENCE + MANAGEMENT

 OTG2788 List Price \$465 Stocked in Luxhide BL20 Black (maximum 50)	 OTG11734* List Price \$485 Stocked in Luxhide BL20 Black (maximum 50) <i>(See note below)</i>	 OTG11735* List Price \$485 Stocked in Luxhide BL20 Black (maximum 50) <i>(See note below)</i>
 OTG2701 List Price \$505 Stocked in Luxhide BL20 Black (maximum 50)	 OTG11786B List Price \$515 Stocked in Luxhide BL20 Black (maximum 50)	 OTG11730** List Price \$520 Stocked in Luxhide BL20 Black and BL28 White (maximum 50) <i>(See note below)</i>
 OTG11732** List Price \$520 Stocked in Luxhide BL20 Black (maximum 50) <i>(See note below)</i>	 OTG2700 List Price \$525 Stocked in Luxhide BL20 Black (maximum 50)	

*These models (OTG11734 + OTG11735) are only available in the following Luxhide colors in the OTG 2 Day Ship Program: Dark Brown (BL24) and White (BL28). All other textiles and Luxhide colors (except stocked BL20, Black) would be subject to "standard" lead times.

**These models (OTG11730 + OTG11732) are only available in the following Luxhide color in the OTG 2 Day Ship Program: Dark Brown (BL24). All other textiles and Luxhide colors (except stocked BL20, Black (OTG11730 + OTG11732) and BL28, White (OTG11730 only)) would be subject to "standard" lead times.

GUEST + STACK

 OTG11934 List Price \$140 Stocked in Quilt QL10 Black (maximum 100)	 OTG11697 List Price \$170 Stocked in Quilt QL10 Black (maximum 100)	 OTG2748 List Price \$180 Stocked in Quilt QL10 Black (maximum 100)
 OTG11704 List Price \$200 Stocked in Quilt QL10 Black (maximum 100)	 OTG11703 List Price \$225 Stocked in Quilt QL10 Black (maximum 100)	 OTG2782 List Price \$400 Stocked in Luxhide BL20 Black (maximum 50)
 OTG11892 List Price \$340 Stocked in Quilt QL10 Black (maximum 50)	 OTG2809 List Price \$455 Stocked in Black Air Mesh Fabric (maximum 50)	 OTG11340B List Price \$400 Stocked in Black Mesh Fabric (maximum 50)
 OTG11341B List Price \$355 Stocked in Black Mesh Fabric (maximum 50)		



Example of 2 Day Ship Seating Pricing:

Model OTG11980
 List Price..... \$515
 Stocked Textile..... QL10
 Custom Textile (BL26) \$55
Total Cost..... \$570

	+ \$55 =	
OTG11980 (QL10) List Price \$515		OTG11980 (BL26) Total Price \$570

- Offices to Go 2 Day Ship Seating Terms and Conditions**
- All models have **MAXIMUM** order quantities which can be fulfilled within the OTG 2 Day Ship program. These are noted below each model. For greater quantities, please contact CustomerCare for lead times and terms.
 - Orders must clearly state "OTG 2 Day Ship" at the time of submittal.
 - Program is limited to certain Fabrics and Luxhides shown on pages 204-205
 - Orders cannot be changed or canceled after order acknowledgment.
 - Current Offices to Go list price applies at time of order.
 - All eligible models are UPSable; Offices to Go reserves the right to ship "best way."
 - Order must be clean with correct model numbers, options, textiles, correct pricing, etc. to apply.
 - Dealers must be in good standing and within terms for order to be processed without delay.
 - Program available in the 48 contiguous United States.
 - Order shipment address can be to the dealer or end-user directly.



OfficestoGo Superior Laminate Workspace Solutions

- Five contemporary finishes include Autumn Walnut (AWL), American Mahogany (AML), American Dark Cherry (ADC), American Espresso (AEL) + Artisan Grey (AGL) all accented with 3mm matching impact resistant edges.
- Box and file drawers feature full extension ball bearing drawer slides.
- Lateral files and file/file pedestals come equipped with a mechanical safety interlock.
- Pedestals, lateral files + multi-storage files are designed to connect to the appropriate desk, credenza + return shells.
- Metal pins + cam fasteners are designed for easy assembly (where applicable). Metal brackets (where applicable) are also included for additional strength and rigidity.
- Autumn Walnut (AWL), American Espresso (AEL) + Artisan Grey (AGL) are standard with silver handles. Black handles optional (an upcharge applies - see page 192 for more information).
- American Mahogany (AML) + American Dark Cherry (ADC) are standard with black handles. Silver handles optional (an upcharge applies - see page 192 for more information).

Features



Black grommets are standard on desks, returns, bridges, credenzas, extended corners and hutches. Silver grommets optional (an upcharge applies - see page 191 for SLGRSIL).



Top quality full extension ball bearing slides on all box and file drawers.



Black handles standard on AML + ADC. Silver handles optional (an upcharge applies - see page 192 for SLHDSIL).



Silver handles standard on AWL, AEL + AGL. Black handles optional (an upcharge applies - see page 192 for SLHDBLK).

Available immediately in the following finishes:



AWL Autumn Walnut



AML American Mahogany



ADC American Dark Cherry



AEL American Espresso



AGL Artisan Grey

Boardroom Tables

Select Racetrack or Rectangular Tables.
(see pages 198-199 for more information)



Lighting

Your choice of either LED task light or LED desk lamp.
(see page 187 for more information)



Hutch Door Kits

Laminate (pictured) or silver doors with frosted glass options are available.
(see page 191 for more information)



Height Adjustable Tables

Your choice of six table top sizes.
(see page 194-195 for more information)



Frosted Acrylic Dividers

Your choice of three mounting options.
(see page 187 for more information)



Lighting

Your choice of either LED task light or LED desk lamp. (see page 187 for more information)

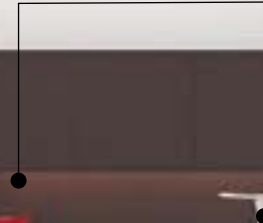

Tables

Square + round tops available in several sizes. X bases stocked in Black or Tungsten.

Modular Ottomans

Six geometric shapes can be configured to create infinite and unique layouts with glides or casters.

Base Options

Pair your Tungsten or Black 15" post legs with several top choices. (see page 199 for more information)

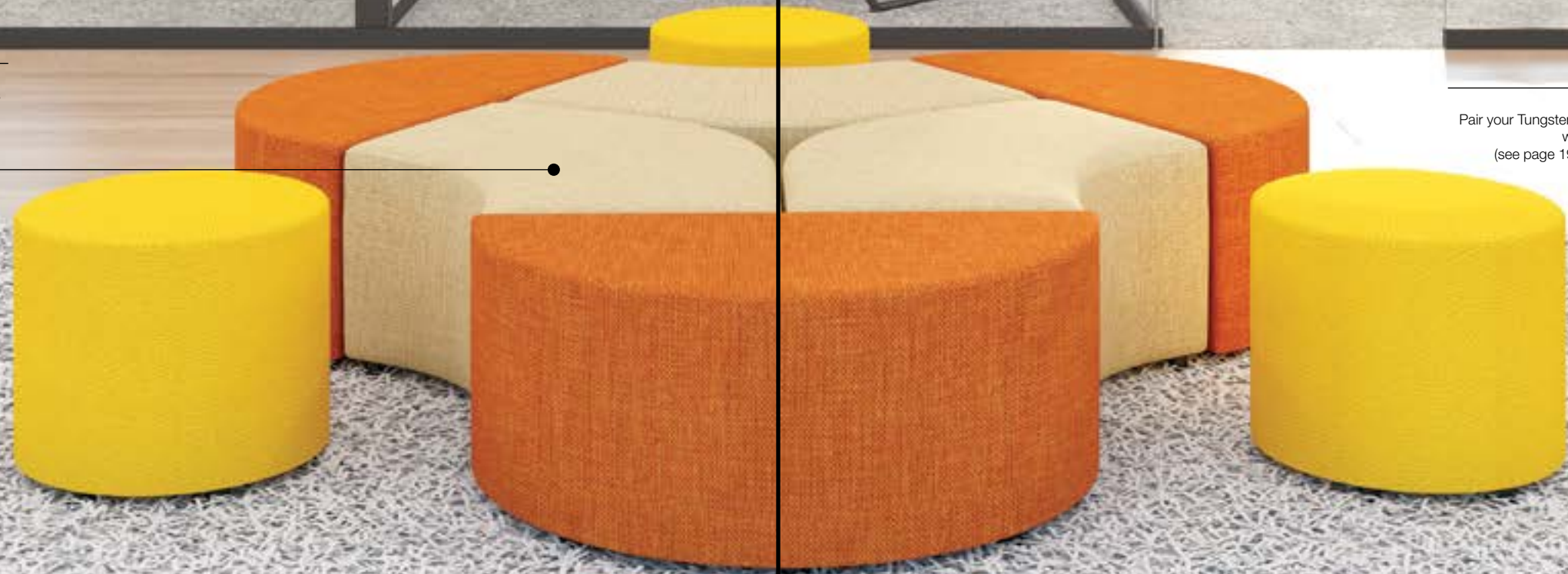

Lighting

Your choice of either LED task light or LED desk lamp.
(see page 187 for more information)

Table Top Bookcase

Specify open (pictured) or select from laminate or silver doors with frosted glass.
(see page 191 for more information)

Hutch Door Kits

Your choice of either laminate (pictured) or silver doors with frosted glass.
(see page 191 for more information)

Tables

Square + round tops available in several sizes.
X bases stocked in Black or Tungsten.

Handle Options

Black handles standard on AML + ADC.
Silver handles optional at an upcharge.
Silver handles standard on AWL, AEL + AGL.
Black handles optional at an upcharge.
(see page 192 for more information)

Height Adjustable Tables

Your choice six table top sizes.
(see page 194-195 for more information)





Productivity Solutions



SL20CD
20" Center Drawer
List Price ***124**



SLKB
Keyboard Tray
22.625w x 3d x .6875
List Price ***81**



OTGPCLP1
Shared Surface Edge
Mount Clamp to fit
SLAP48, SLAP60 +
SLAP71
Mounting screws included
List Price ***54** per pair



OTGPCLP2
Edge Mount Clamp to
fit SLAP48, SLAP60 +
SLAP71
Mounting screws included
List Price ***48** per pair



OTGPCLP3
Surface Mount Clamp to
fit SLAP48, SLAP60 +
SLAP71
Mounting screws included
List Price ***32** per pair



SLAP48
Acrylic Panel for 48"
Worksurface
42.5w x 12.5h x .25d
List Price ***157**
2 individual clamps required
per panel



SLAP60
Acrylic Panel for 60"
Worksurface
54.5w x 12.5h x .25d
List Price ***252**
3 individual clamps required
per panel



SLAP71
Acrylic Panel for 71"
Worksurface
66.5w x 12.5h x .25d
List Price ***324**
3 individual clamps required
per panel

Power Solutions



OTGGRSIN-SIL
Grommet with Single
Duplex Power in Silver
Fits all OTG grommets
List Price ***76**



OTGGRSIN-BLK
Grommet with Single
Duplex Power in Black
Fits all OTG grommets
List Price ***76**



OTGGRUSB-SIL
Grommet with 2 USB
Power Outlets in Silver
Fits all OTG grommets
List Price ***152**



OTGGRUSB-BLK
Grommet with 2 USB
Power Outlets in Black
Fits all OTG grommets
List Price ***152**



OTGLEDLAMP
LED Desk Lamp
List Price ***151**



OTGLEDL31
31" LED Task Light
All installation hardware
included
List Price ***151**



LAYOUT SL-1		
Model	Description	List Price
SL6030TOP	60" x 30" Rectangular Laminate Top	\$165
SLSB60T	Support Bar	\$41
OTGSTL28	28"H Metal Square Table Leg (#66 each)	\$264
SLAP60	60" Acrylic Panel	\$252
OTGPCLP3	Surface Mount Clamp - Pair	\$32
SL22BFM	22" Mobile Box/File Pedestal with Lock	\$420
Total		\$1174



LAYOUT SL-4		
Model	Description	List Price
SL7124TOP	71" x 24" Rectangular Laminate Top	\$163
SL4824TOP	48" x 24" Rectangular Laminate Top	\$118
SLSB71T	Support Bar	\$50
OTGSTL28	28"H Metal Square Table Leg (#66 each)	\$264
OTGHABASE2	Height Adjustable Table Base	\$700
SLAP71	71" Acrylic Panel	\$324
OTGPCLP3	Surface Mount Clamp - Pair	\$32
SL22BFM	22" Mobile Box/File Pedestal with Lock	\$420
Total		\$2071



LAYOUT SL-7		
Model	Description	List Price
SL6630DS	66" Rectangular Desk Shell	\$331
SL22BBF	22" Box/Box/File Pedestal with Lock	\$360
SL4824TOP	48" x 24" Rectangular Laminate Top	\$118
OTGHABASE2	Height Adjustable Table Base	\$700
SL22BFM	22" Mobile Box/File Pedestal with Lock	\$420
Total		\$1929



LAYOUT SL-10		
Model	Description	List Price
SL6024TOP	60" x 24" Rectangular Laminate Top (#139 each)	\$556
OTGFTBASE60	60" Flip Top Training Table Base (#389 each)	\$1556
OTG11341B	Mesh Back Flip Seat Nesting Chair (#355 each)	\$2840
Total		\$4952



LAYOUT SL-2		
Model	Description	List Price
SL7130TOP	71" x 30" Rectangular Laminate Top	\$194
SLSB71T	Support Bar	\$50
OTGSTL28	28"H Metal Square Table Leg (#66 each)	\$264
OTGPCLP3	Surface Mount Clamp - Pair (#32 each)	\$64
SLAP71	71" Acrylic Panel	\$324
SL22BFM	22" Mobile Box/File Pedestal with Lock (#420 each)	\$840
SL22BBF	22" Box/Box/File Pedestal with Lock	\$360
SL22FF	22" File/File Pedestal with Lock	\$360
SL7124CS	71" Credenza Shell	\$331
SL71HO	71" Open Hutch	\$395
SL71SIDR	Glazed Doors with Silver Frame	\$351
Total		\$3533



LAYOUT SL-5		
Model	Description	List Price
SL4830TOP	48" x 30" Rectangular Laminate Top (#139 each)	\$556
SLSB48T	Support Bar (#33 each)	\$132
OTGSTL28	28"H Metal Square Table Leg (#66 each)	\$660
SLAP48	48" Acrylic Panel (#157 each)	\$314
OTGPCLP1	Shared Surface Edge Mount Clamp - Pair (#54 each)	\$108
SL22BFM	22" Mobile Box/File Pedestal with Lock (#420 each)	\$1680
Total		\$3450



LAYOUT SL-8		
Model	Description	List Price
SL4824TOP	48" x 24" Rectangular Laminate Top (#118 each)	\$472
OTGHABASE2	Height Adjustable Table Base (#700 each)	\$2800
SLAP48	48" Acrylic Panel (#157 each)	\$628
OTGPCLP2	Edge Mount Clamp - Pair (#48 each)	\$192
SL22BFM	22" Mobile Box/File Pedestal with Lock (#420 each)	\$1680
Total		\$5772



LAYOUT SL-11		
Model	Description	List Price
SL14448RECS	144" x 48" Rectangular Conference Table	\$1388
SL3622SC	Storage Cabinet with Lock	\$419
SL3622LF	Lateral File with Lock	\$574
SL7122TOP	Common Top	\$110
SL71BC	71" Bookcase (#398 each)	\$796
SL4848VB	Presentation Board	\$706
Total		\$3993



LAYOUT SL-3		
Model	Description	List Price
SL7130TOP	71" x 30" Rectangular Laminate Top	\$194
SLSB71T	Support Bar	\$50
OTGSTL28	28"H Metal Square Table Leg (#66 each)	\$264
OTGPCLP3	Surface Mount Clamp - Pair (#32 each)	\$64
SLAP71	71" Acrylic Panel	\$324
SL7124CS	71" Credenza Shell	\$331
SL4824TOP	48" Laminate Top	\$118
OTGHABASE2	Height Adjustable Table Base	\$700
SL22BFM	22" Mobile Box/File Pedestal with Lock	\$420
SL22BBF	22" Box/Box/File Pedestal with Lock	\$360
SL71HO	71" Open Hutch	\$395
SL71SIDR	Glazed Doors with Silver Frame	\$351
Total		\$3571



LAYOUT SL-6		
Model	Description	List Price
SL7124CS	71" x 24" Credenza Shell (#331 each)	\$662
SL4824TOP	48" x 24" Rectangular Laminate Top (#118 each)	\$236
SLSB48T	Support Bar (#33 each)	\$66
OTGSTL28	28"H Metal Square Table Leg (#66 each)	\$396
SLAP48	48" Acrylic Panel (#157 each)	\$314
SLAP71	71" Acrylic Panel 2 individual clamps required per panel	\$324
OTGPCLP3	Surface Mount Clamp - Pair (#32 each)	\$128
OTGM393	Flat Bracket (#40 each)	\$80
SL22BFM	22" Mobile Box/File Pedestal with Lock (#420 each)	\$840
SL22FF	22" File/File Pedestal with Lock (#360 each)	\$720
Total		\$3766



LAYOUT SL-9		
Model	Description	List Price
SL6024TOP	60" x 24" Rectangular Laminate Top (#139 each)	\$556
SLSB60T	Support Bar (#41 each)	\$164
OTGSTL28	28"H Metal Square Table Leg (#66 each)	\$1056
OTGSTL4CSTR	Casters - Set of Four (#40 each)	\$160
OTG11341B	Mesh Back Flip Seat Nesting Chair (#355 each)	\$1420
Total		\$3356



LAYOUT SL-12		
Model	Description	List Price
SL9644HT	96" x 44" x 41" High Top Collaboration Table	\$1362
SL3622MSF	Mixed Storage Unit with Lock	\$562
SL3622SC	Storage Cabinet with Lock	\$419
SL7122TOP	Common Top	\$110
SL48BC	48"H Bookcase (#271 each)	\$542
SL71HO	71" Open Hutch	\$395
Total		\$3390

DESKS + WORKSTATIONS



SL7141BDS
Bow Front Desk Shell
71w x 36/42d x 29.5h
List Price ***398**



SL7136DS
71" Rectangular Desk Shell
71w x 36d x 29.5h
List Price ***355**



SL7130DS
71" Rectangular Desk Shell
71w x 30d x 29.5h
List Price ***355**

NEW



SL6630DS
66" Rectangular Desk Shell
66w x 30d x 29.5h
List Price ***331**



SL6030DS
60" Rectangular Desk Shell
60w x 30d x 29.5h
List Price ***301**



SL4830DS
48" Rectangular Desk Shell
48w x 30d x 29.5h
List Price ***288**



SL4824DS
48" Rectangular Desk Shell
48w x 24d x 29.5h
List Price ***286**



SL7148BCL
Bow Front with Corner Extension - LEFT - Not Freestanding
72w x 30/36/48d x 29.5h
List Price ***518**



SL7148BCR
Bow Front with Corner Extension - RIGHT - Not Freestanding
72w x 30/36/48d x 29.5h
List Price ***518**



SL4824R
48" Return Shell - REVERSIBLE
48w x 24d x 29.5h
List Price ***221**



SL4820R
48" Return Shell - REVERSIBLE
48w x 20d x 29.5h
List Price ***221**

NEW



SL4224R
42" Return Shell - REVERSIBLE
42w x 24d x 29.5h
List Price ***221**



SL4220R
42" Return Shell - REVERSIBLE
42w x 20d x 29.5h
List Price ***221**

NEW



SL3624R
36" Return Shell - REVERSIBLE
36w x 24d x 29.5h
List Price ***184**



SL3024R
30" Return Shell - REVERSIBLE
30w x 24d x 29.5h
List Price ***178**



SL7124CS
71" Credenza Shell
71w x 24d x 29.5h
List Price ***331**



SL6624CS
66" Credenza Shell
66w x 24d x 29.5h
List Price ***309**



SL6024CS
60" Credenza Shell
60w x 24d x 29.5h
List Price ***309**

NEW



SL7136DI
"D" Island - Full End Panel + Post (T-Base) - Not Freestanding
71w x 36d x 29.5h
List Price ***364**



SL7136CEL
Credenza with Corner Extension - LEFT - Not Freestanding
71w x 24/36d x 29.5h
List Price ***410**



SL7136CER
Credenza with Corner Extension - RIGHT - Not Freestanding
71w x 24/36d x 29.5h
List Price ***410**



SL71HO
71" Overhead Hutch - OPEN
71w x 15d x 36h
List Price ***395**

NEW



SL71HD
71" Overhead Hutch with Doors
71w x 15d x 36h
List Price ***464**
Limited availability. Check with your local representative.

NEW



SL66HO
66" Overhead Hutch - OPEN
66w x 15d x 36h
List Price ***383**
Fits SL6630DS and SL6624CS only



SL66HD
66" Overhead Hutch with Doors
66w x 15d x 36h
List Price ***440**
Fits SL6630DS and SL6624CS only
Limited availability. Check with your local representative.



SL60HO
60" Overhead Hutch - OPEN
60w x 15d x 36h
List Price ***365**

NEW



SL48HO
48" Overhead Hutch - OPEN
48w x 15d x 36h
List Price ***337**

NEW



SL42425C
5 Sided Corner
42w x 42d x 29.5h
List Price ***356**



SL36WC
36" Wall-Mounted Cabinet
36w x 15d x 17h
List Price ***256**



SL4824FB
48" Flush Bridge
48w x 24d x 29.5h
List Price ***178**



SL4224FB
42" Flush Bridge
42w x 24d x 29.5h
List Price ***178**



SL3624FB
36" Flush Bridge
36w x 24d x 29.5h
List Price ***156**



SL3024FB
30" Flush Bridge
30w x 24d x 29.5h
List Price ***146**



SL12G
Half End Panel
12w x 1d x 28h
List Price ***50**



SL7130RDS
71" Reception Desk Shell - LAMINATE TOP - Riser pins not included. 71w x 30d x 42h
List Price ***574**
Limited availability. Check with your local representative.



SL7130RDSNT
71" Reception Desk Shell - NO TOP - Must be ordered with Transaction Top
71w x 30d x 42h
List Price ***465**

NEW



SL7130RDFGT
71" Reception Transaction Top - FROSTED GLASS
List Price ***383**

NEW



SL7130RDLT
71" Reception Transaction Top - LAMINATE - Includes riser pins
List Price ***125**

NEW



SL4224RR
42" Reception Return - REVERSIBLE
42w x 24d x 41h
List Price ***288**

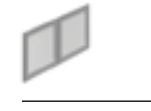

SL36SIDR
Silver Doors for SL36HO + SL36WC
List Price ***189**

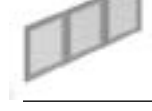

SL48SIDR
Silver Doors for SL48HO
List Price ***219**

NEW

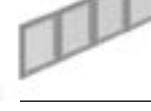

SL60SIDR
Silver Doors for SL60HO
List Price ***279**

NEW

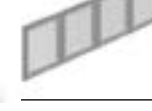

SL66SIDR
Silver Doors for SL66HD + SL66HO
List Price ***334**

NEW

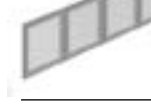

SL71SIDR
Silver Doors for SL71HD + SL71HO
List Price ***351**



SL48LDR
Laminate Doors for SL48HO
List Price ***89**

NEW



SL60LDR
Laminate Doors for SL60HO
List Price ***95**

NEW



SL66LDR
Laminate Doors for SL66HO
List Price ***96**

NEW



SL71LDR
Laminate Doors for SL71HO
List Price ***100**

NEW



SLGRBLK
Black Grommet Cover
List Price ***5**



SLGRBLK10
Black Grommet Cover - 10 Pack
List Price ***34**



SLGRSIL
Silver Grommet Cover
List Price ***5**



SLGRSIL10
Silver Grommet Cover - 10 Pack
List Price ***34**

DESKING ACCESSORIES



SL20CD
20" Center Drawer
List Price ***124**



SLKB
Keyboard Tray
22.625w x 3d x .6875
List Price ***81**



SL71TB
71" Tackboard - Black Fabric - To be used with SL71HD + SL71HO
68.25w x 17.25h
List Price ***117**



SL66TB
66" Tackboard - Black Fabric - To be used with SL66HD + SL66HO
64w x 17.25h
List Price ***111**



OTGPCLP1
Shared Surface Edge Mount Clamp to fit SLAP48, SLAP60 + SLAP71 - Pair
Mounting screws included
List Price ***54** per pair

NEW



OTGPCLP2
Edge Mount Clamp to fit SLAP48, SLAP60 + SLAP71 - Pair
Mounting screws included
List Price ***48** per pair

NEW



OTGPCLP3
Surface Mount Clamp to fit SLAP48, SLAP60 + SLAP71 - Pair
Mounting screws included
List Price ***32** per pair

NEW



SLAP48
Acrylic Panel for 48" Worksurface
42.5w x 12.5h x .25d
List Price ***157**
2 individual clamps required per panel

NEW



SLAP60
Acrylic Panel for 60" Worksurface
54.5w x 12.5h x .25d
List Price ***252**
3 individual clamps required per panel

NEW



SLAP71
Acrylic Panel for 71" Worksurface
66.5w x 12.5h x .25d
List Price ***324**
3 individual clamps required per panel

NEW



SLSB48T
48" Stiffener Bar for use with corresponding rectangular top when using with OTGSL28 + OTGSL15
List Price ***33**

NEW



SLSB60T
60" Stiffener Bar for use with corresponding rectangular top when using with OTGSL28 + OTGSL15
List Price ***41**

NEW



SLSB71T
71" Stiffener Bar for use with corresponding rectangular top when using with OTGSL28 + OTGSL15
List Price ***50**

NEW



OTGM393
1 Flat Bracket. Used as a mending plate to give additional work surface support. Mounting screws included.
List Price ***40**

NEW

POWER SOLUTIONS



NEW

OTGGRSIN-SIL
Grommet with Single Duplex Power in Silver
Fits all OTG standard grommets, except SL7130DS / SL6630DS / SL6030DS / SL4830DS
List Price **\$76**



NEW

OTGGRSIN-BLK
Grommet with Single Duplex Power in Black
Fits all OTG standard grommets, except SL7130DS / SL6630DS / SL6030DS / SL4830DS
List Price **\$76**



NEW

OTGGRUSB-SIL
Grommet with 2 USB Power Outlets in Silver
Fits all OTG standard grommets, except SL7130DS / SL6630DS / SL6030DS / SL4830DS
List Price **\$152**



NEW

OTGGRUSB-BLK
Grommet with 2 USB Power Outlets in Black
Fits all OTG standard grommets, except SL7130DS / SL6630DS / SL6030DS / SL4830DS
List Price **\$152**



NEW

OTGLEDTL31
31" LED Task Light
All installation hardware included
List Price **\$151**



NEW

OTGLEDLAMP
LED Desk Lamp
List Price **\$151**

BOOKCASES



SL36HO
36" Table Top Bookcase
36w x 15d x 36h
List Price **\$291**



SL71BC
71" 4 Shelf Bookcase with one fixed shelf and three adjustable shelves
32w x 14d x 71h
List Price **\$398**



SL48BC
48" 2 Shelf Bookcase with two adjustable shelves
32w x 14d x 48h
List Price **\$271**



SL30BC
30" 1 Shelf Bookcase with one adjustable shelf
32w x 14d x 30h
List Price **\$211**

STORAGE OPTIONS



SL22BBF
22"D Box/File Pedestal with Lock
16w x 22d x 28h
List Price **\$360**



SL22FF
22"D File/Box/File Pedestal with Lock
16w x 22d x 28h
List Price **\$360**



SL22BBFM
22"D Mobile Box/File Pedestal with Lock
Not for use with OTGSTL28 + OTGSLBxT
16w x 22d x 28.5h
List Price **\$522**



SL22BFFM
22"D Mobile Box/File Pedestal with Lock
16w x 22d x 19h
List Price **\$420**



SL22TOP
Top for SL22BBF + SL22FF
List Price **\$47**



SL22HBF
22"D Hanging Box/File Pedestal with Lock
16w x 22d x 19h
List Price **\$256**



NEW

SL19HBF
19"D Hanging Box/File Pedestal with Lock
16w x 19d x 19h
List Price **\$256**
Fits SL4220R and SL4820R only



SL3622LF
2 Drawer Lateral File with Lock
36w x 22d x 29.5h
List Price **\$574**



SLCWT
Counterweight for use with SL3622LF
List Price **\$50**



SL3622SC
36" Storage Cabinet with Lock
36w x 22d x 29.5h
List Price **\$419**



SL3622MSF
36" Mixed Storage Unit with Lock
36w x 22d x 29.5h
List Price **\$562**



SL7122TOP
Common Top for use across any combination of SL3622LF, SL3622SC + SL3622MSF
List Price **\$110**



SLHDSIL
Silver Handle
List Price **\$14**



SLHDSIL10
Silver Handle - 10 Pack
List Price **\$101**



SLHDBLK
Black Handle
List Price **\$14**



SLHDBLK10
Black Handle - 10 Pack
List Price **\$101**

COLLABORATION TABLES



NEW

SL9644HT
96" High Top Collaboration Table
96w x 44d x 41h
List Price **\$1362**



SL36R
36" Round Table with Cross Base
36w x 29.5h
List Price **\$220**



SL42R
42" Round Table with Cross Base
42w x 29.5h
List Price **\$309**



SL48R
48" Round Table with Cross Base
48w x 29.5h
List Price **\$355**

CONFERENCE TABLES



NEW

SL14448RECS
144" Rectangular Conference Table with Slab Base - Top is standard in 2 pieces - 1 3/8" Top
144w x 48d x 29.5h
List Price **\$1388**



NEW

SL12048RECS
120" Rectangular Conference Table with Slab Base - Top is standard in 2 pieces - 1 3/8" Top
120w x 48d x 29.5h
List Price **\$1156**



NEW

SL9644RECS
96" Rectangular Conference Table with Slab Base - 1 3/8" Top
96w x 44d x 29.5h
List Price **\$806**



NEW

SL7142RECS
71" Rectangular Conference Table with Slab Base - 1 3/8" Top
71w x 42d x 29.5h
List Price **\$621**



SL12048RS
120" Racetrack Conference Table with Slab Base - Top is standard in 2 pieces - 1 3/8" Top
120w x 48d x 29.5h
List Price **\$814**



SL9544RS
95" Racetrack Conference Table with Slab Base - 1 3/8" Top
95w x 44d x 29.5h
List Price **\$551**



SL7136RS
71" Racetrack Conference Table with Slab Base - 1 3/8" Top
71w x 36d x 29.5h
List Price **\$440**



SL4848VB
Presentation Board - Tackable Black Fabric on Doors
48w x 48h
List Price **\$706**

MEETING TABLE TOPS + BASES



NEW

SL24SQTOP
24" Square Laminate Top
24w x 24d
List Price **\$87**



NEW

SL36SQTOP
36" Square Laminate Top
36w x 36d
List Price **\$160**



NEW

SL42SQTOP
42" Square Laminate Top
42w x 42d
List Price **\$195**



NEW

SL48SQTOP
48" Square Laminate Top
48w x 48d
List Price **\$239**



NEW

SL36RDTOP
36" Round Laminate Top
List Price **\$160**



NEW

SL42RDTOP
42" Round Laminate Top
List Price **\$195**



NEW

SL48RDTOP
48" Round Laminate Top
List Price **\$239**



SL4824TOP
48" Rectangular Laminate Top
48w x 24d x 1h
Does not include mounting screws
List Price **\$118**



SL6024TOP
60" Rectangular Laminate Top
60w x 24d x 1h
Does not include mounting screws
List Price **\$139**



NEW

SL7124TOP
71" Rectangular Laminate Top
71w x 24d x 1h
Does not include mounting screws
List Price **\$163**



SL4830TOP
48" Rectangular Laminate Top
48w x 30d x 1h
Does not include mounting screws
List Price **\$139**



SL6030TOP
60" Rectangular Laminate Top
60w x 30d x 1h
Does not include mounting screws
List Price **\$165**



SL7130TOP
71" Rectangular Laminate Top
71w x 30d x 1h
Does not include mounting screws
List Price **\$194**



NEW

OTGXTB3642
Metal "X" Base to Fit SL36RDTOP, SL42RDTOP, SL36SQTOP + SL42SQTOP - Black or Tungsten - Top mounting screws included
List Price **\$256**



NEW

OTGSTL28
28"H Metal Square Post Table Leg - Black or Tungsten - Top mounting screws included
27.95h (standard adjustable glides)
29.65h (optional casters)
List Price **\$325**



NEW

OTGSTL28
28"H Metal Square Post Table Leg - Black or Tungsten - Top mounting screws included
27.95h (standard adjustable glides)
29.65h (optional casters)
List Price **\$66**



NEW

OTGSTL15
15"H Metal Square Post Table Leg - Black or Tungsten - Top mounting screws included
15.15h (standard adjustable glides)
16.85h (optional casters)
List Price **\$43**



NEW

OTGSTL1CSTR
Caster for OTGSTL28 + OTGSTL15
List Price **\$12**



NEW

OTGSTL4CSTR
Casters for OTGSTL28 + OTGSTL15 (4 pack)
List Price **\$40**



Height Adjustable Tables

Height Adjustable Table Base



NEW

OTGHABASE2-TUN
Height Adjustable Table Base
Top mounting screws included
List Price **\$700**

FEATURES

- Steel construction with Tungsten finish
- Digital display, 3 programmable positions
- Height adjustment range of 27.8" - 45.5" (includes standard Offices to Go worksurface top)
- Accommodates 24" and 30" depths
- Adjustable to accommodate 48" - 72" widths
- Height adjustment speed of 1" per second
- Single motor
- 2 Legs, dual stage
- Lifting capacity: 220 lbs.
- Power consumption (while active): 115W
- Power consumption (in standby): 0.5W
- Horizontal worksurface support crossbar includes markings to make setting width easy
- Leg Diameter: 2.35" x 2.35"
- Foot Length: 23.25"
- Anti-collision safety feature

Layout Shown in American Mahogany (AML)

Model	Description	List Price
OTGHABASE2-TUN	Height adjustable table base (\$700 each)	\$2800
SL6024TOP	60" Rectangular Laminate Top (\$139 each)	\$556
SLAP60	Acrylic Panel for 60" Worksurface (\$252 each)	\$1008
OTGPCLP3	Surface Mount Clip to fit SLAP60 - Pair (\$32 each)	\$128
SL22BFM	22"D Mobile Box/File Pedestal with Lock (\$420 each)	\$1680
SLHDSIL	Silver Handle (\$14 each)	\$140
OTGLEDLAMP	LED Desk Lamp (\$151 each)	\$453
Total		\$6765

Seating shown



OTG11647B
(page 107)

Components shown



OTGHABASE2-TUN



SL6024TOP



SL22BFM



OTGLEDLAMP



SLHDSIL



OTGPCLP3



SLAP60

Accessories shown

Laminate Table Tops*



SL4824TOP

Rectangular Laminate Top
Dimensions: 48w x 24d x 1h
List Price **\$118**

SL6024TOP

Rectangular Laminate Top
Dimensions: 60w x 24d x 1h
List Price **\$139**

SL7124TOP

Rectangular Laminate Top
Dimensions: 71w x 24d x 1h
List Price **\$163**

SL4830TOP

Rectangular Laminate Top
Dimensions: 48w x 30d x 1h
List Price **\$139**

SL6030TOP

Rectangular Laminate Top
Dimensions: 60w x 30d x 1h
List Price **\$165**

SL7130TOP

Rectangular Laminate Top
Dimensions: 71w x 30d x 1h
List Price **\$194**

Laminate Table Tops Available immediately in the following finishes:



AWL Autumn Walnut



AML American Mahogany



ADC American Dark Cherry



AEL American Espresso



AGL Artisan Grey

*Screws not included with tops



Flip Top Training Tables

Flip Top Training Table Bases



NEW

OTGFTBASE48
48" Flip Top Training Table Base
List Price ***\$373**

OTGFTBASE60
60" Flip Top Training Table Base
List Price ***\$389**

OTGFTBASE71
71" Flip Top Training Table Base
List Price ***\$406**

FEATURES

- Single lever activates flip top / nesting mechanism
- Accommodates 24" & 30" deep tops
- Equipped with 4 locking casters
- Modesty panel included
- Black (BLK) or Tungsten (TUN) finishes available
- Table top mounting screws included with base

Layout Shown in Artisan Grey (AGL)

Model	Description	List Price
OTGFTBASE60	Height adjustable table base	*\$389
SL6024TOP	60" Rectangular Laminate Top	*\$139
Total		*\$528

Components shown



OTGFTBASE60



SL6024TOP

Seating shown



OTG11341B
(page 150)



OTG13050B
(page 146)

Laminate Table Tops*



SL4824TOP

Rectangular Laminate Top
Dimensions: 48w x 24d x 1h
List Price ***\$118**

SL6024TOP

Rectangular Laminate Top
Dimensions: 60w x 24d x 1h
List Price ***\$139**

SL7124TOP

Rectangular Laminate Top
Dimensions: 71w x 24d x 1h
List Price ***\$163**

SL4830TOP

Rectangular Laminate Top
Dimensions: 48w x 30d x 1h
List Price ***\$139**

SL6030TOP

Rectangular Laminate Top
Dimensions: 60w x 30d x 1h
List Price ***\$165**

SL7130TOP

Rectangular Laminate Top
Dimensions: 71w x 30d x 1h
List Price ***\$194**

Laminate Table Tops Available immediately in the following finishes:



AWL Autumn Walnut



AML American Mahogany



ADC American Dark Cherry



AEL American Espresso



AGL Artisan Grey

*Screws not included with tops



Conference + Meeting Tables

Square Meeting Table Tops

NEW

			
SL24SQTOP 24" Square Laminate Top 24w x 24d List Price *87	SL36SQTOP 36" Square Laminate Top 36w x 36d List Price *160	SL42SQTOP 42" Square Laminate Top 42w x 42d List Price *195	SL48SQTOP 48" Square Laminate Top 48w x 48d List Price *239

Round Meeting Table Tops

NEW

		
SL36RDTOP 36" Round Laminate Top List Price *160	SL42RDTOP 42" Round Laminate Top List Price *195	SL48RDTOP 48" Round Laminate Top List Price *239

Rectangular Top Conference Tables

NEW

			
SL14448RECS 144" Rectangular Conference Table with Slab Base - Top is standard in 2 pieces - 1 3/8" Top List Price *1388	SL12048RECS 120" Rectangular Conference Table with Slab Base - Top is standard in 2 pieces - 1 3/8" Top List Price *1156	SL9644RECS 96" Rectangular Conference Table with Slab Base - 1 3/8" Top List Price *806	SL7142RECS 71" Rectangular Conference Table with Slab Base - 1 3/8" Top List Price *621

Racetrack Top Conference Tables

		
SL12048RS 120" Racetrack Conference Table with Slab Base - Top is standard in 2 pieces - 1 3/8" Top List Price *814	SL9544RS 95" Racetrack Conference Table with Slab Base - 1 3/8" Top List Price *551	SL7136RS 71" Racetrack Conference Table with Slab Base - 1 3/8" Top List Price *440

Round Meeting Tables with Cross Base





		
SL36R 36" Round Table with Cross Base List Price *220	SL42R 42" Round Table with Cross Base List Price *309	SL48R 48" Round Table with Cross Base List Price *355

Rectangular Meeting Table Tops*

					
SL4824TOP 48" Rectangular Laminate Top List Price *118	SL6024TOP 60" Rectangular Laminate Top List Price *139	SL7124TOP 71" Rectangular Laminate Top List Price *163	SL4830TOP 48" Rectangular Laminate Top List Price *139	SL6030TOP 60" Rectangular Laminate Top List Price *165	SL7130TOP 71" Rectangular Laminate Top List Price *194

Metal Bases**

NEW

			
OTGXTB3642 Metal "X" Base to Fit SL36RDTOP, SL42RDTOP, SL36SQTOP + SL42SQTOP - Black or Tungsten - Top mounting screws included List Price *256	OTGXTB48 Metal "X" Base to Fit SL48RDTOP + SL48SQTOP - Black or Tungsten - Top mounting screws included List Price *325	OTGSTL28 28"H Metal Square Post Table Leg - Black or Tungsten - Top mounting screws included 27.95h (standard adjustable glides) 29.65h (optional casters) List Price *66	OTGSTL15 15"H Metal Square Post Table Leg - Black or Tungsten - Top mounting screws included 15.15h (standard adjustable glides) 16.85h (optional casters) List Price *43

Accessory

NEW

OTGM393 1 Flat Bracket. Used as a mending plate to give additional worksurface support. Mounting screws included. List Price *40

Available immediately in the following finishes:



*Screws not included with tops
**Mounting screws for tops included with base



Collaboration Table



NEW

SL9644HT

96" High Top Collaboration Table

Dimensions: 96w x 44d x 41h

List Price ***1362**

Suggested seating applications:



OTG11343B with OTG11600 Stool Kit (page 171)



OTG11650B with OTG11600 Stool Kit (page 171)



OTG11642B with OTG11600 Stool Kit (page 171)



OTG11922B with OTG11600 Stool Kit (page 171) - pictured left

Available immediately in the following finishes:



AWL Autumn Walnut



AML American Mahogany



ADC American Dark Cherry



AEL American Espresso



AGL Artisan Grey

quick ship textiles



QUILT - Grade 1 100% Polyester
Available on GLOBAL and Offices to Go seating.



JENNY - Grade 1 100% Polyester
Available on GLOBAL and Offices to Go seating.



FUSION - Grade 1 90% Virgin Polyester, 10% Post Consumer Recycled Polyester
Available on GLOBAL and Offices to Go seating.



NEW TEXTILE

ILLUSION - Grade 1 100% Virgin Polyester
Available on GLOBAL and Offices to Go seating.



TERRACE - Grade 1 70% Virgin Polyester / 30% Post-Consumer Recycled Polyester
Available on GLOBAL and Offices to Go seating.



CARRERA - Grade 1 100% Olefin
Available on GLOBAL and Offices to Go seating.



WATERFALL - Grade 1 60% Virgin Polyester / 40% Post-Consumer Recycled Polyester
Available on GLOBAL and Offices to Go seating.



NEW TEXTILE

WAVELENGTH - Grade 1 100% Virgin Polyester
Available on GLOBAL and Offices to Go seating.



URBAN - Grade 1 62% Recycled Polyester / 32% Polyester
Available on GLOBAL and Offices to Go seating.

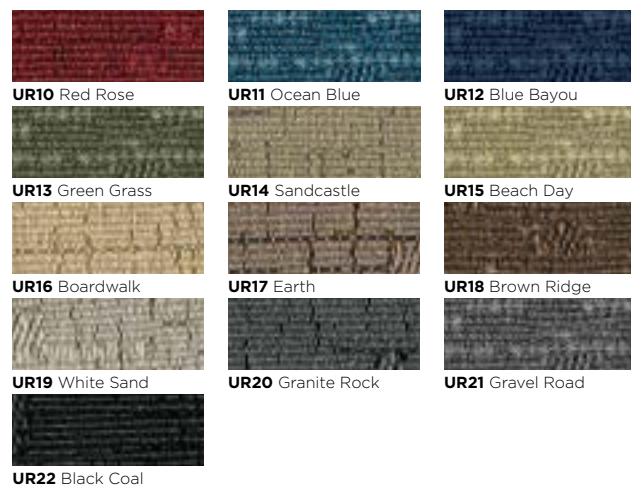

HUDSON - Grade 1 100% Post Consumer Recycled Polyester
Available on GLOBAL and Offices to Go seating.



ELEVATE - Grade 2 80% Post-Consumer Recycled Polyester / 20% Rayon
Available on GLOBAL seating only.



IMPRINT - Grade 2 100% Post-Consumer Recycled Polyester / Stain Repellent Finish
Available on GLOBAL seating only.



MATCH - Grade 2 100% Recycled Polyester
Available on GLOBAL seating only.



SILHOUETTE - Grade 2 100% Nylon / Stain Repellent Finish
Available on GLOBAL seating only.



REPLAY - Grade 2 100% Post-Consumer Recycled Polyester / Stain Repellent Finish
Available on GLOBAL seating only.



ETCH - Grade 2 80% Post-Consumer Recycled Polyester / 20% Rayon
Available on GLOBAL seating only.



COUTURE - Grade 2 100% Post-Consumer Recycled Polyester
Available on GLOBAL seating only.



GC LINEN - Grade 2 100% Vinyl
Available on GLOBAL seating only.



NEW TEXTILE

ALLANTE FREE - Grade 2 100% Vinyl (Face) / 100% Polyester (Back)
Available on GLOBAL and Offices to Go seating.



LEATHER/MOCK LEATHER - Grade 5 100% Leather / 100% Polyvinyl Chloride
Available on GLOBAL seating only.



GENUINE LEATHER - Grade 8 100% Leather
Available on GLOBAL seating only.



RELEASE - Grade 2 100% Vinyl
Available on GLOBAL seating only.



LUXHIDE Luxhide is a bonded leather consisting of 15% leather fibers
Available on Offices to Go seating only.



GLOBAL SEATING

Arno	
4003.....	32
4004.....	32
Aspen	
2851-3*.....	12
2852-3.....	12
Bakhita	
6750.....	38
6751.....	38
6754.....	38
6756.....	38
Citi	
7875*.....	35
7876*.....	34-35
7877*.....	35
7885*.....	35
Concorde	
2424-18*.....	33
Height Adjustable Stool Kit	
2241.....	31
2243.....	31
Duet	
6620*.....	45
6621.....	45
6624.....	45
Factor	
5440.....	5, 6-7
5541.....	6-7
File Buddy	
1105.....	91
Flap	
XXX.....	39
G1 Ergo Select	
7331.....	14, 72-73
7332.....	4, 14, 74-75
Global Accord	
2670-4.....	26
2671-4.....	26
Goal	
2236-6.....	31
2237-3.....	22
2237-5.....	22
2237-6.....	22
2239-6.....	22, 76-77
Graham	
3144.....	23

Granada	
3212.....	15
3217.....	15
Graphic	
2738MB.....	20
Loover	
2661-8.....	18
2662-8.....	18
Luray	
6461.....	27
6462.....	27
Popcorn	
6710*.....	43
6711*.....	43
6715.....	43
6716.....	43
Roma	
1906.....	19, 79
1899.....	19, 41
Sidero	
6900.....	42
6901.....	42
Solar	
8456.....	29
8457.....	25, 28, 29, 84-85
Sonic	
6508.....	44
6513.....	44
Spyker	
6790*.....	39
6791.....	39
6756.....	39
Spritz	
6765C.....	36-37, 40
Synopsis	
5080-3*.....	13
5081-3*.....	13
5090-4.....	30
5091-4.....	30
Truform	
5450-3.....	16
5451-3.....	16
5450-8.....	16
5451-8.....	16
TS5450-3.....	17
TS5451-3.....	17
S5458-6.....	17, 31

Tye	
1950-4.....	21
1951-4.....	21

Vion Fog	
6321-0-OFAFG.....	11
6322-0-OFAFG.....	10-11
6325FO.....	11

Vion	
6321-4(C).....	9
6321-8.....	9
6322-8.....	9

GLOBAL WORKSPACE + MEETING AREAS

Bakhita Tables.....	38, 83
Boardroom Tables.....	84-85
Foli Height Adjustable Tables.....	31, 80-81, 83
Genoa Desking.....	72-79
Intelli Beam.....	80-81
Lite Lift II Tables.....	85
Swap Tables.....	82
Zira Desking.....	64-71

GLOBAL FILING + STORAGE

1900 Series Pedestals.....	91
1900 Plus Lateral Files.....	90
2500 Vertical Files.....	91
9300 Plus Lateral Files.....	90
File Buddy 1105.....	91
Storage Cabinets.....	91

OFFICES TO GO SEATING

GC3010.....	153
OTG10700.....	171
OTG10701.....	171
OTG1220B.....	155
OTG1221B.....	155
OTG2700.....	123
OTG2701.....	123
OTG2748.....	153
OTG2782.....	123, 145
OTG2788.....	126
OTG2801.....	98-99
OTG2803.....	99
OTG2809.....	144
OTG2821.....	99
OTG2913.....	96
OTG3101.....	97
OTG3103.....	97
OTG3191.....	100
OTG3915B.....	149
OTG3918B.....	147
OTG10900B.....	133
OTG10901B.....	132
OTG10902B.....	133
OTG10904B.....	110
OTG11300B.....	121
OTG11310B.....	154
OTG11311B.....	154
OTG11312.....	154
OTG11313.....	154
OTG11320B.....	114
OTG11325B.....	100
OTG11328B.....	111
OTG11340B*.....	150
OTG11341B.....	150
OTG11343B.....	117
OTG11512B.....	144
OTG11514B.....	108
OTG11516B.....	108
OTG11600.....	107, 116, 117, 136, 137
OTG11620.....	107, 116, 117, 136, 137
OTG11612B.....	115
OTG11617B.....	130
OTG11618B.....	121
OTG11631B.....	111
OTG11641B.....	107
OTG11642B.....	107, 116
OTG11647B.....	107
OTG11648B.....	120
OTG11650.....	117
OTG11651.....	105
OTG11652.....	105
OTG11653.....	104
OTG11657B.....	127
OTG11685B.....	103
OTG11686B.....	103
OTG11692.....	101
OTG11697.....	152
OTG11698.....	152
OTG11700.....	155
OTG11701.....	153
OTG11703.....	152
OTG11704.....	152
OTG11705.....	153
OTG11706.....	152
OTG11710.....	96
OTG11715B.....	114
OTG11730B.....	125
OTG11732.....	125
OTG11734B.....	125
OTG11735.....	125
OTG11740B.....	147
OTG11750B.....	132
OTG11760B.....	151
OTG11761B.....	151
OTG11769B.....	108
OTG11770B(CX).....	149
OTG11770B(ES).....	149
OTG11776B.....	131
OTG11782B.....	131
OTG11786B.....	129
OTG11790B.....	126
OTG11820B(CX).....	145
OTG11820B(TH).....	145
OTG11850B.....	115
OTG11858B.....	120
OTG11865B.....	109
OTG11892.....	150
OTG11920B.....	113, 148
OTG11921B.....	113, 148
OTG11922B.....	113, 116, 148
OTG11923B.....	113, 148
OTG11924.....	113, 116, 136, 148
OTG11934.....	153
OTG11950B.....	110
OTG11975B.....	130
OTG11980B.....	101
OTG12110B.....	104
OTG12112B.....	109
OTG13007.....	141
OTG13008.....	141
OTG13009.....	141
OTG13010.....	141
OTG13011.....	141
OTG13012.....	141
OTG13026B.....	135
OTG13050B.....	135, 146
OTG13050BT.....	135, 146
OTG5001NA*.....	139
OTG5002.....	139
OTG5002C.....	139
OTG5003.....	139
OTG5004.....	139
OTG5011.....	139

OTG13010.....	141
OTG13011.....	141
OTG13012.....	141
OTG13026B.....	135
OTG13050B.....	135, 146
OTG13050BT.....	135, 146
OTG5001NA*.....	139
OTG5002.....	139
OTG5002C.....	139
OTG5003.....	139
OTG5004.....	139
OTG5011.....	139

OFFICES TO GO WORKSPACE SOLUTIONS

Collaboration Tables.....	200-201
Conference + Meeting Tables.....	127, 198-199
Flip Top Training Tables.....	196-197
Height Adjustable Tables.....	194-195
Superior Laminate Workspace Solutions.....	176-193

*Not UPSable

All Global dimensions are shown in inches. Prices shown are current manufacturer's suggested list price at the time of printing.

All applicable taxes are extra. Descriptions, specifications and prices are subject to change without notice.

Errors and omissions are subject to correction. Color samples depicted in this book are as close to actual as modern printing processes will allow.

All Offices To Go dimensions are nominal. Prices shown are current manufacturer's suggested list price at the time of printing.

All applicable taxes are extra. Descriptions, specifications and prices are subject to change without notice.

Errors and omissions are subject to correction. Color samples depicted in this book are as close to actual as modern printing processes will allow.

National Stocking + 2 Day Ship Express Programs



OfficestoGo



globalfurnituregroup.com
OfficestoGo.com

Effective April 2020

Updated 061521