



PLEASE REFER TO THE
ONLINE EXPRESS PDF
FOR CURRENT PRICING AND
PRODUCT AVAILABILITY

Globalfurnituregroup.com/resources/literature
Officestogo.com/resources/brochures



GLOBAL + OFFICES TO GO JANUARY 2022

express

Global Product Navigation

GLOBAL SEATING

Arno	4003
.....	4004
Aspen	2851-3
.....	2852-3
Bakhita	6750
.....	6751
.....	6754
.....	6783
Citi	7875
.....	7876
.....	7877
.....	7885
Concorde	2424-18
Stool Kit	2241
.....	2243
Duet	6620
.....	6621
.....	6624
Factor	5540
.....	5541
File Buddy	1105
G1 Ergo Select	7331
.....	7332
Global Accord	2670-4
.....	2671-4

Goal	2236-6
.....	2237-3
.....	2237-5
.....	2237-6
.....	2239-6
Graham	3144
Granada	3212
.....	3217
Graphic	2738MB
Loover	2661-8
.....	2662-8
Luray	6461
.....	6462
Popcorn	6710
.....	6711
.....	6715
.....	6716
Roma	1906
.....	1899
Sidero	6900
.....	6901
Solar	8456
.....	8457
Sonic	6508
.....	6513

Spyker	6790
.....	6791
.....	6756
Spritz	6765C
Synopsis	5080-3
.....	5081-3
.....	5090-4
.....	5091-4
Truform	5450-3
.....	5451-3
.....	5450-8
.....	5451-8
.....	TS5450-3
.....	TS5451-3
.....	S5458-6
Tye	1950-4
.....	1951-4
Vion Fog	6321-0-OFAFG
.....	6322-0-OFAFG
.....	6325FO
Vion	6321-4(C)
.....	6321-8
.....	6322-8

[SEATING AT A GLANCE](#)



GLOBAL WORKSPACE + MEETING AREAS

- [Bakhita Tables](#)
- [Boardroom Tables](#)
- [Foli Height Adjustable Tables](#)
- [Genoa Desking](#)
- [Intelli Beam](#)
- [Lite Lift II Tables](#)
- [Swap Tables](#)
- [Zira Desking](#)

GLOBAL FILING + STORAGE

- [1900 Series Pedestals](#)
- [1900 Plus Lateral Files](#)
- [2500 Vertical Files](#)
- [9300 Plus Lateral Files](#)
- [File Buddy 1105](#)
- [Storage Cabinets](#)

OTG Product Navigation

WORK + TASK

OTG2801	OTG2803
OTG2821	OTG2913
OTG3101	OTG3103
OTG3191	OTG10904B
OTG11320B	OTG11325B
OTG11328B	OTG11343B
OTG11514B	OTG11516B
OTG11612B	OTG11631B
OTG11641B	OTG11642B
OTG11647B	OTG11650
OTG11651	OTG11652
OTG11653	OTG11685B
OTG11686B	OTG11692
OTG11710	OTG11715B
OTG11769B	OTG11850B
OTG11865B	OTG11920B
OTG11921B	OTG11922B
OTG11950B	OTG11980B
OTG12110B	OTG12112B
CONFERENCE + MANAGEMENT	
OTG2700	OTG2701
OTG2788	OTG10900B
OTG10901B	OTG10902B
OTG11300B	OTG11617B
OTG11618B	OTG11648B
OTG11657B	OTG11730B

OTG11732	OTG11734B
OTG11735	OTG11750B
OTG11776B	OTG11782B
OTG11786B	OTG11790B
OTG13026B	OTG11858B
OTG11975B	

STACK, NESTING + GUEST

GC3010	OTG1220B
OTG1221B	OTG2748
OTG2782	OTG2809
OTG3915B	OTG3918B
OTG11310B	OTG11311B
OTG11312	OTG11313
OTG11340B	OTG11341B
OTG11512B	OTG11697
OTG11698	OTG11700
OTG11701	OTG11703
OTG11704	OTG11705
OTG11706	OTG11740B
OTG11760B	OTG11761B
OTG11770BCX	OTG11770BES
OTG11892	OTG11820BCX
OTG11820BTH	OTG11923B
OTG11934	OTG13050B
OTG13050BT	

LOUNGE

OTG5001NA	OTG5002
OTG5002C	OTG5003
OTG5004	OTG5011
OTG13007	OTG13008
OTG13009	OTG13010
OTG13011	OTG13012

ACCESSORIES

OTG10700	OTG10701
OTG11600	OTG11620
OTG11924	

[SEATING AT A GLANCE](#)



OFFICES TO GO WORKSPACE SOLUTIONS

- [Collaboration Tables](#)
- [Conference + Meeting Tables](#)
- [Flip Top Training Tables](#)
- [Height Adjustable Tables](#)
- [Superior Laminate Workspace Solutions](#)

Think Global. Think Green.

The Environment — We believe now more than ever, that it is our responsibility to protect the environment and our precious natural resources for future generations. The growing importance of energy and environmental concerns continues to challenge us in this ever changing marketplace.

As an industry leader, Global continues to take proactive steps towards reducing the negative impacts on the environment. We are building “healthier” offices; investing in Research & Development and new technologies; reducing waste and the consumption of energy; and improving the quality of the air we breathe, all which can have a significant impact on our quality of life.

Global's recycled fabrics offer affordable, environmentally responsible alternatives to commercial textiles. We recycle 35,000 lbs. of fabric off cuts.

Epoxy powder coating process is solvent free. No harmful VOC's or lead. No toxins are released into the atmosphere.

Global has the products and resources to help your projects achieve LEED certification.

New technology allows us to reduce glue usage by 50%. In addition, our water based glue reduces emissions and requires less energy to apply.



Greenguard Certification

The GREENGUARD mark means that a product has been tested using stringent environmental chamber methods and found to meet GREENGUARD's Indoor Air Quality Standards. GREENGUARD Certified Products are low emitting and contribute minimal levels of pollutants to indoor environment.



Level Certification

level™ certification, based on the ANSI/BIFMA e3-2012 furniture sustainability standard, sets furniture manufacturers on a path toward greater sustainability over time. Based on environmental and social criteria set forth in the standard, a product's entire supply chain is assessed.



What's covered under the Global Lifetime Warranty?



Global's Lifetime Warranty covers manufacturer defects for seating, desks, tables, panels, metal storage and filing... everything you would need in a contract work environment covered for the life of the product.

NO WORRIES on plastic components, casters, glides, pneumatic cylinders, arm structures, arm caps and bases

NO WORRIES on drawer slides, trays, locks, keys, metal legs and grommets.

NO WORRIES on panel frames, edges and work surfaces.

For complete details, visit www.globalfurnituregroup.com.

What's covered under the Offices to Go® 5 Year Warranty?



Offices To Go® warrants its products to be free from defects in material and workmanship subject to the limitations below.

Under this warranty, claims must be made within the following periods from the original date of purchase: (a) non-moving parts are warranted for five years; (b) drawers, slides, leveling glides, locks, and other moving parts are warranted for two years; (c) gas cylinders, mechanisms, and other moving parts are warranted for two years; (d) upholstery materials and foam are warranted for two years.

Desking and Tables warranty is based on an eight hour, single shift workday. Seating warranty is based on an eight hour, single shift work day for users weighing up to 250 pounds. NOTE: Select light duty stacking chairs; OTG11696, and OTG11697, are warranted for users weighing up to 200 pounds.

Height adjustable bases (OTGHABASE2) electric motors, controllers and moving parts are warranted for 5 years. Height adjustable base warranty is based on an eight hour, single shift work day and maximum lifting capacity of 220lbs.

For complete details, visit www.OfficestoGo.com.

Symbols + Identification

2DAY LIGHTNING

SHIPS FROM THE FACTORY IN 2 DAYS!

When you see this symbol, the adjacent **GLOBAL** product is suitable for 2 Day shipment.



When you see these symbols, the adjacent **OFFICES TO GO** product is suitable for 2 Day shipment.



All seating product shown throughout this catalog is suitable for UPS shipment **unless otherwise noted**.



Why wait when you can have it all now?

Inside, you will find numerous workplace furniture solutions — seating, desks, files, tables and accessories — all at different price points — **and all available for quick delivery!**

Contents

GLOBAL

Seating Solutions

Work + Task Solutions	4-23
Conference + Management Solutions.....	24-33
Lounge + Reception Solutions.....	34-35
Stack, Nesting + Guest Solutions.....	36-45
Seating at a Glance	46-55
2 Day Lightning	56-61

Workspace + Meeting Areas Solutions

Zira.....	64-71
Genoa.....	72-79
Intelli Beam.....	80-81
Foli Height Adjustable Tables.....	80-81, 83
Swap Tables	82
Bakhita Tables	83
Boardroom Tables.....	84-85
Lite Lift II Table.....	85
Workstations at a Glance.....	86-87

Filing + Storage Solutions

1900 Plus Lateral	90
9300 Plus Lateral	90
2500 Vertical	91
1900 Series Pedestal	91
File Buddy.....	91
Storage Cabinets.....	91

OFFICES TO GO

Seating Solutions

Work + Task Solutions	94-117
Conference + Management Solutions.....	118-135
Drafting Solutions	136-137
Lounge + Reception Solutions.....	138-141
Stack, Nesting + Guest Solutions.....	142-155
Seating at a Glance	156-171
2 Day Ship	172-175

Workspace Solutions

Superior Laminate Workspace Solutions	176-193
Productivity Solutions.....	186-187
Power Solutions	186-187
Height Adjustable Tables.....	194-195
Flip Top Training Tables.....	196-197
Conference + Meeting Tables	198-199
Collaboration Table	200-201

REFERENCE

Green Story	Inside Front Cover
Global Warranty	Inside Front Cover
Offices to Go Warranty	Inside Front Cover
Symbols + Identification.....	Inside Front Cover
Quick Ship Textiles + Finishes	202-207

global furniture group



global

Citi 7876 (page 35) Two Seat Sofa and 7875 (page 35) Lounge Chair shown in Leather/Mock Leather, Black (550/450) and Tungsten (TUN) legs.

work + task



G1 Ergo Select 7332 (page 14) High Back Weight Sensing Synchro-Tilter shown in Waterfall, Dance (WA54).



Factor 5540-8 (page 6) Mesh High Back Weight Sensing Synchro-Tilter shown in Fusion, Granite (FU77) and Cloud (IC) frame.

All seating is nationally stocked and available immediately or part of the 2DAY LIGHTNING program and ships within two business days.



Factor 5540
 Mesh High Back Weight Sensing Synchro-Tilter with seat slider (-8), Height Adjustable arms (U2)
 List Price **\$706**
 Shown in Fusion, Granite (FU77) with Black Frame (BK) and Black Mesh (P-6)



Factor 5540 - LIMITED QTY AVAILABLE
 Mesh High Back Weight Sensing Synchro-Tilter with seat slider (-8), Height Adjustable arms (U2)
 List Price **\$754**
 Shown in Fusion, Granite (FU77) with Shadow Frame (SH) and Black Mesh (P-6)



Factor 5540 - LIMITED QTY AVAILABLE
 Mesh High Back Weight Sensing Synchro-Tilter with seat slider (-8), Height Adjustable arms (U2)
 List Price **\$754**
 Shown in Fusion, Granite (FU77) with Cloud Frame (IC) and Black Mesh (P-6)



Factor 5541
 Mesh Mid Back Weight Sensing Synchro-Tilter with seat slider (-8), Height Adjustable arms (U2)
 List Price **\$674**
 Shown in Fusion, Carbon (FU85) with Black Frame (BK) and Black Mesh (P-6)



Factor 5541 - LIMITED QTY AVAILABLE
 Mesh Mid Back Weight Sensing Synchro-Tilter with seat slider (-8), Height Adjustable arms (U2)
 List Price **\$722**
 Shown in Fusion, Carbon (FU85) with Shadow Frame (SH) and Black Mesh (P-6)



Factor 5541 - LIMITED QTY AVAILABLE
 Mesh Mid Back Weight Sensing Synchro-Tilter with seat slider (-8), Height Adjustable arms (U2)
 List Price **\$722**
 Shown in Fusion, Carbon (FU85) with Cloud Frame (IC) and Black Mesh (P-6)

Available immediately in the following textiles:



FU85 Carbon

FU77 Granite

P-6 Black

Highlighted models are being phased out of the Express Program. Please inquire for availability.

For specifications and dimensions see pages 46-47.

Factor™

Factor seating series recalculates the value equation for work chairs with an asymmetrical lumbar support, weight sensing synchro mechanism and adjustable arms.



Mid and high backrests are upholstered in a breathable mesh offering continuous support

Durable, lightweight frame

Height adjustable and split down the middle to flex independently side-to-side

Adjustable lumbar support provides personalized comfort and is standard on all models

Height adjustable arms (U2)

2DAY LIGHTNING
 SHIPS FROM THE FACTORY IN 2 DAYS!



Factor 5440-8 Mesh High Back Weight Sensing Synchro-Tilter, Height Adjustable Arms (U2).
 Shown in Fusion, Aqua (FU75).
 For available textiles, see pages 202-207.

Factor 2DAY LIGHTNING models are available in Black mesh + frame only.

MODEL	DESCRIPTION	LIST PRICE (starting at)
5540.....	High Back Weight Synchro-Tilter with U2 arms and Seat Slider Mechanism	\$706
5541.....	Mid Back Weight Synchro-Tilter with U2 arms and Seat Slider Mechanism	\$674

Vion™

Vion is no ordinary office chair. Designed by Zooley Chu, Vion's unique back provides exceptional comfort throughout the workday.

Mid and high backrests are upholstered in a breathable mesh offering continuous support

Durable, lightweight frame (Black finish)

Height adjustable and split down the middle to flex independently side-to-side

Adjustable lumbar support provides personalized comfort and is standard on all models



Vion 6321-8
Mesh High Back Weight Sensing Synchro-Tilter - Black frame
List Price **\$871**
Shown in Urban, Black Coal (UR22)



Vion 6322-8
Mesh Medium Back Weight Sensing Synchro-Tilter - Black frame
List Price **\$825**
Shown in Urban, Black Coal (UR22)

Vion 6321-4(C) - LIMITED QTY AVAILABLE
Mesh High Back Tilter with Fixed (C) Arms - Black frame
List Price **\$779**
Shown in Urban, Black Coal (UR22)

Highlighted models are being phased out of the Express Program. Please inquire for availability.
For specifications and dimensions see page 47.

Available immediately in the following textiles:



2DAY LIGHTNING

SHIPS FROM THE FACTORY IN 2 DAYS!



Vion 6321-8 Mesh High Back Weight Sensing Synchro-Tilter
Shown in Vion Mesh Blue (MS72) with Jenny Cascade (JN28) seat and optional Polished Aluminum base (FA).
For available textiles, see pages 202-207.

Vion 2DAY LIGHTNING models are available in five Vion Mesh colors:



Model pricing below includes Black frame

MODEL	DESCRIPTION	LIST PRICE (starting at)
6321-0	High Back Synchro-Tilter	\$871
6321-3	High Back Multi-Tilter	\$871
6321-4	High Back Tilter	\$779
6321-8	High Back Weight Sensing Synchro-Tilter	\$871
6322-0	Medium Back Synchro-Tilter	\$825
6322-3	Medium Back Multi-Tilter	\$825
6322-4	Medium Back Tilter	\$733
6322-8	Medium Back Weight Sensing Synchro-Tilter	\$825
TS6321-3	High Back Multi-Tilter (Heavy Duty)	\$1129
TS6322-3	Medium Back Multi-Tilter (Heavy Duty)	\$1084
6324*	Armless Low Back Side Chair	\$546
6324C*	Armless Low Back Side Chair with casters	\$610
6325*	Low Back Armchair	\$585
6325C*	Low Back Armchair with casters	\$648
6327-6	Armless Medium Back Task Stool	\$747
6328-6	Medium Back Task Stool	\$843
6331-0	Upholstered High Back Synchro-Tilter	\$987
6331-3	Upholstered High Back Multi-Tilter	\$987
6331-4	Upholstered High Back Tilter	\$883
6331-8	Uph. High Back Weight Sensing Synchro-Tilter	\$987
6332-0	Upholstered Medium Back Synchro-Tilter	\$942
6332-3	Upholstered Medium Back Multi-Tilter	\$942
6332-4	Upholstered Medium Back Tilter	\$843
6332-8	Uph. Medium Back Weight Sensing Synchro-Tilter	\$942
6335*	Upholstered Low Back Armchair	\$637

*Not UPSable

TS stands for "Three Shift" and each of the TS models are rated for 24-7 applications as well as weight rated up to 350 pounds.

Vion™ Fog

The Vion family is not only design savvy with its Fog frame finish, but is adaptable to any office or meeting room environment.

Vion Fog 6322-0FAFG
 Mesh Medium Back Synchro-Tilter with Back Angle Adjustment - Fog frame
 List Price **\$788**
 Shown in Fusion, Graphite (FU81)



Vion Fog 6321-0FAFG - LIMITED QTY AVAILABLE
 Mesh High Back Synchro-Tilter with Back Angle Adjustment - Fog frame
 List Price **\$828**
 Shown in Fusion, Graphite (FU81)



Vion Fog 6322-0FAFG - LIMITED QTY AVAILABLE
 Mesh Medium Back Synchro-Tilter with Back Angle Adjustment - Fog frame
 List Price **\$788**
 Shown in Fusion, Graphite (FU81)

Vion Fog 6325FO - FU85 LIMITED QTY AVAILABLE
 Mesh Side Chair - Fog frame and back
 List Price **\$575**
 Shown in Fusion, Graphite (FU81)

Highlighted models are being phased out of the Express Program. Please inquire for availability.

For specifications and dimensions see pages 47-48.

Available immediately in the following textiles:

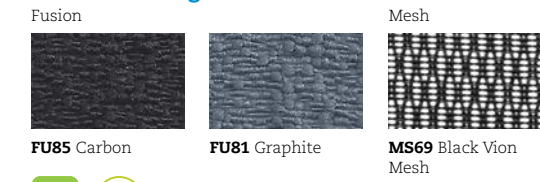

2DAY LIGHTNING

SHIPS FROM THE FACTORY IN 2 DAYS!



Vion Fog 6321-8FAFG Mesh High Back Weight Sensing Synchro-Tilter
 Shown in Vion Mesh Natural (MS74) with Fusion, Tangerine (FU71) seat and Fog base.
 For available textiles, see pages 202-207.

Vion Fog 2DAY LIGHTNING models are available in five Vion Mesh colors:



Model pricing below includes Fog frame

MODEL	DESCRIPTION	LIST PRICE (starting at)
6321-0FAFG	High Back Synchro-Tilter	\$828
6321-3FAFG...	High Back Multi-Tilter	\$828
6321-4FAFG...	High Back Tilter	\$747
6321-8FAFG...	High Back Weight Sensing Synchro-Tilter	\$828
6322-0FAFG...	Medium Back Synchro-Tilter	\$788
6322-3FAFG...	Medium Back Multi-Tilter	\$788
6322-4FAFG...	Medium Back Tilter	\$706
6322-8FAFG...	Medium Back Weight Sensing Synchro-Tilter	\$788
TS6321-3FAFG	High Back Multi-Tilter (Heavy Duty)	\$1057
TS6322-3FAFG	Medium Back Multi-Tilter (Heavy Duty)	\$1017
6324FO*	Armless Low Back Side Chair	\$483
6324CFO*	Armless Low Back Side Chair with casters	\$539
6325FO*	Low Back Armchair	\$575
6325CFO*	Low Back Armchair with casters	\$573
6327-6FAFG...	Armless Medium Back Task Stool	\$719
6328-6FAFG...	Medium Back Task Stool	\$804
6331-0FAFG	Upholstered High Back Synchro-Tilter	\$931
6331-3FAFG...	Upholstered High Back Multi-Tilter	\$931
6331-4FAFG...	Upholstered High Back Tilter	\$838
6331-8FAFG...	Uph. High Back Weight Sensing Synchro-Tilter	\$931
6332-0FAFG...	Upholstered Medium Back Synchro-Tilter	\$891
6332-3FAFG...	Upholstered Medium Back Multi-Tilter	\$891
6332-4FAFG...	Upholstered Medium Back Tilter	\$804
6332-8FAFG...	Uph. Medium Back Weight Sensing Synchro-Tilter	\$891
6335FO*	Upholstered Low Back Armchair	\$563

*Not UPSable

TS stands for "Three Shift" and each of the TS models are rated for 24-7 applications as well as weight rated up to 350 pounds.

Aspen™

Aspen is a fully-featured task chair that delivers superior ergonomics, affordability and contemporary styling.



Aspen 2851-3* LIMITED QTY AVAILABLE
 High Back Multi-Tilter
 List Price ***1193**
 Shown in Jenny, Charcoal (JN11)



Aspen 2852-3 LIMITED QTY AVAILABLE
 Medium Back Multi-Tilter
 List Price ***1158**
 Shown in Jenny, Charcoal (JN11)

Available immediately in the following textile:



JN11 Charcoal



Synopsis®

A family of products with exceptional value and a transitional design defines Synopsis.



Synopsis 5080-3* LIMITED QTY AVAILABLE
 High Back Multi-Tilter
 List Price ***1050**
 Shown in Urban, Granite Rock (UR20)



Synopsis 5081-3* LIMITED QTY AVAILABLE
 Medium Back Multi-Tilter
 List Price ***950**
 Shown in Urban, Granite Rock (UR20)

Synopsis 5081-3* LIMITED QTY AVAILABLE
 Medium Back Multi-Tilter
 List Price ***950**
 Shown in Urban, Black Coal (UR22)

Available immediately in the following textiles:



UR20 Granite Rock



UR22 Black Coal



2DAY LIGHTNING
 SHIPS FROM THE FACTORY IN 2 DAYS!



Synopsis 5081-3* Medium Back Multi-Tilter
 Shown in Silhouette, Verdant (SL24).
 For available textiles, see pages 202-207.

MODEL	DESCRIPTION	LIST PRICE (starting at)
5080-0	High Back Synchro-Tilter	\$1050
5081-0	Medium Back Synchro-Tilter	\$950
5080-3*	High Back Multi-Tilter	\$1050
5081-3*	Medium Back Multi-Tilter	\$950
5090-4	High Back Tilter	\$656
5091-4	Medium Back Tilter	\$615

*Not UPSable

For additional Synopsis models see page 30.

For specifications and dimensions see page 49.

G1 Ergo Select™

G1 Ergo Select is expertly designed to fit the human body. Sit, move and work comfortably.



G1 Ergo Select 7332 - LIMITED QTY AVAILABLE
 High Back Weight Sensing Synchro-Tilter (-8), standard seat size and Height + Width Adjustable arms (G5)
 List Price ***1194**
 Shown in Waterfall, Dance (WA54)

G1 Ergo Select 7331 - LIMITED QTY AVAILABLE
 Medium Back Weight Sensing Synchro-Tilter (-8), standard seat size and Height + Width Adjustable arms (G5)
 List Price ***1132**
 Shown in Waterfall, Dance (WA54)

Features



Lumbar Adjustment



Armrests Slide Forward and Backward



Standard Matching Thread Stitch



Armrests Pivot Inwards and Outwards 25° and Slide Inwards and Outwards

Available immediately in the following textile:

Waterfall



WA54 Dance



For specifications and dimensions see page 30.

Granada®

Granada, the ideal, full-function, cost-effective computer chair.



Granada 3217 - LIMITED QTY AVAILABLE
 High Back Multi-Tilter
 List Price ***1006**
 Shown in Waterfall, Grand (WA50)

Granada 3212 - LIMITED QTY AVAILABLE
 Low Back Multi-Tilter
 List Price ***895**
 Shown in Waterfall, Dance (WA54)

Mechanism



Multi-Tilter



Height Adjustable Arms



Seat Slider (MD)



Back Height

Available immediately in the following textiles:

Waterfall



WA50 Grand



WA54 Dance



For specifications and dimensions see page 49.

Truform®

Truform is available with a wide range of mechanisms including synchro-tilters, knee-tilters, multi-tilters, tilters, operators, task chairs, drafting stools (with task mechanisms) and multi-tilters for heavy duty applications (TS models).



Truform 5450-3
High Back Multi-Tilter
List Price **\$842**
Shown in Jenny, Ebony (JN02)



Truform 5451-8 - LIMITED QTY AVAILABLE
Medium Back Weight Sensing Synchro-Tilter
List Price **\$807**
Shown in Jenny, Ebony (JN02)



Truform 5451-3
Medium Back Multi-Tilter
List Price **\$807**
Shown in Jenny, Ebony (JN02)



Truform 5450-8
High Back Weight Sensing Synchro-Tilter
List Price **\$842**
Shown in Jenny, Ebony (JN02)

Available immediately in the following textile:



JN02 Ebony



For specifications and dimensions see page 48.

2DAY LIGHTNING
SHIPS FROM THE FACTORY IN 2 DAYS!



Truform TS TS5450-3
High Back Multi-Tilter Heavy Duty
List Price **\$988**
Shown in Jenny, Ebony (JN02)



Truform TS TS5451-3
Medium Back Multi-Tilter Heavy Duty
List Price **\$954**
Shown in Jenny, Ebony (JN02)

Truform TS S5458-6 - LIMITED QTY AVAILABLE
Medium Back Heavy Duty Drafting Stool
List Price **\$1172**
Shown in Jenny, Ebony (JN02)



Truform TS5450-8 High Back Heavy Duty Weight Sensing Synchro-Tilter
Shown in Jenny, Ebony (JN02).
For available textiles, see pages 202-207.

MODEL	DESCRIPTION	LIST PRICE (starting at)
5450-0	High Back Synchro-Tilter	\$842
5450-3	High Back Multi-Tilter	\$842
5450-4	High Back Tilter	\$749
5450-8	High Back Weight Sensing Synchro-Tilter	\$842
5451-0	Medium Back Synchro-Tilter	\$807
5451-3	Medium Back Multi-Tilter	\$807
5451-4	Medium Back Tilter	\$715
5451-8	Medium Back Weight Sensing Synchro-Tilter	\$807
5457-6	Medium Back Drafting Stool (Armless)	\$959
5458-6	Medium Back Drafting Stool	\$1120
S5457-6	Medium Back Drafting Stool (Heavy Duty) (Armless)	\$1011
S5458-6	Medium Back Drafting Stool (Heavy Duty)	\$1172
TS5450-3	High Back Multi-Tilter (Heavy Duty)	\$988
TS5451-3	Medium Back Multi-Tilter (Heavy Duty)	\$954

TS stands for "Three Shift" and each of the TS models are rated for 24-7 applications as well as weight rated up to 350 pounds.

For specifications and dimensions see pages 48-49.

2DAY LIGHTNING
SHIPS FROM THE FACTORY IN 2 DAYS!



Loover 2661-8 High Back Weight Sensing Synchro-Tilter
Shown in Match, Sand (MT21) with Vue Mesh, Sandy Beach (VU10).
For available textiles, see pages 202-207.

Loover 2DAY LIGHTNING models are available in five Vue Mesh colors:



MODEL	DESCRIPTION	LIST PRICE (starting at)
2661-0	High Back Synchro-Tilter	\$944
2661-3	High Back Multi-Tilter	\$944
2661-4	High Back Tilter	\$829
2661-8	High Back Weight Sensing Synchro-Tilter	\$944
2662-0	Medium Back Synchro-Tilter	\$902
2662-3	Medium Back Multi-Tilter	\$902
2662-4	Medium Back Tilter	\$802
2662-8	Medium Back Weight Sensing Synchro-Tilter	\$902

For specifications and dimensions see page 49.

Loover™

Loover features an open back frame upholstered with Vue mesh for individual comfort.



Loover 2662-8
Mesh Medium Back Weight Sensing Synchro-Tilter
List Price **\$902**
Shown in Urban, Black Coal (UR22) with Vue Mesh, Coal Black (VU19)



Loover 2661-8
Mesh High Back Weight Sensing Synchro-Tilter
List Price **\$944**
Shown in Urban, Granite Rock (UR20) with Vue Mesh, Coal Black (VU19)

Available immediately in the following textiles:



Roma™

Roma fits the bill without taking up too much space.



Roma 1906 - LIMITED QTY AVAILABLE
Mesh Medium Back Task
List Price **\$831**
Shown in Urban, Black Coal (UR22) with Black Mesh



Roma 1899
Mesh Back Nesting Armchair
List Price **\$674**
Shown in Urban, Black Coal (UR22) with Black Mesh

Available immediately in the following textile:

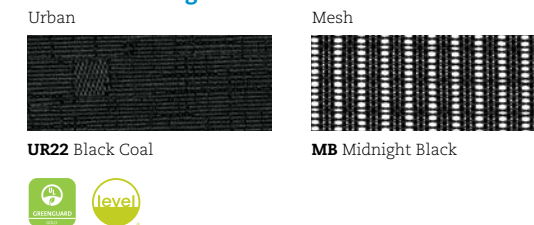

2DAY LIGHTNING
SHIPS FROM THE FACTORY IN 2 DAYS!



Roma 1906 Mesh Medium Back Task
Shown in Etch, Drift (ET81).
For available textiles, see pages 202-207.
Roma 2DAY LIGHTNING models are available in Black mesh only.

MODEL	DESCRIPTION	LIST PRICE (starting at)
1901	Medium Posture Back (Armless)	\$778
1906	Medium Back Task	\$831
1906RA	Medium Back Task (Height Adjustable Arms)	\$761
1890	Plastic Back Nesting Armchair	\$621
1899	Nesting Armchair	\$674

For specifications and dimensions see pages 49, 55.

2DAY LIGHTNING
SHIPS FROM THE FACTORY IN 2 DAYS!



Graphic 2738MB Mesh Medium Back Posture Back
Shown in Replay, Dove (RP33).
For available textiles, see pages 202-207.

Graphic models are available in Black mesh only.

Graphic™

The Graphic series offers casual style and contemporary scale in an affordable ergonomic design.



Graphic 2738MB - LIMITED QTY AVAILABLE
Mesh Medium Back Posture Back
List Price **\$818**
Shown in Replay, Coal (RP34) with Black Mesh

Mechanism



Tilt-lock mechanism with tilt-tension control

Available immediately in the following textile:

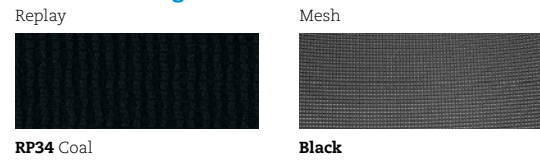

Tye™

The Tye series offers tremendous value in air-flow mesh technology, as well as style.



Tye 1950-4
Mesh High Back Tilter
List Price **\$768**
Shown in Jenny, Ebony (JN02) and Mock Leather, Black (550)



Tye 1951-4
Mesh Medium Back Tilter
List Price **\$734**
Shown in Jenny, Ebony (JN02) and Mock Leather, Black (550)

Available immediately in the following textiles:



MODEL	DESCRIPTION	LIST PRICE (starting at)
2736MB	Mesh Medium Back Posture Back (Armless)	\$711
2737	Upholstered Medium Back Posture Back (Armless)	\$711
2738	Medium Back Posture Back	\$711
2738MB	Mesh Medium Back Posture Back	\$784
2739	Upholstered Medium Back Posture Back	\$784

2DAY LIGHTNING
SHIPS FROM THE FACTORY IN 2 DAYS!



Goal 2237-3 Low Back Multi-Tilter
Shown in Fusion, Cobalt (FU83).
For available textiles, see pages 202-207.

Goal™

Goal is ergonomically and economically engineered for maximum comfort with multiple features typically found on more expensive seating.



Goal 2237-3 - LIMITED QTY AVAILABLE
Low Back Multi-Tilter
List Price **\$668**
Shown in Fusion, Granite (FU77)

Goal 2237-5 - LIMITED QTY AVAILABLE
Low Back Operator
List Price **\$526**
Shown in Fusion, Granite (FU77)



Goal 2237-6 - LIMITED QTY OF FU77 and FU83 AVAILABLE
Low Back Task
List Price **\$438**
Shown in Fusion, Carbon (FU85)

Goal 2239-6 - LIMITED QTY OF FU77 and FU83 AVAILABLE
Low Back Task - Armless
List Price **\$338**
Shown in Fusion, Carbon (FU85)

Available immediately in the following textiles:

Fusion



FU83 Cobalt



FU85 Carbon



FU77 Granite



MODEL	DESCRIPTION	LIST PRICE (starting at)
2235-6	Low Back Task Drafting Stool	\$569
2236-6	Low Back Task Drafting Stool (Armless)	\$501
2237-3	Low Back Multi-Tilter	\$668
2237-5	Low Back Operator	\$526
2237-6	Low Back Task	\$438
2239-6	Low Back Task (Armless)	\$338

For Goal stool see page 31.

For specifications and dimensions see page 46.

Graham™

Graham features a multi-curved back with an impact resistant outer back shell.



Graham 3144
Low Back Ergo-Tilter
List Price **\$667**
Shown in Fusion, Carbon (FU85)

Features

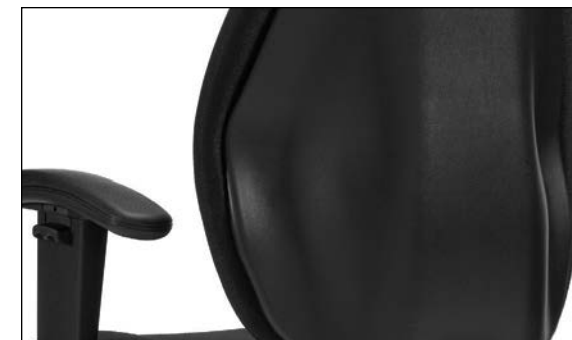

Impact resistant outer back shell

Available immediately in the following textile:

Fusion



FU85 Carbon



2DAY LIGHTNING
SHIPS FROM THE FACTORY IN 2 DAYS!



Graham 3144 Low Back Ergo-Tilter
Shown in Terrace, Tigerlily (TC61).
For available textiles, see pages 202-207.

MODEL	DESCRIPTION	LIST PRICE (starting at)
3144	Low Back Ergo-Tilter	\$667

For specifications and dimensions see page 46.

confer ence + manage ment



All seating is nationally stocked and available immediately or part of the 2DAY LIGHTNING program and ships within two business days.

2DAY LIGHTNING
SHIPS FROM THE FACTORY IN 2 DAYS!



Global Accord 2670-2 High Back Knee-Tilter
Shown in Elevate, Halo (EL51).
For available textiles, see pages 202-207.

Global Accord™

Global Accord features a finely detailed Polished Aluminum arm with a sling style back, upholstered with rolled and pleated details.



Global Accord 2670-4
High Back Tilter
List Price ***1201**
Shown in Allante FRee, Ink (A16F)



Global Accord 2671-4
Medium Back Tilter
List Price ***1163**
Shown in Allante FRee, Gibraltar (A12F)

Available immediately
in the following textiles:

Allante FRee Vinyl



A16F Ink



A12F Gibraltar - LIMITED QTY AVAILABLE

Luray™

As the workplace continues to change, meetings and conferences can still be long days with demanding agendas. Luray provides ample proportions and full back support in an upholstered seating series to keep participants at their best.



Luray 6461
High Back Tilter
List Price (Terrace Fabric) ***1090**
List Price (Allante FRee Vinyl) ***1157**
Shown in Terrace, Ironwork (TC71)

Mechanism



Tilter

Available immediately
in the following textiles:

Terrace Fabric (Grade 1)



TC71 Ironwork



Allante FRee Vinyl (Grade 2)



A16F Ink



Luray 6462 - LIMITED QTY AVAILABLE
Medium Back Tilter
List Price (Terrace Fabric) ***1057**
List Price (Allante FRee Vinyl) ***1119**
Shown in Terrace, Ironwork (TC71)



Plastic fixed arm with self-skinned urethane (ssu) armcap

MODEL	DESCRIPTION	LIST PRICE (starting at)
2670-2	High Back Knee-Tilter	\$1385
2670LM-2	High Back Knee-Tilter (Leather/Mock Leather)	\$1670
2670-4	High Back Tilter	\$1138
2670LM-4	High Back Tilter (Leather/Mock Leather)	\$1430
2671-2	Medium Back Knee-Tilter	\$1350
2671LM-2	Medium Back Knee-Tilter (Leather/Mock Leather)	\$1599
2671-4	Medium Back Tilter	\$1103
2671LM-4	Medium Back Tilter (Leather/Mock Leather)	\$1393
2672-6	Medium Back Stool	\$1355
2672LM-6	Medium Back Stool (Leather/Mock Leather)	\$1584

Solar™

The one-piece frame and matching base are available in Alabaster and Asphalt along with two coordinating mesh colors.

Solar 8457
Medium Back Mesh Tilter
List Price **\$1041**
Shown in Midnight (MDN) Mesh and Alabaster (ABR) frame.



Solar 8457
Medium Back Mesh Tilter
List Price **\$1041**
Shown in Midnight (MDN) Mesh and Alabaster (ABR) frame



Solar 8456
Medium Back Mesh Tilter
List Price **\$950**
Shown in Storm (STM) Mesh and Asphalt (APT) frame



Available immediately in the following textile + finish:

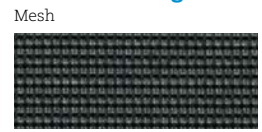

MDN Midnight



ABR Alabaster

Available immediately in the following textile + finish:



STM Storm

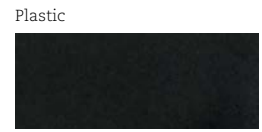

APT Asphalt



For specifications and dimensions see page 51.

2DAY LIGHTNING
SHIPS FROM THE FACTORY IN 2 DAYS!



Synopsis 5090-4 High Back Tilter
Shown in Couture, Neptune (CE75).
For available textiles, see pages 202-207.

Synopsis®

A family of products with exceptional value and a transitional design defines Synopsis.



Synopsis 5090-4 - LIMITED QTY OF UR20 AVAILABLE
High Back Tilter
List Price ***656**
Shown in Urban, Granite Rock (UR20)



Synopsis 5091-4 - LIMITED QTY OF UR20 AVAILABLE
Medium Back Tilter
List Price ***615**
Shown in Urban, Granite Rock (UR20)

Synopsis 5091-4
Medium Back Tilter
List Price ***615**
Shown in Urban, Black Coal (UR22)

Available immediately in the following textiles:

Urban



UR20 Granite Rock



UR22 Black Coal



MODEL	DESCRIPTION	LIST PRICE (starting at)
5080-0	High Back Synchro-Tilter	\$1050
5081-0	Medium Back Synchro-Tilter	\$950
5080-3*	High Back Multi-Tilter	\$1050
5081-3*	Medium Back Multi-Tilter	\$950
5090-4	High Back Tilter	\$656
5091-4	Medium Back Tilter	\$615

*Not UPSable
For additional Synopsis models see page 13.
For specifications and dimensions see page 51.

Height Adjustable Stools

Pair these height adjustable stools and stool kits with Global's height adjustable tables for a truly comfortable ergonomic work environment.



Truform TS S5458-6 Medium Back Heavy Duty Height Adjustable Stool shown in Jenny, Ebony (JN02) with Height Adjustable Tables (page 83).



Stool Kit 2241
Height Adjustable Stool Kit with 6" Extension Tube
List Price ***341**



Stool Kit 2243
Height Adjustable Stool Kit with 10" Gas Cylinder
List Price ***527**



Truform TS S5458-6 - LIMITED QTY AVAILABLE
Medium Back Heavy Duty Height Adjustable Stool
List Price ***1172**
Shown in Jenny, Ebony (JN02)



Goal 2236-6 - LIMITED QTY OF FU77 and FU83 AVAILABLE
Height Adjustable Stool - Armless
List Price ***501**
Shown in Fusion, Graphite (FU77)

For use with existing task chairs. Kit contains Black four-spoked footrest with chrome outer ring, extension tube and Black 26.5" chair base. Casters not included.

For use with existing task chairs. Kit contains Black four-spoked footrest with chrome outer ring, 10" pneumatic gas cylinder and Black 26.5" chair base. Casters not included.

Available immediately in the following textile:

Jenny



JN02 Ebony



Available immediately in the following textiles:

Fusion



FU83 Cobalt



FU85 Carbon



FU77 Granite



For specifications and dimensions see page 52.



Arno™

Perforated leather upholstery panels, one in the seat and one in the back.



Arno 4003
High Back Tilter
List Price **\$471**
Shown in Leather/Mock Leather (Grade 5), Black (550/450)



Arno 4004
Armchair
List Price **\$471**
Shown in Leather/Mock Leather (Grade 5), Black (550/450)

Mechanism



Tilter

Features



Plastic Arm



Black (BK) Base



Perforated Leather

Available immediately in the following textile:

Leather/Mock Leather (Grade 5)



550/450 Black



For specifications and dimensions see page 51.

Concorde®

Concorde is a dual purpose chair; intended for both sophisticated executives and for challenging 24 hour environments that require deep comfort and adjustability.



Concorde 2424-18*
Executive 24 Hr High Back Synchro-Tilter
List Price **\$3829**
Shown in Prescott Leather (Grade 10), Black Ink (PD03)



Mechanism



Revolutionary push button controls located on the armrest provide state-of-the-art ergonomic adjustment for exceptional comfort and support.

Features



Tilt Lock Adjustment

Seat Height Adjustment

Sliding Seat Adjustment

Back Height Adjustment

Available immediately in the following textile:

Prescott Leather (Grade 10)



PD03 Black Ink



For specifications and dimensions see page 52. **Not UPSable*

lounge + reception

Citi™

Each piece in the Citi series complements every other: sofas meld with coffee and end tables, lounge chairs and ottomans pair with sectional pieces, fabrics and finishes harmonize.



Citi 7877*
Three Seat Sofa
List Price **\$2147**
Shown in Leather/Mock
Leather, Black (550/450) with
Tungsten (TUN) legs.



Citi 7875*
Lounge Chair
List Price **\$1264**
Shown in Leather/Mock
Leather, Black (550/450) with
Tungsten (TUN) legs.



Citi 7885*
End Table with Laminate Top
List Price **\$689**
Shown in Black (BLK)
Laminate with Tungsten (TUN)
legs.



Available immediately
in the following textile:

Leather/Mock Leather



550/450 Black

Citi 7876*
Two Seat Sofa
List Price **\$1706**
Shown in Leather/Mock
Leather, Black (550/450) with
Tungsten (TUN) legs.

Citi 7876* (page 35) Two Seat Sofa shown in Leather/Mock Leather, Black (550/450).



For specifications and dimensions see page 53.
*Not UPSable

stack,
nesting +
guest



Spritz 6765C (page 40) Nesting Chair shown in Waterfall, Dance (WA54).

All seating is nationally stocked and available immediately or part of the 2DAY LIGHTNING program and ships within two business days.

Bakhita - INDOOR/OUTDOOR

This versatile polymer chair is UV and weather resistant and can be used in casual dining areas, educational facilities, meeting rooms, pool side, on patios and healthcare rooms.



Bakhita 6750
Stacking Armchair
List Price **\$249**
Shown in Alloy (ALY)

Bakhita 6751
Stacking Side Chair
List Price **\$221**
Shown in Alloy (ALY)



Bakhita 6754
Armless Bar Stool
List Price **\$334**
Shown in Alloy (ALY)

Bakhita + Spyker 6783
Dolly
List Price **\$294**

Available immediately
in the following plastic finishes:



ALY Alloy



CHA Char



MLK Milk



SAN Sandbar - LIMITED QTY
AVAILABLE



Spyker - INDOOR/OUTDOOR

A comfortable, high-quality, lightweight, stacking chair that is incredibly strong and durable. Spyker is an all polymer chair and is weather, UV and stain resistant.



Spyker 6790*
Stacking Armchair
List Price **\$221**
Shown in Alloy (ALY)
(Non UPSable)

Spyker 6790*
Stacking Side Chair
List Price **\$221**
Shown in Char (CHA)
(Non UPSable)



Spyker 6791
Stacking Side Chair
List Price **\$198**
Shown in Alloy (ALY)

Spyker 6791
Stacking Side Chair
List Price **\$198**
Shown in Char (CHA)

Available immediately
in the following plastic finishes:



ALY Alloy



CHA Char



MLK Milk



*Not UPSable

For specifications and dimensions see page 54-55

6780 Round Table shown in Milk (MLK) with 6751 Side Chair shown in Milk (MLK). For Bakhita tables see page 83..

2DAY LIGHTNING
SHIPS FROM THE FACTORY IN 2 DAYS!



Spritz 6765C Flip Up Seat Nesting Chair with Casters
Shown in Jenny, Harvest (JN29).
For available textiles, see pages 202-207.

Spritz 2DAY LIGHTNING models are available in Black mesh only.

Spritz™

Spritz offers an economical, versatile and highly durable choice for the workplace and learning environment.



Spritz 6765C - LIMITED QTY AVAILABLE
Flip Seat Nesting Chair with Casters
List Price ***606**
Shown in Waterfall, Dance (WA54).



Shown nested together on page 37.

Available immediately in the following textile:

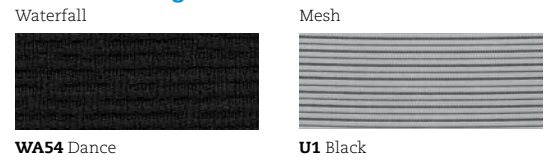

WA54 Dance **U1 Black**



Roma®

Designed to do it all, Roma is the perfect “everywhere” chair.



Roma 1899
Mesh Back Nesting Armchair with Casters
List Price ***674**
Shown in Urban, Black Coal (UR22).



Available immediately in the following textile:

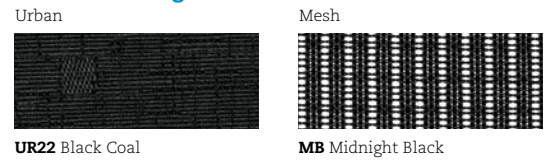

UR22 Black Coal **MB Midnight Black**



2DAY LIGHTNING
SHIPS FROM THE FACTORY IN 2 DAYS!



Roma 1899 Nesting Armchair with Casters
Shown in Match, Wave (MT26).
For available textiles, see pages 202-207.

Roma 2DAY LIGHTNING model is available in Black mesh only.

MODEL	DESCRIPTION	LIST PRICE (starting at)
1899	Nesting Armchair with Casters	*674

For additional Roma model see page 19.

For specifications and dimensions see page 55.

2DAY LIGHTNING
SHIPS FROM THE FACTORY IN 2 DAYS!



Sidero 6900C Stacking Armchair with Casters
Shown in Terrace, Cherry Blossom (TC64).
For available textiles, see pages 202-207.

Sidero™

Multi-purpose seating with a sculptured look, featuring wide curved arms and a round tubular steel frame.



Sidero 6900
Stacking Armchair (shown stacked)
List Price **\$490**
Shown in Urban, Granite Rock (UR20)



Sidero 6901 - LIMITED QTY AVAILABLE
Stacking Side Chair
List Price **\$442**
Shown in Urban, Granite Rock (UR20)

Available immediately in the following textiles:
Urban
 
UR20 Granite Rock **UR22 Black Coal**



MODEL	DESCRIPTION	LIST PRICE (starting at)
6900	Stacking Armchair	\$490
6900C	Stacking Armchair with Casters	\$558
6901	Stacking Side Chair	\$442
6901C	Stacking Side Chair with Casters	\$530
2125WS	Dolly	\$376

Popcorn™



Popcorn 6711*
Armless Stacking Chair
List Price **\$190**
Shown in Cloud (IVC)

Popcorn 6715
Dolly (shown with 6711 in Cloud (IVC) stacked)
List Price **\$643**



Popcorn 6710*
Stacking Armchair
List Price **\$289**
Shown in Shadow (SHW)



Popcorn 6716
Clear Glides (set of 2)
List Price **\$15**

Available immediately in the following plastic finishes:

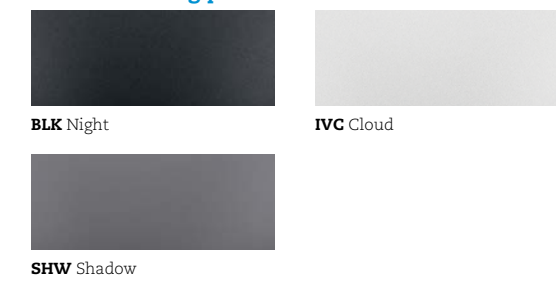

2DAY LIGHTNING
SHIPS FROM THE FACTORY IN 2 DAYS!



Popcorn 6711* Armless Stacking Chair
Shown in Scarlet (SAR) with Polished Aluminum legs.

Popcorn 2DAY LIGHTNING models are available in five polypropylene colors:



MODEL	LIST PRICE (starting at)
6710*	Stacking Armchair \$289
6711*	Armless Stacking Chair \$190
6715	Dolly \$643
6716	Clear Glides (set of 2) \$15

2DAY LIGHTNING
SHIPS FROM THE FACTORY IN 2 DAYS!



Sonic 6508 Armless Stacking Chair
Shown in Scarlet (SAR) with Polished Aluminum legs.

Sonic 2DAY LIGHTNING models are available in five polypropylene colors:



Sonic™



Sonic 6508
Armless Stacking Chair (shown stacked)
List Price **\$275**
Shown in Night (BLK)



Sonic 6508
Armless Stacking Chair
List Price **\$275**
Shown in Black (BLK)

Sonic 6513
Stacking Armchair
List Price **\$336**
Shown in Night (BLK)

Duet™



Duet 6620*
Stacking Armchair
List Price **\$306**
Shown in Night (BLK)



Duet 6621
Armless Stacking Chair
List Price **\$217**
Shown in Shadow (SHW)

Duet 6624
Dolly (shown with 6621 in Cloud (IVC) stacked)
List Price **\$643**

2DAY LIGHTNING
SHIPS FROM THE FACTORY IN 2 DAYS!



Duet 6621 Armless Stacking Chair
Shown in Latte (LAB) with Polished Aluminum legs.

Duet 2DAY LIGHTNING models are available in five polypropylene colors:



MODEL	DESCRIPTION	LIST PRICE (starting at)
6508	Armless Stacking Chair (Poly. Seat and Back)	\$275
6508MB	Armless Stacking Chair (Poly. Seat and Mesh Back)	\$329
6509	Armless Stacking Chair (Uph. Seat and Poly. Back)	\$318
6509MB	Armless Stacking Chair (Uph. Seat and Mesh Back)	\$371
6511	Armless Stacking Chair (Uph. Seat and Back)	\$356
6513	Stacking Armchair (Poly. Seat and Back)	\$336
6513MB	Stacking Armchair (Poly. Seat and Mesh)	\$388
6514	Stacking Armchair (Uph. Seat and Poly. Back)	\$375
6514MB	Stacking Armchair (Uph. Seat and Mesh Back)	\$431
6515	Stacking Armchair (Uph. Seat and Back)	\$411
6517WS	Dolly (Wall Saver)	\$478

(MB models feature a black mesh back)

Available immediately in the following plastic finishes:

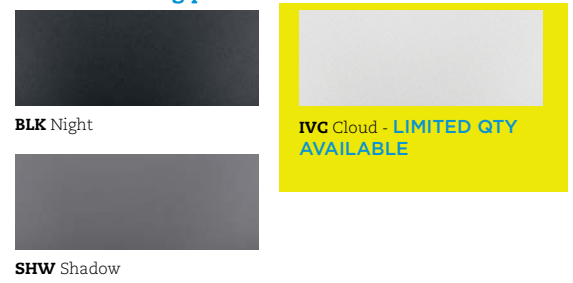

Available immediately in the following plastic finishes:

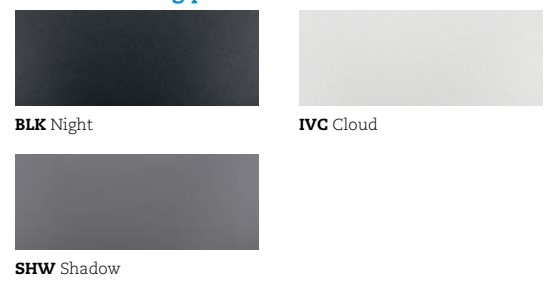

MODEL	DESCRIPTION	LIST PRICE (starting at)
6620*	Stacking Armchair (Poly. Seat and Back)	\$306
6621	Armless Stacking Chair (Poly. Seat and Back)	\$217
6624	Dolly	\$643

*Not UPSable
For specifications and dimensions see page 54.



Goal 2239-6 - LIMITED QTY OF FU77 and FU83 AVAILABLE - page 22

Low Back Task - Armless
 Dimensions: 25w x 24.5d x 39h
 Ergonomic Features: C, D, E, N
 • Standard with a five-legged, injection molded "spider" base and C65 casters
 • Base and frame available in Black (BK) only
 • Fusion, Cobalt (FU83)
 • Fusion, Granite (FU77)
 • Fusion, Carbon (FU85)
 List Price **\$338**



Goal 2237-6 - LIMITED QTY OF FU77 and FU83 AVAILABLE - page 22

Low Back Task
 Dimensions: 25w x 24.5d x 39h
 Ergonomic Features: C, D, E, H, N
 • Standard with adjustable height T-arms with curved urethane armcaps (3N) in Black only
 • Standard with a five-legged, injection molded "spider" base and C65 casters
 • Base and frame available in Black (BK) only
 • Fusion, Cobalt (FU83)
 • Fusion, Granite (FU77)
 • Fusion, Carbon (FU85)
 List Price **\$438**



Goal 2237-5 - LIMITED QTY AVAILABLE - page 22

Low Back Operator
 Dimensions: 25w x 22.5d x 36h
 Ergonomic Features: C, D, F, G, H, N
 • Standard with adjustable height T-arms with curved urethane armcaps (3N) in Black only
 • Standard with a five-legged, injection molded "spider" base and C65 casters
 • Base and frame available in Black (BK) only
 • Fusion, Cobalt (FU83)
 • Fusion, Granite (FU77)
 • Fusion, Carbon (FU85)
 List Price **\$526**



Graham 3144 - page 23
 Low Back Ergo-Tilter
 Dimensions: 25w x 26d x 37.5h
 Ergonomic Features: A, B, C, D, G, H, M, N, S
 • Features a multi-curved backrest with an impact resistant outer back shell
 • Standard with adjustable height T-arms with curved urethane armcaps (3N) in Black Only
 • Standard with a five-legged, injection molded "spider" base and C10 casters
 • Base and frame available in Black (BK) Only
 • Fusion, Carbon (FU85)
 List Price **\$667**



Factor 5541-8 - LIMITED QTY AVAILABLE - page 6
 Mesh Medium Back Weight Sensing Synchro-Tilter
 Dimensions: 26.5w x 24d x 39h
 Ergonomic Features: A, B, C, D, E, H, L, M, N, U
 • Pneumatic seat height adjustment
 • Adjustable lumbar support
 • Side activated sliding seat depth adjustment
 • Height adjustable arms (U2)
 • Cloud frame (IC)
 • Fusion, Granite (FU77)
 • Fusion, Carbon (FU85)
 List Price **\$640**



Factor 5540-8 - LIMITED QTY AVAILABLE - page 6
 Mesh High Back Weight Sensing Synchro-Tilter
 Dimensions: 26.5w x 24d x 41h
 Ergonomic Features: A, B, C, D, E, H, L, M, N, U
 • Pneumatic seat height adjustment
 • Adjustable lumbar support
 • Side activated sliding seat depth adjustment
 • Height adjustable arms (U2)
 • Shadow frame (SH)
 • Fusion, Granite (FU77)
 • Fusion, Carbon (FU85)
 List Price **\$670**



Factor 5540-8 - LIMITED QTY AVAILABLE - page 6
 Mesh High Back Weight Sensing Synchro-Tilter
 Dimensions: 26.5w x 24d x 41h
 Ergonomic Features: A, B, C, D, E, H, L, M, N, U
 • Pneumatic seat height adjustment
 • Adjustable lumbar support
 • Side activated sliding seat depth adjustment
 • Height adjustable arms (U2)
 • Cloud frame (IC)
 • Fusion, Granite (FU77)
 • Fusion, Carbon (FU85)
 List Price **\$670**



Tye 1951-4 - page 21
 Mesh Low Back Tilter
 Dimensions: 25w x 26d x 41h
 Ergonomic Features: A, C, E, H, M, N
 • Contemporary mesh fabric and upholstered panels are used on chair backs
 • Adjustable height T-arms with curved urethane armcaps (3N) in Black Only
 • Five-legged, injection-molded "spider" base
 • C65 casters are standard
 • Seat depth and pneumatic seat height adjustments. Tilt tension adjustment with tilt lock
 • Jenny, Ebony (JN02) and Mock Leather, Black (550)
 List Price **\$734**



Goal 2237-3 - LIMITED QTY AVAILABLE - page 22
 Low Back Multi-Tilter
 Dimensions: 25w x 22.5d x 36h
 Ergonomic Features: A, B, C, D, F, G, H, N, S
 • Standard with adjustable height T-arms with curved urethane armcaps (3N) in Black only
 • Standard with a five-legged, injection molded "spider" base and C65 casters
 • Base and frame available in Black (BK) only
 • Fusion, Cobalt (FU83)
 • Fusion, Granite (FU77)
 • Fusion, Carbon (FU85)
 List Price **\$668**



Factor 5541-8 - page 6
 Mesh Medium Back Weight Sensing Synchro-Tilter
 Dimensions: 26.5w x 24d x 39h
 Ergonomic Features: A, B, C, D, E, H, L, M, N, U
 • Pneumatic seat height adjustment
 • Adjustable lumbar support
 • Side activated sliding seat depth adjustment
 • Height adjustable arms (U2)
 • Black frame (BK)
 • Fusion, Granite (FU77)
 • Fusion, Carbon (FU85)
 List Price **\$595**



Factor 5540-8 - page 6
 Mesh High Back Weight Sensing Synchro-Tilter
 Dimensions: 26.5w x 24d x 41h
 Ergonomic Features: A, B, C, D, E, H, L, M, N, U
 • Pneumatic seat height adjustment
 • Adjustable lumbar support
 • Side activated sliding seat depth adjustment
 • Height adjustable arms (U2)
 • Black frame (BK)
 • Fusion, Granite (FU77)
 • Fusion, Carbon (FU85)
 List Price **\$625**



Factor 5541-8 - LIMITED QTY AVAILABLE - page 6
 Mesh Medium Back Weight Sensing Synchro-Tilter
 Dimensions: 26.5w x 24d x 39h
 Ergonomic Features: A, B, C, D, E, H, L, M, N, U
 • Pneumatic seat height adjustment
 • Adjustable lumbar support
 • Side activated sliding seat depth adjustment
 • Height adjustable arms (U2)
 • Shadow frame (SH)
 • Fusion, Granite (FU77)
 • Fusion, Carbon (FU85)
 List Price **\$640**



Tye 1950-4 - page 21
 Mesh High Back Tilter
 Dimensions: 25w x 26d x 45.5h
 Ergonomic Features: A, C, E, H, M, N
 • Contemporary mesh fabric and upholstered panels are used on chair backs
 • Adjustable height T-arms with curved urethane armcaps (3N) in Black Only
 • Five-legged, injection-molded "spider" base
 • C65 casters are standard
 • Seat depth and pneumatic seat height adjustments. Tilt tension adjustment with tilt lock
 • Jenny, Ebony (JN02) and Mock Leather, Black (550)
 List Price **\$768**



Vion 6321-4C - LIMITED QTY AVAILABLE - page 9
 Mesh High Back Tilter with Fixed Arms (C)
 Dimensions: 25.5w x 24d x 39.25h
 Ergonomic Features: A, B, C, E, H, M, L, M, N, Q, S
 • Pneumatic seat height adjustment
 • Black five-prong, injection molded, fiberglass reinforced nylon Governor base (B7) with dual wheel carpet casters (C1)
 • Fixed "C" arm (Black)
 • Urban, Granite Rock (UR20)
 • Urban, Black Coal (UR22)
 List Price **\$779**



Vion 6322-8 - page 9
 Mesh Medium Back Weight Sensing Synchro-Tilter
 Dimensions: 25.5w x 24d x 38h
 Ergonomic Features: A, B, C, E, H, L, M, N, Q
 • Pneumatic seat height adjustment
 • Black five-prong, injection molded, fiberglass reinforced nylon Governor base (B7) with dual wheel carpet casters (C1)
 • Height and width adjustable arms (AS) that feature a front to back sliding armcap
 • Urban, Granite Rock (UR20)
 • Urban, Black Coal (UR22)
 List Price **\$825**



Vion Fog 6321-0FAFG - LIMITED QTY AVAILABLE - page 11
 Mesh Medium Back Synchro-Tilter with Back Angle Adjustment
 Dimensions: 25.5w x 24d x 41.5h
 Ergonomic Features: A, B, C, E, G, H, L, M, N
 • Pneumatic seat height adjustment
 • Black five-prong, injection molded, fiberglass reinforced nylon Governor base (B7) with dual wheel carpet casters (C1)
 • Height and width adjustable arms (AS) that feature a front to back sliding armcap
 • Fog Frame
 • Fusion, Graphite (FU81)
 • Fusion, Carbon (FU85)
 List Price **\$788**

A Tilt Tension
 Increase or decrease to match body weight. Allows you to rock comfortably, without heavy pushing, reducing muscle fatigue.

B Chair Tilt Lock
 Lock the tilt movement in position(s) to accommodate your working posture. Allows you to lock your chair in a comfortable and supportive position. (can be either single position or infinite style).

C Seat Height
 Raise or lower to allow your feet to rest flat on the floor. Avoids pressure under your thighs, easing blood flow.

D Back Height
 Raise or lower to position lumbar support in your lumbar area. Reduces likelihood of back pain.

E Seat Depth
 Change the depth of the seat to accommodate the length of your thighs. Keeps your back in contact with the backrest while avoiding pressure behind your knees.

G Back Angle
 Adjust to change the angle of your torso in relation to your thighs. Helps reduce disc pressure and relaxes your back muscles.

H Arm Height
 Raise or lower to support your forearms. Reduces muscular effort in neck and shoulders, minimizing risk of pain.

L Synchro-Tilt Movement
 Backrest reclines at a faster rate than the seat, increasing the angle between your torso and thighs. Enhances comfort and encourages dynamic body movement.

M Waterfall Seat Edge
 Reduces pressure at the back of the knee, contributing to good blood flow.

N Properly Contoured Cushions
 Support the body effectively, allowing you to sit longer without discomfort.

Q Width Adjustable Arms
 Allows outward movement of armrests to match shoulder breadth. Ensures armrests properly support forearms, reducing muscular effort in neck and shoulders.

R Arm Rotation
 Rotate armcap to support your forearm in various positions. Reduces muscular effort in neck and shoulders, minimizing risk of pain.

S Center-Tilt Movement
 Chair tilts from a pivot point under the center of the seat allowing you to rock. When your feet are well supported, blood flow is enhanced.

V Lumbar Depth Adjustment
 Increase or decrease curvature of the back to match the profile of your lower back. Enhances comfort and support in the lower lumbar area.



Vion Fog 6322-0FAFG - LIMITED QTY AVAILABLE - page 11
 Mesh Medium Back Synchro-Tilter with Back Angle Adjustment
 Dimensions: 25.5w x 24d x 39.5h
 Ergonomic Features: A, B, C, E, G, H, L, M, N

- Pneumatic seat height adjustment
- Black five-prong, injection molded, fiberglass reinforced nylon Governor base (B7) with dual wheel carpet casters (C1)
- Height and width adjustable arms (AS) that feature a front to back sliding armcap
- Fog Frame
- Fusion, Graphite (FU81)
- Fusion, Carbon (FU85)

List Price **\$750**



Vion 6321-8 - page 9
 Mesh High Back Weight Sensing Synchro-Tilter
 Dimensions: 25.5w x 24d x 40h
 Ergonomic Features: A, B, C, E, H, L, M, N, Q

- Pneumatic seat height adjustment
- Black five-prong, injection molded, fiberglass reinforced nylon Governor base (B7) with dual wheel carpet casters (C1)
- Height and width adjustable arms (AS) that feature a front to back sliding armcap
- Urban, Granite Rock (UR20)
- Urban, Black Coal (UR22)

List Price **\$871**



Graphic 2738MB - LIMITED QTY AVAILABLE - page 20
 Mesh Medium Posture Back
 Dimensions: 25w x 24d x 36h
 Ergonomic Features: A, C, G, H, M, N, Q

- Pneumatic seat height adjustment
- Generous compound curved back and seat
- Breathable black mesh back
- Adjustable height, forward swept arms and "sliding armcaps" (G4)
- Width adjustable arms
- Two-position tilt lock adjustment and tilt tension control
- Five-legged, injection molded, fiberglass reinforced nylon arched base with (C1) casters in Black
- Replay, Coal (RP34)

List Price **\$818**



Truform 5451-3 - page 16
 Medium Back Multi-Tilter
 Dimensions: 26w x 25d x 38.5h
 Ergonomic Features: A, B, C, D, F, G, H, M, N, Q, S

- Pneumatic seat height adjustment
- Standard with adjustable height arms (SC)
- Jenny, Ebony (JN02)

List Price **\$807**



Truform TS5450-3 - page 17
 High Back Multi-Tilter Heavy Duty
 Dimensions: 26w x 25d x 42h
 Ergonomic Features: A, B, C, D, F, G, H, M, N, Q, S

- Pneumatic seat height adjustment
- Standard with adjustable height arms (SC)
- Jenny, Ebony (JN02)

List Price **\$988**



Roma 1906 - LIMITED QTY AVAILABLE - page 19
 Mesh Medium Back Task
 Dimensions: 25.5w x 23.5d x 38h
 Ergonomic Features: A, G, M, N

- Pneumatic seat height adjustment
- Arms are durable fiberglass reinforced Nylon, fixed height. Armcaps are durable Polyurethane (SSU)
- Exclusive chair control mechanism allows the chair back and arms to recline together, while the chair seat moves just enough to ensure comfort
- Black five-prong fiberglass reinforced Nylon base
- (C1) casters are standard
- Urban, Black Coal (UR22)

List Price **\$831**



Granada 3212 - page 15
 Low Back Multi-Tilter
 Dimensions: 26w x 24d x 40h
 Ergonomic Features: A, B, C, D, E, F, G, H, M, N, Q, S

- Pneumatic seat height adjustment
- Standard with adjustable height T-arms with curved urethane armcaps (3N) in Black Only
- Waterfall, Grand (WA50)
- Waterfall, Dance (WA54)

List Price **\$895**



Granada 3217 - page 15
 High Back Multi-Tilter
 Dimensions: 26w x 24.5d x 43h
 Ergonomic Features: A, B, C, D, E, F, G, H, M, N, Q, S

- Pneumatic seat height adjustment
- Standard with adjustable height T-arms with curved urethane armcaps (3N) in Black Only
- Waterfall, Grand (WA50)
- Waterfall, Dance (WA54)

List Price **\$1006**



Truform 5451-8 - LIMITED QTY AVAILABLE - page 16
 Medium Back Weight Sensing Multi-Tilter
 Dimensions: 26w x 25d x 38h
 Ergonomic Features: A, B, C, E, H, M, N, Q

- Pneumatic seat height adjustment
- Standard with adjustable height arms (SC)
- Jenny, Ebony (JN02)

List Price **\$807**



Truform 5450-3 - page 16
 High Back Multi-Tilter
 Dimensions: 26w x 25d x 42h
 Ergonomic Features: A, B, C, D, F, G, H, M, N, Q, S

- Pneumatic seat height adjustment
- Standard with adjustable height arms (SC)
- Jenny, Ebony (JN02)

List Price **\$842**



Truform 5450-8 - LIMITED QTY AVAILABLE - page 16
 High Back Weight Sensing Multi-Tilter
 Dimensions: 26w x 25d x 41.5h
 Ergonomic Features: A, B, C, E, H, M, N, Q

- Pneumatic seat height adjustment
- Standard with adjustable height arms (SC)
- Jenny, Ebony (JN02)

List Price **\$842**



Truform TS5451-3 - page 17
 Medium Back Multi-Tilter Heavy Duty
 Dimensions: 26w x 25d x 38.5h
 Ergonomic Features: A, B, C, D, F, G, H, M, N, Q, S

- Pneumatic seat height adjustment
- Standard with adjustable height arms (SC)
- Jenny, Ebony (JN02)

List Price **\$954**



Looover 2662-8 - page 18
 Mesh Medium Back Weight Sensing Synchro-Tilter
 Dimensions: 25.5w x 25d x 39h
 Ergonomic Features: A, B, C, E, H, L, M, N, Q

- Pneumatic seat height adjustment
- Black five-prong, injection molded, fiberglass reinforced nylon Governor base (B7) with dual wheel carpet casters (C1)
- Height and width adjustable arms (AS) that feature a front to back sliding armcap

• Urban, Granite Rock (UR20) - **LIMITED QTY AVAILABLE**

- Urban, Black Coal (UR22)

List Price **\$902**



Looover 2661-8 - page 18
 Mesh High Back Weight Sensing Synchro-Tilter
 Dimensions: 25.5w x 24d x 42.5h
 Ergonomic Features: A, B, C, E, H, L, M, N, Q

- Pneumatic seat height adjustment
- Black five-prong, injection molded, fiberglass reinforced nylon Governor base (B7) with dual wheel carpet casters (C1)
- Height and width adjustable arms (AS) that feature a front to back sliding armcap

• Urban, Granite Rock (UR20) - **LIMITED QTY AVAILABLE**

- Urban, Black Coal (UR22)

List Price **\$944**



Synopsis 5081-3 - LIMITED QTY AVAILABLE - page 13
 Medium Back Multi-Tilter
 Dimensions: 25w x 24d x 41h
 Ergonomic Features: A, B, C, D, E, G, M, N, Q, S

- Adjustable height T arms with teardrop shaped urethane armcaps (3B)
- Ratchet style back height and pneumatic seat height adjustments
- Vari-Width (WA), Width adjustable arm extensions are standard with adjustable height T arms
- Impact resistant outer back shell
- Sliding seat depth adjustment
- Urban, Granite Rock (UR20)
- Urban, Black Coal (UR22)

List Price **\$950**



Synopsis 5080-3 - LIMITED QTY AVAILABLE - page 13
 High Back Multi-Tilter
 Dimensions: 25w x 24d x 41h
 Ergonomic Features: A, B, C, D, E, G, M, N, Q, S

- Adjustable height T arms with teardrop shaped urethane armcaps (3B)
- Ratchet style back height and pneumatic seat height adjustments
- Vari-Width (WA), Width adjustable arm extensions are standard with adjustable height T arms
- Impact resistant outer back shell
- Sliding seat depth adjustment
- Urban, Granite Rock (UR20)
- Urban, Black Coal (UR22)

List Price **\$1050**



A Tilt Tension
 Increase or decrease to match body weight. Allows you to rock comfortably, without heavy pushing, reducing muscle fatigue.

B Chair Tilt Lock
 Lock the tilt movement in position(s) to accommodate your working posture. Allows you to lock your chair in a comfortable and supportive position. (can be either single position or infinite style).

C Seat Height
 Raise or lower to allow your feet to rest flat on the floor. Avoids pressure under your thighs, easing blood flow.

D Back Height
 Raise or lower to position lumbar support in your lumbar area. Reduces likelihood of back pain.

E Seat Depth
 Change the depth of the seat to accommodate the length of your thighs. Keeps your back in contact with the backrest while avoiding pressure behind your knees.

G Back Angle
 Adjust to change the angle of your torso in relation to your thighs. Helps reduce disc pressure and relaxes your back muscles.

H Arm Height
 Raise or lower to support your forearms. Reduces muscular effort in neck and shoulders, minimizing risk of pain.



L Synchro-Tilt Movement
 Backrest reclines at a faster rate than the seat, increasing the angle between your torso and thighs. Enhances comfort and encourages dynamic body movement.

M Waterfall Seat Edge
 Reduces pressure at the back of the knee, contributing to good blood flow.

N Properly Contoured Cushions
 Support the body effectively, allowing you to sit longer without discomfort.

Q Width Adjustable Arms
 Allows outward movement of armrests to match shoulder breadth. Ensures armrests properly support forearms, reducing muscular effort in neck and shoulders.

R Arm Rotation
 Rotate armcap to support your forearm in various positions. Reduces muscular effort in neck and shoulders, minimizing risk of pain.

S Center-Tilt Movement
 Chair tilts from a pivot point under the center of the seat allowing you to rock. When your feet are well supported, blood flow is enhanced.

V Lumbar Depth Adjustment
 Increase or decrease curvature of the back to match the profile of your lower back. Enhances comfort and support in the lower lumbar area.



G1 Ergo Select 7331 - LIMITED QTY AVAILABLE - page 14

Medium Back Weight Sensing Synchro-Tilter

Dimensions: 24w x 21.5d x 42h

Ergonomic Features: A, B, C, D, E, L, M, N, Q, T

- Pneumatic seat height, forward and rearward seat tilt with infinite lock, free floating back angle control, tilt tension control and side activated sliding seat depth
- Stitch detail on edges of seat and back is discrete, using matched thread as standard
- Height and width adjustable arms with sliding armcaps (G5)
- Waterfall, Dance (WA54)

List Price ***1132**



G1 Ergo Select 7332 - LIMITED QTY AVAILABLE - page 14

High Back Weight Sensing Synchro-Tilter

Dimensions: 24.5w x 23d x 45.5h

Ergonomic Features: A, B, C, D, E, L, M, N, Q, T

- Pneumatic seat height, forward and rearward seat tilt with infinite lock, free floating back angle control, tilt tension control and side activated sliding seat depth.
- Stitch detail on edges of seat and back is discrete, using matched thread as standard.
- Height and width adjustable arms with sliding armcaps (G5)
- Waterfall, Dance (WA54)

List Price ***1194**



Aspen 2852-3 - LIMITED QTY AVAILABLE - page 12

Medium Back Multi-Tilter

Dimensions: 25w x 24d x 37h

Ergonomic Features: A, B, C, D, E, F, G, H, M, N, Q, S

- Ratchet back height adjustment.
- Height and width adjustable arms (AS) that feature a sliding armcap
- Seat depth adjustment
- Jenny, Charcoal (JN11)

List Price ***1158**



Aspen 2851-3 - LIMITED QTY AVAILABLE - page 12

High Back Multi-Tilter

Dimensions: 25w x 24d x 41h

Ergonomic Features: A, B, C, D, E, F, G, H, M, N, Q, S

- Ratchet back height adjustment.
- Height and width adjustable arms (AS) that feature a sliding armcap.
- Seat depth adjustment
- Jenny, Charcoal (JN11)

List Price ***1193**



Arno 4003 - page 32

High Back Tilter

Dimensions: 25w x 29d x 42h

Ergonomic Features: A, B, C, N, S

- Perforated leather inserts in the seat and back surfaces
- Standard Black (BK) molded flared loop arms and a five-legged injection molded base with (C65) casters.
- Leather/Mock Leather, Black (550/450)

List Price ***471**



Synopsis 5091-4 - LIMITED QTY OF UR20 AVAILABLE - page 30

Medium Back Tilter

Dimensions: 24.5w x 26.5d x 39.5h

Ergonomic Features: A, B, C, M, N, S

- Ratchet style back height and pneumatic seat height adjustments
- Impact resistant outer back shell.
- Sliding seat depth adjustment
- Urban, Granite Rock (UR20)
- Urban, Black Coal (UR22)

List Price ***615**



Synopsis 5090-4 - LIMITED QTY OF UR20 AVAILABLE - page 30

High Back Tilter

Dimensions: 24.5w x 26.5d x 43.5h

Ergonomic Features: A, B, C, M, N, S

- Ratchet style back height and pneumatic seat height adjustments
- Impact resistant outer back shell.
- Sliding seat depth adjustment
- Urban, Granite Rock (UR20)
- Urban, Black Coal (UR22)

List Price ***656**



Solar 8456 - page 29

Medium Back Mesh Tilter

Dimensions: 23.25w x 25d x 36h

Ergonomic Features: A, B, C, D, E, H, L, M, N, U

- One piece molded frame is extremely light (chair weighs 24 lbs) and exceeds BIFMA standard for commercial applications
- Cascading forward seat surface and reverse edge
- Integrated seat height adjustment lever is intuitive and easy to utilize
- The under seat structure maintains the seamless and fluid aesthetic that defines Solar
- (C1) casters are standard
- Mesh, Storm (STM)
- Plastic, Asphalt (APT)

List Price ***950**



Solar 8457 - page 29

Medium Back Mesh Tilter

Dimensions: 23.25w x 25d x 36h

Ergonomic Features: A, B, C, D, E, H, L, M, N, U

- One piece molded frame is extremely light (chair weighs 24 lbs) and exceeds BIFMA standard for commercial applications
- Cascading forward seat surface and reverse edge
- Integrated seat height adjustment lever is intuitive and easy to utilize
- The under seat structure maintains the seamless and fluid aesthetic that defines Solar
- (C1) casters are standard
- Mesh, Midnight (MDN)
- Plastic, Alabaster (ABR)

List Price ***1041**



Luray 6462 - LIMITED QTY AVAILABLE - page 27

Low Back Tilter

Dimensions: 25w x 25d x 39.5h

Ergonomic Features: A, B, C, M, N, S, U

- Stitch detail on edges of seat and back is discrete, using matched thread as standard
- Standard with Global's high quality Soft Descent™ pneumatic lift
- Five prong, injection molded, fiberglass reinforced, nylon medium rise base (B7B) with (C1) dual wheel carpet casters
- Terrace, Ironwork (TC71)
- Allante FRee, Ink (A16F)

List Price (Terrace Fabric - Grade 1) ***1057**

List Price (Allante FRee Vinyl - Grade 2) ***1119**



Luray 6461 - page 27

High Back Tilter

Dimensions: 25w x 25d x 42.5h

Ergonomic Features: A, B, C, M, N, S, U

- Stitch detail on edges of seat and back is discrete, using matched thread as standard
- Standard with Global's high quality Soft Descent™ pneumatic lift
- Five prong, injection molded, fiberglass reinforced, nylon medium rise base (B7B) with (C1) dual wheel carpet casters
- Terrace, Ironwork (TC71)
- Allante FRee, Ink (A16F)

List Price (Terrace Fabric - Grade 1) ***1090**

List Price (Allante FRee Vinyl - Grade 2) ***1157**



Global Accord 2671-4 - page 26

Medium Back Tilter

Dimensions: 25w x 25d x 37h

Ergonomic Features: A, B, C, M, N, S, U

- Features a sling back style that molds to and evenly supports the back and spine
- Cast aluminum with a mirror finish accent the arms and base
- Soft touch self-skinned urethane armcaps are available in Black Only.
- Standard with an arched aluminum spider base and (C1) casters
- Allante FRee, Ink (A16F)

List Price (Allante FRee, Gibraltar (A12F) - LIMITED QTY AVAILABLE)

List Price ***1103**



- A Tilt Tension**
Increase or decrease to match body weight. Allows you to rock comfortably, without heavy pushing, reducing muscle fatigue.
- B Chair Tilt Lock**
Lock the tilt movement in position(s) to accommodate your working posture. Allows you to lock your chair in a comfortable and supportive position. (can be either single position or infinite style).
- C Seat Height**
Raise or lower to allow your feet to rest flat on the floor. Avoids pressure under your thighs, easing blood flow.
- D Back Height**
Raise or lower to position lumbar support in your lumbar area. Reduces likelihood of back pain.
- E Seat Depth**
Change the depth of the seat to accommodate the length of your thighs. Keeps your back in contact with the backrest while avoiding pressure behind your knees.
- G Back Angle**
Adjust to change the angle of your torso in relation to your thighs. Helps reduce disc pressure and relaxes your back muscles.
- H Arm Height**
Raise or lower to support your forearms. Reduces muscular effort in neck and shoulders, minimizing risk of pain.



- L Synchro-Tilt Movement**
Backrest reclines at a faster rate than the seat, increasing the angle between your torso and thighs. Enhances comfort and encourages dynamic body movement.
- M Waterfall Seat Edge**
Reduces pressure at the back of the knee, contributing to good blood flow.
- N Properly Contoured Cushions**
Support the body effectively, allowing you to sit longer without discomfort.
- Q Width Adjustable Arms**
Allows outward movement of armrests to match shoulder breadth. Ensures armrests properly support forearms, reducing muscular effort in neck and shoulders.
- R Arm Rotation**
Rotate armcap to support your forearm in various positions. Reduces muscular effort in neck and shoulders, minimizing risk of pain.
- S Center-Tilt Movement**
Chair tilts from a pivot point under the center of the seat allowing you to rock. When your feet are well supported, blood flow is enhanced.
- V Lumbar Depth Adjustment**
Increase or decrease curvature of the back to match the profile of your lower back. Enhances comfort and support in the lower lumbar area.



Global Accord 2670-4 - page 26

High Back Tilter
 Dimensions: 25w x 25d x 44h
 Ergonomic Features: A, B, C, M, N, S, U

- Features a sling back style that molds to and evenly supports the back and spine
- Cast aluminum with a mirror finish accent the arms and base
- Soft touch self-skinned urethane armcaps are available in Black Only.
- Standard with an arched aluminum spider base and (C1) casters
- Allante FRee, Ink (A16F)

• Allante FRee, Gibraltar (A12F) - LIMITED QTY AVAILABLE

List Price **\$1138**



Concorde 2424-18 - page 33

24 Hr High Back Synchro-Tilter
 Dimensions: 28.5w x 27d x 50h

Ergonomic Features: A, B, C, D, E, L, M, N, Q, T

- Seat cushion with Velcro attachment is easily removed and replaced
- Rated for Multi-Shift use for persons up to 350 pounds
- Pneumatic seat height adjustment and 5 - position tilt lock. Tilt tension control
- Ratchet style back height adjustment
- Standard with a reinforced five-legged, injection molded base with (C10) casters, Black (BK) Only
- Prescott, Black Ink (PD03)

List Price **\$3829**



Drafting 2241 - page 31

- Drafting Stool Kit
- Stool kit with 6" extension tube
 - Contains Black four-spoked footrest with chrome outer ring, extension tube and Black 26.5" chair base
 - For use with existing task chairs
 - Casters not included

List Price **\$341**



Drafting 2243 - page 31

- Drafting Stool Kit
- Stool kit with 10" gas cylinder
 - Contains Black four-spoked footrest with chrome outer ring, 10" gas cylinder and Black 26.5" chair base.
 - For use with existing task chairs
 - Casters not included

List Price **\$527**



Goal 2236-6 - LIMITED QTY OF FU77 and FU83 AVAILABLE - page 31

Drafting Stool - Armless
 Dimensions: 20.5w x 24.5d x 48h

Ergonomic Features: C, D, H, N

- Standard with a five-legged, injection molded "spider" base and (C65) casters
- Base and frame available in Black (BK) only
- Fusion, Cobalt (FU83)
- Fusion, Granite (FU77)
- Fusion, Carbon (FU85)

List Price **\$501**

Truform TS S5458-6 - LIMITED QTY AVAILABLE - pages 17, 31

Medium Back Heavy Duty Drafting Chair
 Dimensions: 26w x 25d x 43h

Ergonomic Features: A, B, C, J, M, N

- Pneumatic seat height adjustment
- Standard with adjustable height arms (SC)
- Jenny, Ebony (JN02)

List Price **\$1172**



- A Tilt Tension**
Increase or decrease to match body weight. Allows you to rock comfortably, without heavy pushing, reducing muscle fatigue.
- B Chair Tilt Lock**
Lock the tilt movement in position(s) to accommodate your working posture. Allows you to lock your chair in a comfortable and supportive position. (can be either single position or infinite style).
- C Seat Height**
Raise or lower to allow your feet to rest flat on the floor. Avoids pressure under your thighs, easing blood flow.
- D Back Height**
Raise or lower to position lumbar support in your lumbar area. Reduces likelihood of back pain.
- E Seat Depth**
Change the depth of the seat to accommodate the length of your thighs. Keeps your back in contact with the backrest while avoiding pressure behind your knees.
- G Back Angle**
Adjust to change the angle of your torso in relation to your thighs. Helps reduce disc pressure and relaxes your back muscles.
- H Arm Height**
Raise or lower to support your forearms. Reduces muscular effort in neck and shoulders, minimizing risk of pain.



Citi 7885 - page 35

End Table with Laminate Top
 Dimensions: 24w x 20d x 20h

- Compact, contemporary design includes raised legs
- Laminate, Black (BLK)

List Price **\$689**



Citi 7875 - page 35

Lounge Chair
 Dimensions: 30w x 31d x 30h

- Compact, contemporary design includes raised legs
- Fully upholstered. Fixed seat and back cushions. Raised metal tubular legs
- Horizontal stitch detail
- Leather/Mock Leather, Black (550/450)

List Price **\$1264**



Citi 7876 - page 35

Two Seat Sofa
 Dimensions: 50.5w x 31d x 30h

- Compact, contemporary design includes raised legs
- Fully upholstered. Fixed seat and back cushions. Raised metal tubular legs
- Horizontal stitch detail
- Leather/Mock Leather, Black (550/450)

List Price **\$1706**



Citi 7877 - page 35

Three Seat Sofa
 Dimensions: 72w x 31d x 30h

- Compact, contemporary design includes raised legs
- Fully upholstered. Fixed seat and back cushions. Raised metal tubular legs
- Horizontal stitch detail
- Leather/Mock Leather, Black (550/450)

List Price **\$2147**



- L Synchro-Tilt Movement**
Backrest reclines at a faster rate than the seat, increasing the angle between your torso and thighs. Enhances comfort and encourages dynamic body movement.
- M Waterfall Seat Edge**
Reduces pressure at the back of the knee, contributing to good blood flow.
- N Properly Contoured Cushions**
Support the body effectively, allowing you to sit longer without discomfort.
- Q Width Adjustable Arms**
Allows outward movement of armrests to match shoulder breadth. Ensures armrests properly support forearms, reducing muscular effort in neck and shoulders.
- R Arm Rotation**
Rotate armcap to support your forearm in various positions. Reduces muscular effort in neck and shoulders, minimizing risk of pain.
- S Center-Tilt Movement**
Chair tilts from a pivot point under the center of the seat allowing you to rock. When your feet are well supported, blood flow is enhanced.
- V Lumbar Depth Adjustment**
Increase or decrease curvature of the back to match the profile of your lower back. Enhances comfort and support in the lower lumbar area.



Duet 6621 - page 45
Stacking Side Chair - Armless
Dimensions: 20.75w x 22.75d x 33.25h

- Clear polycarbonate glides (CG) are standard and suitable for carpet, rubber or concrete flooring
- Weight capacity for this series is 300 lbs.
- Night (BLK)
- Cloud (IVC)
- Shadow (SHW)

List Price **\$217**



Duet 6620 - page 45
Stacking Armchair
Dimensions: 25.5w x 22.75d x 33.25h

- Clear polycarbonate glides (CG) are standard and suitable for carpet, rubber or concrete flooring
- Weight capacity for this series is 300 lbs.
- Night (BLK)
- Cloud (IVC)
- Shadow (SHW)

List Price **\$306**



Popcorn 6711 - page 43
Stacking Side Chair - Armless
Dimensions: 20w x 23.5d x 32.5h

- Chair frame is constructed of 1/2" diameter solid chrome steel rod
- Wall saver frame design; the base touches the wall before the upper back to protect the wall from damage
- Upper back features a cut out hand hold to assist in stacking and transportation
- Seat and back is a one piece polypropylene shell
- Night (BLK)
- Cloud (IVC)
- Shadow (SHW)

List Price **\$190**



Popcorn 6710 - page 43
Stacking Armchair
Dimensions: 24.5w x 23.5d x 32.5h

- Chair frame is constructed of 1/2" diameter solid chrome steel rod
- Wall saver frame design; the base touches the wall before the upper back to protect the wall from damage
- Upper back features a cut out hand hold to assist in stacking and transportation
- Seat and back is a one piece polypropylene shell
- Night (BLK)
- Cloud (IVC)
- Shadow (SHW)

List Price **\$289**



Spyker 6790 - page 39
Stacking Armchair
Dimensions: 17.91w x 20.86d x 31.29h

- All polymer chair intended for use indoors or outdoors. Weather resistant, UV resistant, stain resistant
- Chair legs are equipped with translucent non-marking glides as standard
- Alloy (ALY)
- Char (CHA)

List Price **\$221**



Sonic 6508 - page 44
Stacking Side Chair - Armless
Dimensions: 21.5w x 21.5d x 33h

- Standard with a straight leg
- Standard with Chrome (CH) legs
- Night (BLK)
- Cloud (IVC) - **LIMITED QTY AVAILABLE**
- Shadow (SHW)

List Price **\$275**



Sonic 6513 - page 44
Stacking Armchair
Dimensions: 23w x 21.5d x 33h

- Standard with a straight leg
- Standard with Chrome (CH) legs
- Night (BLK)
- Cloud (IVC) - **LIMITED QTY AVAILABLE**
- Shadow (SHW)

List Price **\$336**



Sidero 6901 - LIMITED QTY AVAILABLE - page 42
Stacking Side Chair - Armless
Dimensions: 21w x 24d x 33h

- The back of the chair is compound curved to provide comfort and support
- Four legged models can be stacked 5 high on the floor
- Standard glide is a durable Black Polypropylene foot
- Urban, Granite Rock (UR20)
- Urban, Black Coal (UR22)

List Price **\$442**



Bakhita 6751 - page 39
Stacking Side Chair - Armless
Dimensions: 18w x 21d x 31.5h

- All polymer chair intended for use indoors or outdoors. Weather resistant, UV resistant, stain resistant
- Inside is a structural nylon frame for strength. Outside is a durable polypropylene light fast compound
- Chair legs are equipped with translucent non-marking glides as standard
- Alloy (ALY)
- Char (CHA)
- Milk (MLK)
- Sandbar (SAN) - **LIMITED QTY AVAILABLE**

List Price **\$221**



Bakhita 6750 - page 39
Stacking Armchair
Dimensions: 22.5w x 21d x 31.5h

- All polymer chair intended for use indoors or outdoors. Weather resistant, UV resistant, stain resistant
- Inside is a structural nylon frame for strength. Outside is a durable polypropylene light fast compound
- Chair legs are equipped with translucent non-marking glides as standard
- Alloy (ALY)
- Char (CHA)
- Milk (MLK)
- Sandbar (SAN) - **LIMITED QTY AVAILABLE**

List Price **\$249**



Bakhita 6754 - page 39
Stacking Stool - Armless
Dimensions: 19.25w x 18.75d x 40.5h

- All polymer chair intended for use indoors or outdoors. Weather resistant, UV resistant, stain resistant
- Inside is a metal frame for strength. Outside is a durable polypropylene light fast compound
- Chair legs are equipped with translucent non-marking glides as standard
- Alloy (ALY)
- Char (CHA)
- Milk (MLK)
- Sandbar (SAN) - **LIMITED QTY AVAILABLE**

List Price **\$334**



Spyker 6791 - page 39
Stacking Side Chair - Armless
Dimensions: 17.91w x 20.86d x 31.29h

- All polymer chair intended for use indoors or outdoors. Weather resistant, UV resistant, stain resistant
- Chair legs are equipped with translucent non-marking glides as standard
- Alloy (ALY)
- Char (CHA)

List Price **\$198**



Arno 4004 - page 32
High Back Tilter
Dimensions: 25w x 29d x 42h

Ergonomic Features: A, B, C, N, S

- Perforated leather inserts in the seat and back surfaces
- Standard Black (BK) molded flared loop arms
- Leather/Mock Leather, Black (550/450)

List Price **\$471**



Sidero 6900 - page 42
Stacking Armchair
Dimensions: 25.5w x 24d x 33h

- Wide curved arms and a round tubular steel frame, with wall save construction
- Arms are 2 1/8 inches wide and full length, and are made from incredibly strong fiberglass reinforced nylon
- The back of the chair is compound curved to provide comfort and support
- Four legged models can be stacked 5 high on the floor
- Standard glide is a durable Black Polypropylene foot.
- Urban, Granite Rock (UR20)
- Urban, Black Coal (UR22)

List Price **\$490**



Spritz 6765C - LIMITED QTY AVAILABLE - page 40
Flip Seat Nesting Chair with Casters
Dimensions: 23.75w x 23d x 33h

Ergonomic Features: G, M, N

- Translucent mesh and models for all applications.
- Features an auto-adjusting comfort back that reacts to body pressure and articulates 12°.
- Flip up seat allowing chairs to nest horizontally.
- Waterfall, Dance (WA54)

List Price **\$606**



Roma 1899 - page 19, 41
Mesh Back Nesting Armchair
Dimensions: 24.5w x 23.6d x 36h

Ergonomic Features: M, N

- The horizontal nesting chairs are easy to store. Simply flip the seat upward and then roll into nesting position, like a shopping cart.
- Arms are durable fiberglass reinforced nylon, fixed height. Armcaps are durable polyurethane (SSU), soft and warm to the touch.
- Stocked in Black (BLK).
- (C1) casters are standard.
- Urban, Black Coal (UR22)

List Price **\$674**



A Tilt Tension
Increase or decrease to match body weight. Allows you to rock comfortably, without heavy pushing, reducing muscle fatigue.



B Chair Tilt Lock
Lock the tilt movement in position(s) to accommodate your working posture. Allows you to lock your chair in a comfortable and supportive position. (can be either single position or infinite style).



C Seat Height
Raise or lower to allow your feet to rest flat on the floor. Avoids pressure under your thighs, easing blood flow.



D Back Height
Raise or lower to position lumbar support in your lumbar area. Reduces likelihood of back pain.



E Seat Depth
Change the depth of the seat to accommodate the length of your thighs. Keeps your back in contact with the backrest while avoiding pressure behind your knees.



G Back Angle
Adjust to change the angle of your torso in relation to your thighs. Helps reduce disc pressure and relaxes your back muscles.



H Arm Height
Raise or lower to support your forearms. Reduces muscular effort in neck and shoulders, minimizing risk of pain.



L Synchro-Tilt Movement
Backrest reclines at a faster rate than the seat, increasing the angle between your torso and thighs. Enhances comfort and encourages dynamic body movement.



M Waterfall Seat Edge
Reduces pressure at the back of the knee, contributing to good blood flow.



N Properly Contoured Cushions
Support the body effectively, allowing you to sit longer without discomfort.



Q Width Adjustable Arms
Allows outward movement of armrests to match shoulder breadth. Ensures armrests properly support forearms, reducing muscular effort in neck and shoulders.



R Arm Rotation
Rotate armcap to support your forearm in various positions. Reduces muscular effort in neck and shoulders, minimizing risk of pain.



S Center-Tilt Movement
Chair tilts from a pivot point under the center of the seat allowing you to rock. When your feet are well supported, blood flow is enhanced.



V Lumbar Depth Adjustment
Increase or decrease curvature of the back to match the profile of your lower back. Enhances comfort and support in the lower lumbar area.

2day

lightning



Spritz Nester – 2 models available



Factor – 2 models available



Novello – 4 models available

Global's 2DAY LIGHTNING program offers many of our best selling models upholstered in your choice of our most popular textiles.

The 2DAY LIGHTNING program features easy customization with extensive upholstery choices. Global's lightning fast production and shipping make it simple to order and ideal for tight deadlines!

Need quick, simple and custom seating? Think Global!



Work + Task



Factor (maximum 50)
5540-8
5541-8
Black Mesh + Frame / U2 Arms only



Goal (maximum 50)
2235-6
2236-6
2237-3
2237-5
2237-6
2239-6



Graham (maximum 50)
3144



Granada Deluxe (maximum 50)
1170-3
1171-3
TS1170-3
TS1171-3



Graphic (maximum 50)
2736MB
2737
2738
2738MB
2739
Black Mesh only



Loover (maximum 50)
2661-0 2661-3 2661-4
2661-8 2662-0 2662-3
2662-4 2662-8
5 Vue Mesh Colors:
Coal Black (VU19), Desert Sand (VU11),
Quarry Grey (VU15), Sandy Beach (VU10),
Tidal Wave (VU16)



Roma (maximum 50)
1901
1906
1906RA
Black Mesh only



Supra X (maximum 50)
5333-3
5336-1
5336-3
5337-6
5338-6
5339-6



Triumph (maximum 50)
3650-3
3650-8
3651-3
3651-8



Truform (maximum 50)
5450-0 5450-3 5450-4
5450-8 5451-0 5451-3
5451-4 5451-8 5457-6
5458-6 S5457-6 S5458-6
TS5450-3 TS5451-3



Weev (maximum 50)
2220-3
2220-4
2220-8
2221-3
2221-4
2221-8
Black Mesh only

Work + Task



Vion (maximum 50)

6321-0	6321-3	6321-4	6321-8	6322-0	6322-3	6322-4
6322-8	6324	6324C	6325	6325C	6327-6	6328-6
TS6321-3	TS6322-3	6331-0	6331-3	6331-4	6331-8	6332-0
6332-3	6332-4	6332-8	6335			

5 Vion Mesh Colors:
Black (MS69), Blue (MS72), Natural (MS74), Stone (MS71), Rope (MS73)



Vion Fog (maximum 50)

6321-0FAFG	6321-3FAFG	6321-4FAFG	6321-8FAFG	6322-0FAFG
6322-3FAFG	6322-4FAFG	6322-8FAFG	6324FO	6324CFO
6325FO	6325CFO	6327-6FAFG	6328-6FAFG	TS6321-3FAFG
TS6322-3FAFG	6331-0FAFG	6331-3FAFG	6331-4FAFG	6331-8FAFG
6332-0FAFG	6332-3FAFG	6332-4FAFG	6332-8FAFG	6335FO

5 Vion Mesh Colors:
Black (MS69), Blue (MS72), Natural (MS74), Stone (MS71), Rope (MS73)

Conference + Management



Global Accord (maximum 50)

2670-2	2670-4	2670LM-2
2670LM-4	2671-2	2671-4
2671LM-2	2671LM-4	2672-6
2672LM-6		



Global Accord Mesh (maximum 50)

2676-2	2676-4	2676LM-2
2676LM-4	2677-2	2677-4
2678-6	2677LM-2	2677LM-4
2678LM-6		

5 Vue Mesh Colors:
Coal Black (VU19), Desert Sand (VU11),
Quarry Grey (VU15), Sandy Beach (VU10),
Tidal Wave (VU16)



Novello (maximum 50)

6400
6401
6410
6411

Black Shell / Arm / Armcap only



Supra (maximum 50)

5330-4 5
5330L-4 5
5331-4 5
5331L-4 5



Synopsis (maximum 50)

5080-0	5080-3	5081-0
5081-3	5090-4	5091-4

Stack, Nesting + Guest



Sidero (maximum 50)

6900
6900C
6901
6901C
2125WS (chair dolly)



Sonic (maximum 100)

6508	6508-1	6508MB	6508MB-1	6509	6509-1	6509MB
6509MB-1	6511	6511-1	6513	6513-1	6513MB	6513MB-1
6514	6514-1	6514MB	6514MB-1	6515	6515-1	6517WS

5 Plastic Colors:
Night (BLK), Latte (LAB), Scarlet (SAR),
Cloud (IVC), Shadow (SHW)

Black Mesh on MB models



Spritz (maximum 50)

6764C
6765C

Black Mesh only



Roma Nester (maximum 50)

1890
1899

Black Mesh only

3 Frame Finishes:
Black (BLK), Chrome (CHM),
Tungsten (TUN)



Duet (maximum 100)

6620	6620-1	6621
6621-1	6621-2	6624

5 Plastic Colors:
Night (BLK), Latte (LAB), Scarlet (SAR),
Cloud (IVC), Shadow (SHW)



Popcorn (maximum 100)

6710	6710-1	6711
6710-2	6711-1	6715
6711-2	6716 Clear Glides (set of 2)	

5 Plastic Colors:
Night (BLK), Latte (LAB), Scarlet (SAR),
Cloud (IVC), Shadow (SHW)

Terms and Conditions

• All product series have MAXIMUM order quantities which can be fulfilled within the 2 Day Lightning program. These are noted next to each series. For greater quantities, please contact CustomerCare for lead times and terms.

- Orders must clearly state, "2 Day Lightning" at the time of submittal
- Program is limited to exact models within series listed above
- Program is limited to exact textile

patterns listed and exact colorways carded

- Orders cannot be changed or canceled after order acknowledgment
- Current Global list pricing applies at the time of order
- All eligible models are UPSable; Global reserves the right to ship "best way"
- Bakhita, Popcorn, Duet and Sonic models may be multiple packaged and shipped "best way"
- Orders must be clean with correct model numbers, options, textiles,

correct pricing, etc., to apply

- Dealer must be in good standing and within terms for order to be processed without delay
- Finished products will ship from our factories in as little as two business days.
- Program available in the 48 contiguous United States
- Orders to ship outside Global's distribution model; order shipment address can be to the dealer or end-user directly

- Standard model options listed under Optional Features section in the price list are available. Standard model options include aluminum bases, painted frame finishes, ballistic nylon backs, glide options and hard surface casters. Memory Foam as a standard option is not available (standard lead-times apply).

work space + meeting areas



Zira

Zira offers hundreds of mix and match components to meet any design specification. Components can be freestanding for single workstation configurations, or brought together to form multiple work groups.



Silver bar handles (HQ) come standard on our stocked product. Locks and hardware feature a matching silver finish.

Available immediately in the following finish:



ACJ Absolute Acajou



HQ Handle

1" thick (A3) worksurfaces feature Global's preferred edging in a matching color.

Run-off surfaces feature a silver metal leg with 1/2" adjustable glides.



Zira Layout Shown

Absolute Acajou (ACJ)

Model	Description	List Price
Z2472T	24" Deep Freestanding Table	
Z16L2BFS+HQ	Box, Box, File Storage Shell	
Z72S42H+HQ	Open Hutch with Closed Back	
ZHBC72	Bookcase	
PH3T6601	Height Adjustable Table Base	
PHAT2970T	Height Adjustable Table Top	

Components Shown

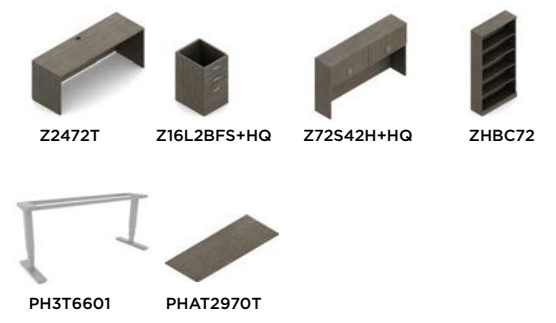

Seating shown Factor 5540-8 with Shadow Frame (SH) (page 6)

Available immediately in the following finish:

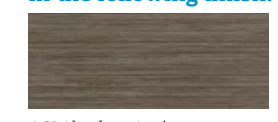

ACJ Absolute Acajou



HQ Handle



Zira Layout Shown

Absolute Acajou (ACJ)

Model	Description	List Price
Z2472T	24" Deep Freestanding Table	
Z16L2ES+HQ	File, File Storage Shell	
Z16L2BFS+HQ	Box, Box, File Storage Shell	
Z72S42H+HQ	Open Hutch with Closed Back	
Z3072F23+HQ	Double Pedestal Desk	
Z36L2E	File, File Storage Module	

Components Shown

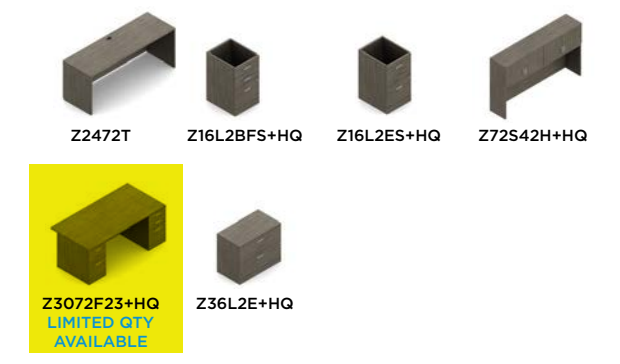

Seating shown Factor 5541-8 with Cloud Frame (IC) (page 6)

Available immediately in the following finish:

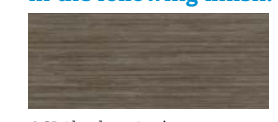

ACJ Absolute Acajou



HQ Handle

Zira INstock components



Z3072F23+HQ - LIMITED QTY AVAILABLE
Double Pedestal Desk
72w x 30d x 29h



Z3072F3L+HQ
Single Pedestal Desk - LEFT
72w x 30d x 29h



Z3072F3R+HQ
Single Pedestal Desk - RIGHT
72w x 30d x 29h



Z2448ER
Flush Return - RIGHT
24w x 48d x 29h
*626



Z2448EL
Flush Return - LEFT
24w x 48d x 29h
*626



Z2448FB
Flush Bridge
24w x 48d x 29h
*547



Z2472T
24" Deep Freestanding Table
72w x 24d x 29h
*808



Z3060MRR
Return w/Metal Leg - RIGHT
60w x 30d x 29h
*807



Z36L2ES+HQ - LIMITED QTY AVAILABLE
File, File Storage Shell
36w x 23.4d x 28.5h
*1283



Z16L2ES+HQ
File, File Storage Shell
16w x 23.4d x 28.5h
*708



Z16L2BFS+HQ
Box, Box, File Storage Shell
16w x 23.4d x 28.5h
*816



Z36L2E+HQ
File, File Storage Module
36w x 24d x 30h
*1576



ZHBC72
Bookcase
36w x 12d x 72.4h
*1003



Z72S42H+HQ
Open Hutch with Closed Back
72w x 15d x 42.4h
*1489

Available immediately in the following finish:

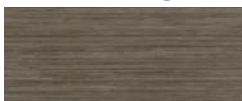

ACJ Absolute Acajou



HQ Handle

Foli Height Adjustable Tables (page 83).

PH3T6601
Height Adjustable Table Base
*1130

PH3TLK6601
3rd Leg Kit
*775

PHAT2970T
Table Top
*512

PHAT2958T
Table Top
*467

PHAT2346T
Table Top
*376

Zira Sample Layouts

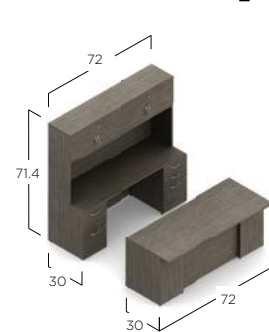

LAYOUT ZIRA EXEC1
Z3072F23+HQ Z2472T
Z16L2ES+HQ Z16L2BFS+HQ
Z72S42H+HQ

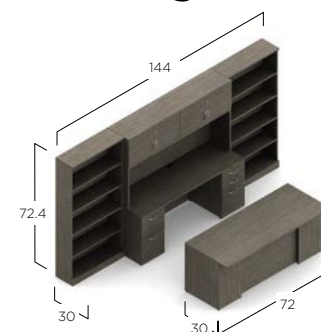

LAYOUT ZIRA EXEC2
Z3072F23+HQ Z2472T
Z16L2ES+HQ Z16L2BFS+HQ
Z72S42H+HQ ZHBC72 (2)

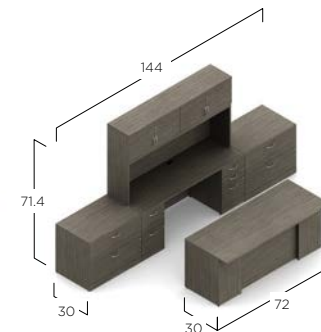

LAYOUT ZIRA EXEC3
Z3072F23+HQ Z2472T
Z16L2ES+HQ (2) Z16L2BFS+HQ
Z72S42H+HQ Z36L2ES

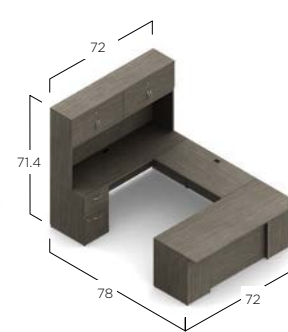

LAYOUT ZIRA EXEC4
Z3072F3R+HQ Z2448FB
Z16L2ES+HQ Z2472T
Z72S42H+HQ

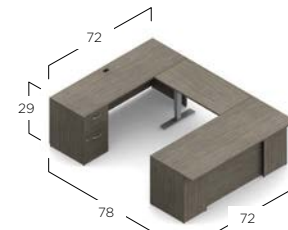

LAYOUT ZIRA EXEC5*
Z3072F3R+HQ PHAT2346T
PH3T6601 Z16L2ES+HQ
Z2472T

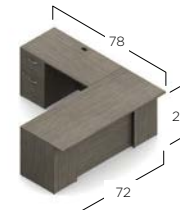

LAYOUT ZIRA MANAGER1
Z3072F3R+HQ Z16L2ES+HQ
Z2448EL

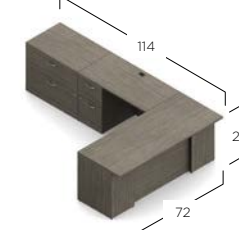

LAYOUT ZIRA MANAGER2
Z3072F3R+HQ Z16L2ES+HQ
Z2448EL Z36L2E+HQ

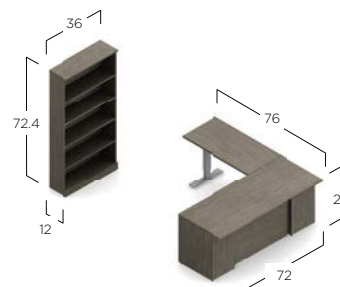

LAYOUT ZIRA MANAGER3*
Z3072F3R+HQ PHAT2346T
PH3T6601 Z16L2ES+HQ
ZHBC72

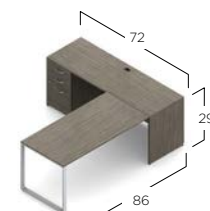

LAYOUT ZIRA MANAGER4*
Z2472T Z16L2BFS+HQ
Z3060MRR



LAYOUT ZIRA MANAGER4B*
Z2472T Z16L2BFS+HQ
PHAT2958T PH3T6601

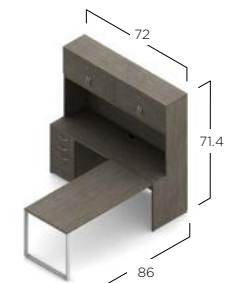

LAYOUT ZIRA MANAGER5A
Z2472T Z16L2BFS+HQ
Z3060MRR Z72S24H+HQ



LAYOUT ZIRA MANAGER5B*
Z2472T Z16L2BFS+HQ
PHAT2958T PH3T6601
Z72S24H+HQ

*Shown with Foli Height Adjustable Tables (page 83).

Genoa — LIMITED AVAILABILITY WHILE INVENTORY REMAINS

Work with ease and privacy, even in high traffic office environments. Genoa's extended corner island offers users an ergonomically correct Executive suite with ample area for computers of various sizes and shapes, in addition to everyday work materials, while providing an oversized worksurface for conferencing.

1" thick worksurfaces feature self-edges in a matching color.



Lateral files include black pulls and hardware.

File drawers accommodate letter and legal files with standard locks on all pedestals.

Available immediately in the following finish:



ACJ Absolute Acajou

Highlighted models are being phased out of the Express Program. Please inquire for availability.



Genoa Layout Shown

Absolute Acajou (ACJ)

Model	Description	List Price
G3672DP	Double Pedestal Desk	\$1201
G2036LF	2 Drawer Lateral File (\$1018 each)	\$2036
Total		\$3237

Components Shown — LIMITED AVAILABILITY WHILE INVENTORY REMAINS

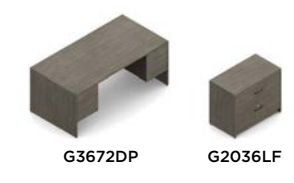

Seating shown G1 Ergo Select 7332 (page 14)

Available immediately in the following finish:

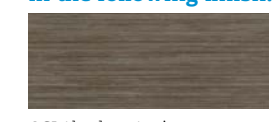

ACJ Absolute Acajou

Highlighted models are being phased out of the Express Program. Please inquire for availability.



Genoa Layout Shown

Absolute Acajou (ACJ)

Model	Description	List Price
G3060SPR	Single Pedestal Desk - RIGHT (\$842 each)	\$1684
G2040FL	Flush Return - LEFT (\$695 each)	\$1390
G3060SPL	Single Pedestal Desk - LEFT (\$842 each)	\$1684
G2040FR	Flush Return - RIGHT (\$695 each)	\$1390
Total		\$6148

Components Shown — LIMITED AVAILABILITY WHILE INVENTORY REMAINS

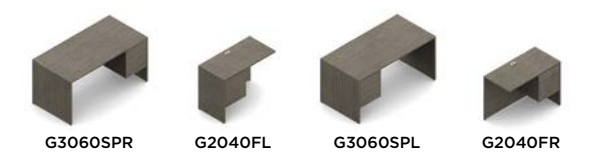

Seating shown Goal 2239-6 (page 22)

Available immediately in the following finish:

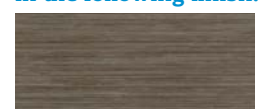

ACJ Absolute Acajou

Highlighted models are being phased out of the Express Program. Please inquire for availability.

Genoa LIMITED AVAILABILITY WHILE INVENTORY REMAINS INstock components



G3672DP
Double Pedestal Desk
72w x 36d x 29h
\$1201



GHBC72
Bookcase
36w x 12d x 72h
\$1067



G3060DP
Double Pedestal Desk
60w x 30d x 29h
\$953



G2040FL
Flush Return - LEFT
40w x 20d x 29h
\$695



G2040FR
Flush Return - RIGHT
40w x 20d x 29h
\$695



G2445SPR
Single Pedestal Desk - RIGHT
45w x 24d x 29h
\$658



G3060SPL
Single Pedestal Desk - LEFT
60w x 30d x 29h
\$842



G3060SPR
Single Pedestal Desk - RIGHT
60w x 30d x 29h
\$842



G2036LF
2 Drawer Lateral Files
36w x 20d x 29h
\$1018



G2066CK
Kneespace Credenza
66w x 20d x 29h
\$1136

Available immediately
in the following finish:

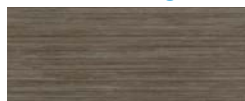

ACJ Absolute Acajou

Highlighted models are being phased out of the Express Program. Please inquire for availability.

Genoa LIMITED AVAILABILITY WHILE INVENTORY REMAINS Sample Layouts

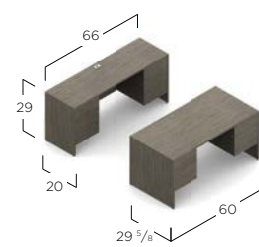

LAYOUT GEN501
G3060DP G2066CK
\$2089

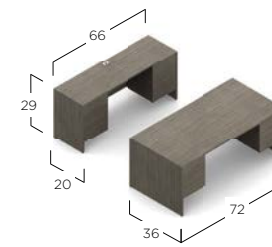

LAYOUT GEN505
G3672DP G2066CK
\$2337

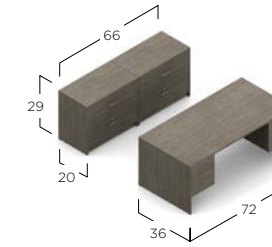

LAYOUT GEN506
G3672DP G2036LF (2)
\$3237

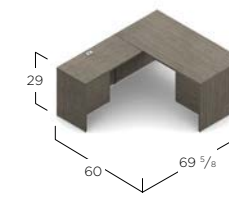

LAYOUT GEN507L
G3060SPR G2040FL
\$1537

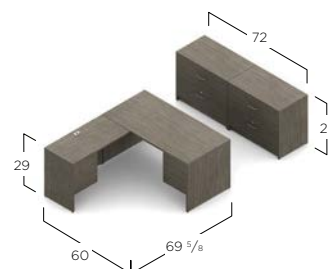

LAYOUT GEN507L
G3060SPR G2040FL
G2036LF (2)
\$3537



G3060SPR single pedestal desk - RIGHT shown with Roma seating (page 19).

Highlighted models are being phased out of the Express Program. Please inquire for availability.

Intelli Beam™ with Foli Height Adjustable Tables

Intelli Beam brings forward a new era of open plan environments.

18 x 60 Starter Extension Kit

Starter fabric extension kits include a tackable fabric panel and appropriate hardware to "stack-on" to existing starter kits (IBBSU2460S). The extension kit adds to the height of the beam, providing a greater sense of privacy, space division and some sounds absorption.

18 x 60 Add-On Extension Kit

Add-on fabric extension kits include a tackable fabric panel and appropriate hardware to "stack-on" to existing add-on kits (IBBAT2460S). The extension kit adds to the height of the beam, providing a greater sense of privacy, space division and some sounds absorption.

INstock components



IBBSU2460S
24 x 60 Starter Beam Kit
Includes Intelli Beam raceway, vertical base feed cover, power distribution housing, 17" electrical jumper cable and (2) end of run trims.
List Price ***1297**



IBBAT2460S
24 x 60 Add-On Beam Kit
Includes Intelli Beam raceway, power distribution housing and 17" electrical jumper cable.
List Price ***908**



IBSFE1860S
18 x 60 Starter Extension Kit
Fabric starter extension kit attaches on top of a starter beam kit of the same width. Must be used in conjunction with starter beam kits.
List Price ***676**



IBAFE1860S
18 x 60 Add-On Extension Kit
Fabric add-on extension kit attaches on top of an add-on beam kit of the same width. Must be used in conjunction with add-on beam kits.
List Price ***532**



IBE8RDK1A
Base Feed
A pack of four duplexes (two Circuit 1 duplexes and two Circuit A duplexes). One pack will provide duplexes for one starter beam kit OR one add-on beam kit. Duplexes snap into the power distribution housing within the Intelli Beam raceway.
List Price ***154**



IBE8FR3PB
Base Feed
Provides single power entry from floor or wall located building power supply. Must be hardwired to the building power supply by a licensed electrician.
List Price ***504**

IBE8RDK2B
A pack of four duplexes (two Circuit 2 duplexes and two Circuit B duplexes). One pack will provide duplexes for one starter beam kit OR one add-on beam kit. Duplexes snap into the power distribution housing within the Intelli Beam raceway.
List Price ***154**

Available immediately in the following textile + finish:

Tackboard - Anchorage



AN64 Cloud

Frame Finish



TUN Tungsten



Intelli Beam includes two knockouts for duplexes and one knockout for data.

The basefeed powers 4-circuits in a 2+2 electrical configuration (2 utility circuits and 2 dedicated circuits). This must be specified with an IBBSU2460S - this will then power the starter kit and any add-on kit connected to it. The base feed must be hardwired to the building power supply by a licensed electrician.

T-leg with adjustable glides

24 x 60 Starter Beam Kit

The starter kit includes everything you need to create a 2-person workstation (acts as a freestanding piece), or to start a run of more workstations. Just specify duplexes and a basefeed separately to get up and running.

24 x 60 Add-On Beam Kit

Add-on kits includes all the pieces required to expand upon the starter kit. Add one additional add-on kit for a 4-pack, two add-on kits for a 6-pack or three for an 8-pack. Add-on kits must be used with one starter kit. Specify duplexes separately.



Swap Tables

It's a simple thing done right. The right proportions. Flawless surfaces. Perfect structure. Squares or rounds at the floor with a gentle float.



6 FOOT SEATED HEIGHT CONFERENCE TABLE PACKAGE
GRB22-TUN x 2 GRT6TP
\$2105



6 FOOT BAR HEIGHT CONFERENCE TABLE PACKAGE
GRB22H41-TUN x 2 GRT6TP
\$2207



8 FOOT SEATED HEIGHT CONFERENCE TABLE PACKAGE
GRB22-TUN x 2 GRT8TP
\$2265



8 FOOT BAR HEIGHT CONFERENCE TABLE PACKAGE
GRB22H41-TUN x 2 GRT8TP
\$2367



SEATED HEIGHT TABLE PACKAGE
GRB22-TUN GRBTP36
\$1074

BAR HEIGHT TABLE PACKAGE
GRB22H41-TUN GRBTP36
\$1125

Available immediately in the following finishes:



ACJ Absolute Acajou

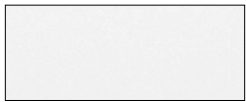



DWT White





Base Finish



TUN Tungsten

Swap Tables Components

				
GRT6TP 6' Rectangular Top 36d x 72w x 1h \$587	GRT8TP 8' Rectangular Top 36d x 96w x 1h \$747	GRBTP36 3' Round Table Top 36dia x 1h \$315	GRB22 (TUN) Seat Height Round Base \$759	GRB22H41 (TUN) Bar Height Round Base \$810

Bakhita Tables

A stable four-legged base enables seating to tuck in effortlessly. Standard and bar height tables are offered in 28" round and square tops, in Milk with Silver bases.



Bakhita 6780
Round Table
List Price **\$481**
Shown in Milk (MLK).



Bakhita 6781
Round Table, Bar Height
List Price **\$492**
Shown in Milk (MLK).



Bakhita 6785
Square Table
List Price **\$526**
Shown in Milk (MLK).



Bakhita 6786
Square Table, Bar Height
List Price **\$537**
Shown in Milk (MLK).

For Bakhita seating see page 39..

Available immediately in the following plastic finish:



MLK Milk

Foli Height Adjustable Tables

Electric height adjustment allow users to move between sitting and standing.



HEIGHT ADJUSTABLE BASE



PHAT6601
Height Adjustable Table Base
\$1130



PHATLK6601
3rd Leg Kit
\$775

HEIGHT ADJUSTABLE LAMINATE TABLE TOPS



PHAT2970T
Height Adjustable Table Top
\$512



PHAT2958T
Height Adjustable Table Top
\$467



PHAT2346T
Height Adjustable Table Top
\$376

Available immediately in the following finishes:



ACJ Absolute Acajou



DWT White



Lite Lift II Table

Lite-Lift II is ideal for applications that require a lightweight and easy to clean folding table.



MVLFRT72 - LIMITED QTY AVAILABLE
6' Rectangular Folding Table
\$339

Lite Lift II Table Features

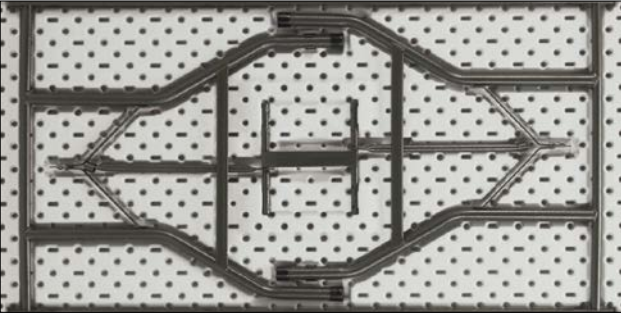

High strength 19 gauge, 1 1/8" diameter steel tubular legs have welded crossbars for durability and stability.



Folding Legs



Table tops are available in Oyster (OS) finish and aesthetically compliment all environments. UV inhibitors prevent fading.

Available immediately in the following finish:



Oyster Grey

Highlighted models are being phased out of the Express Program. Please inquire for availability.

Boardroom Tables

From small meeting rooms to large boardrooms, Global has meeting and conference tables to meet all your business needs.



GCT6RXTM - LIMITED QTY AVAILABLE
6' Rectangular Table with T-mold Edge and Slab Base
\$1050

GCT8WRXTM - LIMITED QTY AVAILABLE
8' Rectangular Table with T-mold Edge and Slab Base
\$1352

Rectangular Table Features



Rectangle Top



T-mold Edge



Slab Base

Available immediately in the following finishes:



ACJ Absolute Acajou



DWT White



Seating shown Solar 8457 (page 29)

Zira (pages 64-71)



Z3072F23 + HQ - LIMITED QTY AVAILABLE
Double Pedestal Desk
72w x 30d x 29h



Z3072F3L + HQ
Single Pedestal Desk - LEFT
72w x 30d x 29h



Z3072F3R + HQ
Single Pedestal Desk - RIGHT
72w x 30d x 29h



Z2448ER
Flush Return - RIGHT
24w x 48d x 29h
*626



Z2448EL
Flush Return - LEFT
24w x 48d x 29h
*626



Z2448FB
Flush Bridge
24w x 48d x 29h
*547



Z2472T
24" Deep Freestanding Table
72w x 24d x 29h
*808



Z3060MRR
Return w/Metal Leg - RIGHT
72w x 30d x 29h
*807



Z36L2ES + HQ - LIMITED QTY AVAILABLE
File, File Storage Shell
36w x 23.4d x 28.5h
*1283



Z16L2ES + HQ
File, File Storage Shell
16w x 23.4d x 28.5h
*708



Z16L2BFS+HQ
Box, Box, File Storage Shell
16w x 23.4d x 28.5h
*816



Z36L2E + HQ
File, File Storage Module
36w x 24d x 30h
*1576



ZHBC72
Bookcase
26w x 12d x 72.4h
*1003



Z72S42H + HQ
Open Hutch with Closed Back
72w x 15d x 42.4h
*1489

Genoa (pages 72-79)



G3672DP - LIMITED QTY AVAILABLE
Double Pedestal Desk
72w x 36d x 29h
*1201



GHBC72 - LIMITED QTY AVAILABLE
Bookcase
36w x 12d x 72h
*1067



G3060DP - LIMITED QTY AVAILABLE
Double Pedestal Desk
60w x 30d x 29h
*953



G2040FL - LIMITED QTY AVAILABLE
Flush Return - LEFT
40w x 20d x 29h
*695



G2040FR - LIMITED QTY AVAILABLE
Flush Return - RIGHT
40w x 20d x 29h
*695



G2445SPR - LIMITED QTY AVAILABLE
Single Pedestal Desk - RIGHT
45w x 24d x 29h
*658



G3060SPL - LIMITED QTY AVAILABLE
Single Pedestal Desk - LEFT
60w x 30d x 29h
*842



G3060SPR - LIMITED QTY AVAILABLE
Single Pedestal Desk - RIGHT
60w x 30d x 29h
*842



G2036LF - LIMITED QTY AVAILABLE
2 Drawer Lateral Files
36w x 20d x 29h
*1018



G2066CK - LIMITED QTY AVAILABLE
Kneespace Credenza
66w x 20d x 29h
*1136

Swap Tables (page 82)



GRT6TP
6' Rectangular Top
36d x 72w x 1h
*587



GRT8TP
8' Rectangular Top
36d x 96w x 1h
*747



GRBTP36
3' Round Table Top
36dia x 1h
*315



GRB22 (TUN)
Seat Height Round Base
*759



GRB22H41 (TUN)
Bar Height Round Base
*810

Bakhita Tables (page 83)



6780
Round Table
28.5d x 28.5w x 29.5h
*481



6781
Round Table, Bar Height
28.5d x 28.5w x 40h
*492



6785
Square Table
28.5d x 28.5w x 29.5h
*526



6786
Square Table, Bar Height
28.5d x 28.5w x 40h
*537

Foli Height Adjustable Tables (page 83)



PH3T6601
Height Adjustable Table Base
10w x 26.8h
*1130



PH3TLK6601
3rd Leg Kit
10d x 26.8h
*775



PHAT2970T
Height Adjustable Table Top
70w x 29d x 1h
*512



PHAT2958T
Height Adjustable Table Top
58w x 29d x 1h
*467



PHAT2346T
Height Adjustable Table Top
46w x 23d x 1h
*376

Boardroom Tables (pages 84-85)



GCT6RXTM - LIMITED QTY AVAILABLE
6' Rectangular Table with T-mold Edge and Slab Base
36d x 72w x 29h
*1050



GCT8WRXTM - LIMITED QTY AVAILABLE
8' Rectangular Table with T-mold Edge and Slab Base
48d x 96w x 29h
*1352



MVFRT72 - LIMITED QTY AVAILABLE
6' Rectangular Folding with 30d x 72w x 29.25h
*339

filing + storage



1900P Filing 1936P-2F12 (page 90) 2 Drawer Lateral File, 1936P-4F12 (page 90) 4 Drawer Lateral File and 1936P-5F12 (page 90) 5 Drawer Lateral File shown in Designer White (DWT) finish.

Filing + Storage

Global provides a variety of innovative and cost effective "Storage Solutions" that can react to your daily demands.



9336P-2F1H
36" Wide 2 Drawer Lateral File
36w x 18d x 27.125h
Shown in Designer White (DWT).
\$821

9336P-3F1H
36" Wide 3 Drawer Lateral File
36w x 18d x 40.5h
Shown in Designer White (DWT).
\$1090

9336P-4F1H
36" Wide 4 Drawer Lateral File
36w x 18d x 54h
Shown in Designer White (DWT).
\$1367

9336P-5F1H
36" Wide 5 Drawer Lateral File
36w x 18d x 65.25h
Shown in Designer White (DWT).
\$1722

9342P-2F1H (not shown) - LIMITED QTY AVAILABLE
42" Wide 2 Drawer Lateral File
42w x 18d x 27.125h
\$926

9342P-3F1H (not shown) - LIMITED QTY AVAILABLE
42" Wide 3 Drawer Lateral File
42w x 18d x 40.5h
\$1206

9342P-4F1H (not shown) - LIMITED QTY AVAILABLE
42" Wide 4 Drawer Lateral File
42w x 18d x 54h
\$1559

9342P-5F1H (not shown) - LIMITED QTY AVAILABLE
42" Wide 5 Drawer Lateral File
42w x 18d x 65.25h
\$1942



1936P-2F12 - LIMITED QTY AVAILABLE
2 Drawer Lateral File
36w x 19.25d x 27.14h
Shown in Designer White (DWT).
\$806

1936P-4F12 - LIMITED QTY AVAILABLE
4 Drawer Lateral File
36w x 19.25d x 51.89h
Shown in Designer White (DWT).
\$1281

1936P-5F12 - LIMITED QTY AVAILABLE
5 Drawer Lateral File
36w x 19.25d x 66.39h
Shown in Designer White (DWT).
\$1517

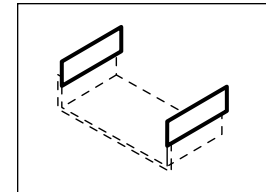

EDPS
Side Adapters
\$44

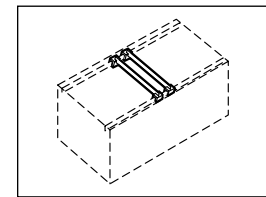

FBB
Front-to-Back Hanging File Bars
\$24

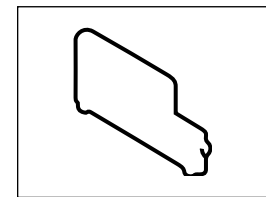

PD
Plate Dividers
\$35

Available immediately in the following finishes:



BLK Black **DWT** Designer White **LGR** Light Grey



25-201 - LIMITED QTY AVAILABLE
25"D 2 Drawer Vertical File with lock - Letter
15.15w x 25d x 29h
Shown in Designer White (DWT).
\$373

25-401 - LIMITED QTY AVAILABLE
25"D 4 Drawer Vertical File with lock - Letter
15.15w x 25d x 52h
Shown in Designer White (DWT).
\$494

25-501 - LIMITED QTY AVAILABLE
25"D 5 Drawer Vertical File with lock - Letter
15.15w x 25d x 64.25h
Shown in Designer White (DWT).
\$718

9336-S72L
Storage Cabinet
36w x 18d x 72h
Shown in Designer White (DWT).
\$700

9336P-S72L
Storage Cabinet (Looped Full Pull)
36w x 18d x 72h
Shown in Designer White (DWT).
\$700

25-251 (not shown) - LIMITED QTY AVAILABLE
25"D 2 Drawer Vertical File with lock - Legal
18.15w x 25d x 29h
\$434

25-451 (not shown) - LIMITED QTY AVAILABLE
25"D 4 Drawer Vertical File with lock - Legal
18.15w x 25d x 52h
\$563



19FP23BBF - LIMITED QTY AVAILABLE
Box/Box/File Pedestal
15w x 22.625d x 27.625h
Shown in Designer White (DWT).
\$449

19FP23FF - LIMITED QTY AVAILABLE
File/File Pedestal
15w x 22.625d x 27.625h
Shown in Designer White (DWT).
\$449

Available immediately in the following finishes:



BLK Black **DWT** Designer White **LGR** Light Grey



File Buddy 1105
Pneumatic Swivel Stool
Dimensions: 14dia x 16.25h - 21.25h
Shown in Allante FRee, Ink (A16F).
\$388

Available immediately in the following textile:

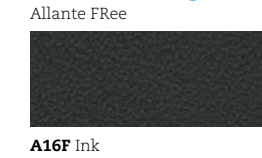

A16F Ink

OfficestoGo

OfficestoGo.com

Office Furniture

at Exactly the Right Price.



OfficestoGo Work + Task Seating



OTG11685B (pictured left) - page 103



OTG2913 page 96



OTG11710 page 96



OTG2803 page 99



OTG3191 page 100



OTG11920B page 113



OTG11653 page 104

OTG11685B (page 103) shown in Carrera Zest (CE84) and Superior Laminate Desking shown in Autumn Walnut (AWL) finish.



OTG2913
Luxhide Multi-Function List Price **\$792**



OTG11710
Multi-Function List Price **\$707**



OTG3101 - LIMITED QTY AVAILABLE
Mesh Back Synchro-Tilter List Price **\$707**



OTG3103 - LIMITED QTY AVAILABLE
Mesh Back Multi-Function List Price **\$744**



Key Features



Back height adjustment via internal ratchet
Available immediately in the following textile:
Luxhide



BL20 Black



Multi-Function mechanism with seat depth adjustment



See pages 172-175 for more information.

For specifications and dimensions see page 161.



Key Features



Back height adjustment via internal ratchet
Available immediately in the following textile:
Quilt



QL10 Black



Width and height adjustable arms

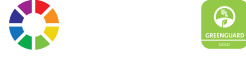

See pages 172-175 for more information.

For specifications and dimensions see page 161.



Key Features



Height and depth adjustable lumbar support
Available immediately in the following textile:
Luxhide



BL20 Black



Multiple position tilt lock



See pages 172-175 for more information.

For specifications and dimensions see page 158.



Key Features



Height and depth adjustable lumbar support
Available immediately in the following textile:
Mesh



Black Mesh fabric seat



Multi-Function mechanism with seat depth adjustment



See pages 172-175 for more information.

For specifications and dimensions see page 159.



OTG2801 (pictured left)
Mesh Synchro-Tilter with upholstered seat List Price **\$632**



OTG2803
Mesh Multi-Function with upholstered seat List Price **\$659**



OTG2821
Mesh Synchro-Tilter with mesh seat List Price **\$792**



Key Features



Multi-Function mechanism

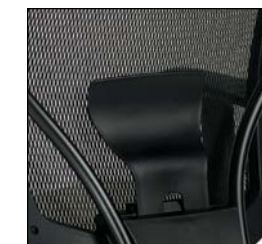

Height adjustable lumbar support

Available immediately in the following textile:

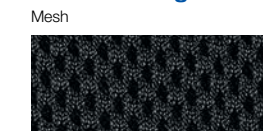

Black Mesh fabric seat (OTG2801)



See pages 172-175 for more information.



For specifications and dimensions see page 158.

Available immediately in the following textile:

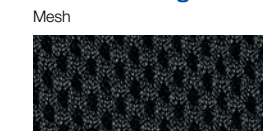

Black Mesh fabric seat



See pages 172-175 for more information.



For specifications and dimensions see page 158.



OTG11325B
Mesh Back Synchro-Tilter
List Price **\$605**



OTG3191
Mesh Back Synchro-Tilter
List Price **\$578**



OTG11692
Mesh Back Tilter
List Price **\$482**



OTG11980B
Mesh Back Synchro-Tilter
List Price **\$546**



Key Features



Multiple adjustment arm



Sliding seat mechanism

Available only in the following textile:

Quilt



QL10 Black



For specifications and dimensions see page 158.



Key Features



Back height adjustment via internal ratchet



Height and width adjustable arms

Available immediately in the following textile:

Luxhide



BL20 Black



See pages 172-175 for more information.

For specifications and dimensions see page 158.



Key Feature



Seat depth adjustment

Available immediately in the following textile:

Luxhide



BL20 Black



See pages 172-175 for more information.

For specifications and dimensions see page 157.



Key Feature



Height adjustable arms with polyurethane armrests

Available immediately in the following textile:

Quilt



QL10 Black



See pages 172-175 for more information.

For specifications and dimensions see page 158.



OTG11685B
Mesh High Back Synchro-Tilter
List Price **\$520**



OTG11686B
Mesh Mid Back Synchro-Tilter
List Price **\$462**

Available immediately
in the following textile:



Black Mesh fabric seat



2DAY SHIP
MORE TEXTILES

See pages 172-175 for more information.

For specifications and dimensions see pages 157-158.



OTG11653
Multi-Function List Price **\$605**



Key Features



Pivot arm rest



Manual back height adjustment

Available immediately in the following textile:
Quilt



QL10 Black



See pages 172-175 for more information.

For specifications and dimensions see page 161.



OTG12110B
Mesh Back Luxhide Tilter List Price **\$467**



Key Feature



Lumbar pad with flexible support

Available only in the following textile:
Luxhide



BL20 Black



For specifications and dimensions see page 157.



OTG11652
High Back Tilter List Price **\$380**



Key Features



Depth adjustable lumbar support



Height adjustable arms

Available immediately in the following textile:
Quilt



QL10 Black



See pages 172-175 for more information.

For specifications and dimensions see page 160.



OTG11651
Low Back Tilter List Price **\$354**



Key Features



Depth adjustable lumbar support



Height adjustable arms

Available immediately in the following textile:
Quilt



QL10 Black



See pages 172-175 for more information.

For specifications and dimensions see page 160.



OTG11641B
Mesh High Back Synchro-Tilter List Price **\$435**



OTG11647B
Mesh Mid Back Synchro-Tilter List Price **\$393**



OTG11642B
Mesh Back Task
Armless
List Price **\$276**



OTG11642B
Mesh Back Task with
Adjustable Height Arm Kit
(OTG11620)
List Price **\$372**



OTG11642B
Mesh Back Task with Drafting
Stool Kit (OTG11600)
List Price **\$499**



OTG11642B
Mesh Back Task with Drafting
Stool Kit (OTG11600) and
Adjustable Height Arm Kit
(OTG11620)
List Price **\$595**



OTG11620
Adjustable Height Arm Kit
List Price **\$96**



OTG11600
Drafting Stool Kit
List Price **\$223**

Available only in the following textile:



Black Mesh fabric seat



For specifications and dimensions see pages 156-157, 171.



OTG11516B
Mesh High Back Synchro-Tilter
List Price **\$483**



OTG11514B
Mesh Mid Back Tilter
List Price **\$345**



OTG11865B - LIMITED QTY AVAILABLE
Mesh Back Tilter
List Price **\$488**



OTG12112B
Mesh Back Tilter
List Price **\$387**



OTG11769B
Mesh Back Multi-Function
List Price **\$583**



OTG11769B Key Features



Styled back design



Width and height adjustable arms



Seat sliding mechanism



Back height adjustment via internal ratchet



Multi-Tilter mechanism

Available only in the following textile:

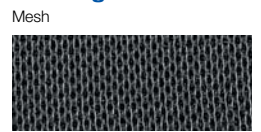

Black Mesh fabric seat

For specifications and dimensions see pages 156-158.



Key Features



Stylish wing back design

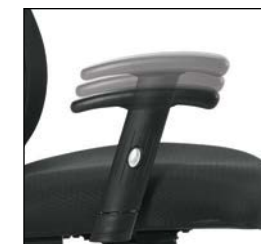

Height adjustable arms with titanium accents

Available only in the following textile:



QL10 Black

For specifications and dimensions see page 157.



Key Features



Stylish back design



Height adjustable arms

Available only in the following textile:



BL20 Black

For specifications and dimensions see page 156.



OTG11950B
Multi-Function List Price **\$467**



Key Features



Back height adjustment via internal ratchet



Seat depth adjustment

Available only in the following textile:
Quilt



QL10 Black



For specifications and dimensions see page 161.



OTG10904B
Mesh Back Synchro-Tilter List Price **\$477**



Key Features



Polished aluminum base



Synchro-tilt mechanism with multiple position locks

Available only in the following textile:
Mesh

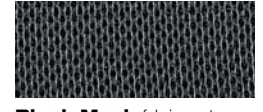

Black Mesh fabric seat



For specifications and dimensions see page 157.



OTG11631B
Multi-Function List Price **\$446**



Key Features



Height adjustable lumbar support



Seat and back angle adjustments

Available only in the following textile:
Quilt



QL10 Black



For specifications and dimensions see page 160.



OTG11328B - LIMITED QTY AVAILABLE
Mesh Back Tilter List Price **\$440**



Key Features



Fixed arms



Sliding seat mechanism

Available only in the following textile:
Quilt



QL10 Black



For specifications and dimensions see page 157.



OTG11920B
Mesh High Back Tilter
List Price **\$414**



OTG11921B
Mesh Mid Back Tilter
List Price **\$361**



OTG11922B
Mesh Mid Back Task - Armless
List Price **\$303**



OTG11924 - LIMITED QTY AVAILABLE!
Adjustable Height Arm Kit
List Price **\$85**
for use on OTG11922B and OTG11923B

Available only in the following textile:

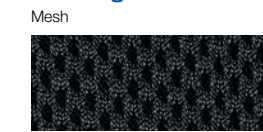

Black Mesh fabric seat



OTG11600
Drafting Stool Kit
List Price **\$223**



OTG11923B - LIMITED QTY AVAILABLE!
Mesh Back Guest - Armless
List Price **\$303**



For specifications and dimensions see pages 156, 166.



OTG11715B - LIMITED QTY AVAILABLE!
Synchro-Tilter List Price **\$414**



Key Feature



Decorative outer back shell

Available only in the following textile:

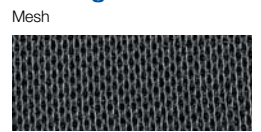

Black Mesh fabric seat and back



For specifications and dimensions see page 160.



OTG11320B
Mesh Back Tilter List Price **\$371**



Key Feature



Decorative outer back shroud

Available only in the following textile:



Black Mesh fabric seat



For specifications and dimensions see page 156.



OTG11850B
Tilter List Price **\$366**



Available only in the following textile:



QL10 Black



For specifications and dimensions see page 160.



OTG11612B
Tilter List Price **\$345**



Available only in the following textile:

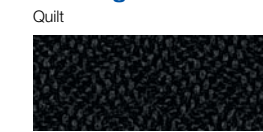

QL10 Black



For specifications and dimensions see page 160.



OTG11642B
Mesh Back Task - Armless
List Price **\$276**



OTG11922B
Mesh Back Task - Armless
List Price **\$303**



OTG11343B
Air Mesh Task
List Price **\$223**



OTG11650
Task - Armless
List Price **\$273**



OTG11620
Adjustable Height Arm Kit
List Price **\$96**

OTG11600
Drafting Stool Kit with 10" Gas Cylinder
List Price **\$223** (kit only)
List Price **\$276** (chair only)
Total As Shown **\$499**



OTG11924 - LIMITED QTY AVAILABLE!
Adjustable Height Arm Kit
List Price **\$85**

OTG11600
Drafting Stool Kit with 10" Gas Cylinder
List Price **\$223** (kit only)
List Price **\$303** (chair only)
Total As Shown **\$526**



OTG11620
Adjustable Height Arm Kit
List Price **\$96**

OTG11600
Drafting Stool Kit with 10" Gas Cylinder
List Price **\$223** (kit only)
List Price **\$223** (chair only)
Total As Shown **\$446**



OTG11620
Adjustable Height Arm Kit
List Price **\$96**

OTG11600
Drafting Stool Kit with 10" Gas Cylinder
List Price **\$223** (kit only)
List Price **\$273** (chair only)
Total As Shown **\$494**

Available only in the following textile:

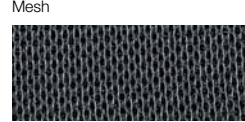

Black Mesh fabric seat



For specifications and dimensions see page 156.

Available only in the following textile:

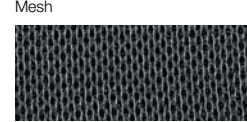

Black Mesh fabric seat



For specifications and dimensions see page 156.

Available only in the following textile:

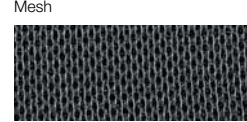

Black Mesh fabric seat and back



For specifications and dimensions see page 160.

Available immediately in the following textile:



QL10 Black



See pages 172-175 for more information.

For specifications and dimensions see page 160.



OfficestoGo Conference + Management Seating



OTG11730B (pictured left) - page 125



OTG11648B page 120



OTG2700 page 123



OTG11786B page 129



OTG13026B page 135



OTG11657B page 127



OTG10902B page 133

OTG11730B (page 125) shown in Fusion Cobalt (FU83) and Superior Laminate Desking shown in Autumn Walnut (AWL) finish.



OTG11648B
Segmented Cushion Tilter
List Price **\$610**



Key Features



Padded armrests can be removed to achieve a sleek look

Available only in the following textile:

Luxhide



BL20 Black



Segmented cushion back



For specifications and dimensions see page 164.



OTG11858B
Segmented Cushion Tilter
List Price **\$509**



Key Features



Padded armrests

Available only in the following textile:

Luxhide



BL20 Black



For specifications and dimensions see page 163.



OTG11300B
Tilter with Wood Arms and Base
List Price **\$583**



Key Feature



Decorative wood arms and base

Available only in the following textile:

Luxhide



BL20 Black



For specifications and dimensions see page 164.



OTG11618B
Tilter
List Price **\$515**



Key Feature



Integrated headrest

Available only in the following textile:

Luxhide



BL20 Black



For specifications and dimensions see page 163.



OTG2700 (page 123) shown in Waterfall Imagine (WA44) with Superior Laminate Desking shown in Artisan Grey (AGL) finish.



OTG2700
High Back Tilter

List Price **\$562**



OTG2700 Side View



OTG2701
Mid Back Tilter

List Price **\$541**



OTG2782
Guest Chair

List Price **\$428**

Available immediately
in the following textile:

Luxhide



BL20 Black



See pages 172-175 for more information.



For specifications and dimensions see pages 164, 167.



OTG11730B
High Back Tilter

List Price **\$552**



OTG11732
High Back Tilter - Armless

NOW STOCKED

List Price **\$557**



OTG11734B
Mid Back Tilter

List Price **\$519**



OTG11735
Mid Back Tilter - Armless

NOW STOCKED

List Price **\$519**

Available immediately
in the following textiles:

Luxhide



BL20 Black

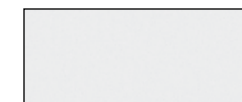

BL28 White (OTG11730B only)



2 DAY SHIP
MORE TEXTILES

See pages 172-175 for more information



For specifications and dimensions see pages 163-164.



OTG2788
Tilter
List Price **\$498**



Available immediately in the following textile:
Luxhide



BL20 Black



See pages 172-175 for more information.



For specifications and dimensions see page 163.



OTG11790B - LIMITED QTY AVAILABLE*
Mesh Back Knee-Tilter
List Price **\$536**



Key Features



Knee-tilt mechanism



Multiple position tilt lock

Available only in the following textile:
Mesh

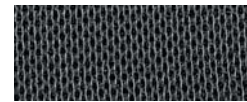

Black Mesh fabric seat



For specifications and dimensions see page 162.



OTG11657B
Mesh Back Tilter
List Price **\$446**



OTG11657B Side View

Available only in the following textile:

Mesh

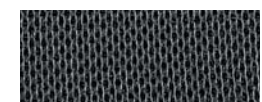

Black Mesh fabric seat



For specifications and dimensions see page 162.

Key Features



Polished aluminum arm with removable arm pad



Chrome steel base

OTG11657B Mesh Back Tilter shown with SL9544RS Racetrack Boardroom Table in Artisan Grey Laminate AGL finish (page 198).





OTG11786B - LIMITED QTY AVAILABLE
Tilter List Price *546



Key Feature



Chrome steel base

Available immediately in the following textile:
Luxhide



BL20 Black



2DAY SHIP MORE TEXTILES

See pages 172-175 for more information.



For specifications and dimensions see page 164.



OTG11975B
Tilter

List Price **\$403**



Key Feature



Padded armrests

Available only in the following textile:

Luxhide



BL20 Black



For specifications and dimensions see page 163.



OTG11617B
Tilter

List Price **\$393**



Key Features



Padded armrests

Available only in the following textile:

Luxhide



BL20 Black



For specifications and dimensions see page 163.



OTG11782B
Tilter

List Price **\$356**



Key Feature



Molded arm with upholstered inset cap

Available only in the following textile:

Luxhide



BL20 Black



For specifications and dimensions see page 163.



OTG11776B
Tilter

List Price **\$281**



Key Feature



Stylish Polyurethane armrests

Available only in the following textile:

Luxhide



BL20 Black



For specifications and dimensions see page 163.



OTG11750B
Mesh Back Tilter
List Price **\$356**



Key Feature



Stylish mesh back pattern

Available only in the following textile:



Black Mesh fabric seat



For specifications and dimensions see page 162.



OTG10901B - LIMITED QTY AVAILABLE
Mesh Back Tilter
List Price **\$265**



Key Feature



Stylish chrome accent on outer back

Available only in the following textile:



Black Mesh fabric seat



For specifications and dimensions see page 162.



OTG10902B
Mesh Back Tilter
List Price **\$265**



Key Feature

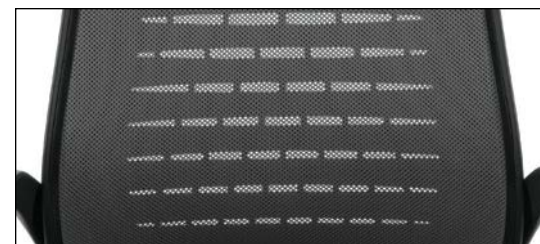

Stylish mesh back pattern

Available only in the following textiles:



Grey Mesh back

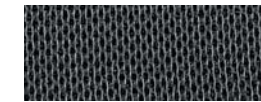

Black Mesh fabric seat



For specifications and dimensions see page 162.



OTG10900B
Mesh Back Tilter
List Price **\$239**



Key Feature



Stylish Polyurethane molded armrests

Available only in the following textiles:



Grey Mesh back

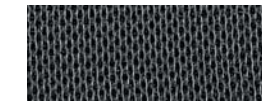

Black Mesh fabric seat



For specifications and dimensions see page 162.



OTG13026B
Mesh Low Back Tilter

List Price **\$350**



OTG13026B Side View



OTG13050B (Shown with Casters - included)
Mesh Armchair List Price **\$350**



OTG13050B (Shown with Glides - included)
Mesh Armchair List Price **\$350**



OTG13050BT (Shown on OTG13050B)
Tablet only List Price **\$106**

Available only in the following textile:

Luxhide



BL20 Black



For specifications and dimensions see pages 163, 166.



OTG11600
Drafting Stool Kit with 10" Gas Cylinder
List Price **\$223** (stool kit only)
List Price **\$276** (chair only - OTG11642B)
Total As Shown **\$499**



OTG11600
Drafting Stool Kit with 10" Gas Cylinder
List Price **\$223** (stool kit only)
List Price **\$303** (chair only - OTG11922B)
Total As Shown **\$526**



OTG11600
Drafting Stool Kit with 10" Gas Cylinder
List Price **\$223** (stool kit only)
List Price **\$223** (chair only - OTG11343B)
Total As Shown **\$446**



OTG11600
Drafting Stool Kit with 10" Gas Cylinder
List Price **\$223** (stool kit only)
List Price **\$273** (chair only - OTG11650B)
Total As Shown **\$494**

OTG11620
Adjustable Height Arm Kit
List Price **\$96**



Available only in the following textile:

Mesh

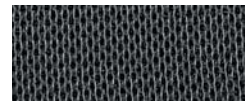

Black Mesh fabric seat



For specifications and dimensions see page 171.

OTG11924 - LIMITED QTY AVAILABLE
Adjustable Height Arm Kit
List Price **\$85**



Available only in the following textile:

Mesh

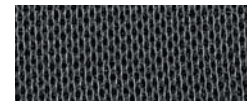

Black Mesh fabric seat



For specifications and dimensions see page 171.

OTG11620
Adjustable Height Arm Kit
List Price **\$96**



Available only in the following textile:

Mesh

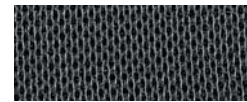

Black Mesh fabric seat and back



For specifications and dimensions see page 171.

OTG11620
Adjustable Height Arm Kit
List Price **\$96**



Available immediately in the following textile:

Quilt



QL10 Black seat and back

2DAY SHIP MORE TEXTILES

See pages 172-175 for more information.

For specifications and dimensions see page 171.



Model	Description	List Price
OTG5001NA	Armless Single Seat (\$621 each)	\$1230
OTG5002	Single Arm - Reversible (\$177 each)	\$350
OTG5003	Cushion Bridge	\$241
Total		\$1819



Model	Description	List Price
OTG5001NA	Armless Single Seat (\$621 each)	\$1230
OTG5002	Single Arm - Reversible	\$177
OTG5002C	Single Arm - Center	\$177
OTG5011	Pair of Connecting Brackets	\$49
OTG5004	Single Bench	\$402
Total		\$2026

Instock components - LIMITED AVAILABILITY WHILE INVENTORY REMAINS

					
OTG5001NA* Armless Single Seat \$621 <i>*Not UPSable</i>	OTG5002 Single Arm - Reversible \$177	OTG5002C Single Arm - Center \$177	OTG5003 Cushion Bridge \$241	OTG5004 Single Bench \$402	OTG5011 Pair of Connecting Brackets \$49/pair

Available immediately in the following textile:

Luxhide  BL20 Black	Finish  Chrome Frame
---	--

These models are available immediately from stock in Luxhide Black (BL20), but are available in additional textiles. Additional textiles would be subject to "standard" lead times. See page 204-207 for available textiles.

For specifications and dimensions see page 170.



OTG13007 (page 141) shown in Hudson Meadow (HD06), OTG13008 shown in Hudson Grey (HD08) and OTG13010 shown in Hudson Cerulean (HD14).



Model	Description	List Price
OTG13012	Square Modular Ottoman	\$386
OTG13010	V-Shaped Modular Ottoman (\$610 each)	\$1210
OTG13011	Rectangular Modular Ottoman (\$498 each)	\$986
OTG13009	Wedge Ottoman	\$471
OTG13008	Half Round Ottoman	\$455
OTG13007	Round Ottoman	\$354
Total		\$3846



Model	Description	List Price
OTG13012	Square Modular Ottoman (\$386 each)	\$764
OTG13010	V-Shaped Modular Ottoman (\$610 each)	\$1210
OTG13011	Rectangular Modular Ottoman (\$498 each)	\$986
Total		\$2960



Model	Description	List Price
OTG13012	Square Modular Ottoman (\$386 each)	\$764
OTG13010	V-Shaped Modular Ottoman (\$610 each)	\$2420
Total		\$3184

INstock components



OTG13012
Square Modular Ottoman
\$386



OTG13011
Rectangular Modular Ottoman
\$498



OTG13010
V-Shaped Modular Ottoman
\$610



OTG13007
Round Ottoman
\$354



OTG13008
Half Round Ottoman
\$455



OTG13009
Wedge Shaped Ottoman
\$471

Optional Casters

C107SET4
Set of four casters for use on OTG13011, OTG13012, OTG13008 and OTG13009 \$62

C107RSET4
Set of four hard floor casters for use on OTG13011, OTG13012, OTG13008 and OTG13009 \$110

C107SET5
Set of five casters for use on OTG13010 \$74

C107RSET5
Set of five hard floor casters for use on OTG13010 \$134

C107SET6
Set of six casters for use on OTG13007 \$90

C107RSET6
Set of six hard floor casters for use on OTG13007 \$161

Available immediately in the following textiles:

Hudson



HD08 Grey



HD11 Carbon



These models are available immediately from stock in Hudson Grey (HD08) and Hudson Carbon (HD11), but are available in additional textiles. Additional textiles would be subject to "standard" lead times. See page 172-175 for available textiles.

For specifications and dimensions see page 170.



OfficestoGo Stack, Nesting + Guest Seating



OTG11340B (pictured left) - page 150



OTG2809 page 144



OTG2782 page 145



OTG3918 page 147



OTG11820B page 145



OTG13050B page 147



OTG1220B page 155

OTG11341B (page 150) shown in Carrera Chili (CE92) and Flip Top Training Tables shown in Autumn Walnut (AWL) tops and Tungsten base finish.



OTG2809
Mesh Back Guest Chair List Price **\$487**



Key Feature



Molded armrests

Available immediately in the following textile:



Black Mesh fabric seat



See pages 172-175 for more information.



OTG11512B
Mesh Back Guest Chair List Price **\$356**



Key Feature



Stylish back detail

Available only in the following textile:



Black Mesh fabric seat



For specifications and dimensions see page 166.



OTG2782
Guest Chair List Price **\$428**



Available immediately in the following textile:

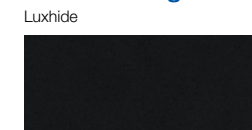

BL20 Black



See pages 172-175 for more information.



For specifications and dimensions see page 167.



OTG11820B(CX)
Wood Guest Chair - Cordovan Finish List Price **\$456**



OTG11820B(TH)
Wood Guest Chair - Toffee Finish List Price **\$456**

Available only in the following textile/finishes:

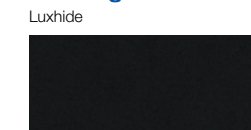

BL20 Black



CX Cordovan **TH** Toffee



For specifications and dimensions see page 167.



OTG13050B (Shown with Casters - included)
Mesh Armchair List Price ***350**



OTG13050B (Shown with Glides - included)
Mesh Armchair List Price ***350**



OTG13050BT (Shown on OTG13050B)
Tablet only List Price ***106**

Available only in the following textile:

Luxhide



BL20 Black



For specifications and dimensions see pages 156, 166, 171.



OTG3918B
Guest Chair List Price ***318**



OTG11740B
Plastic Back Guest List Price ***318**



Can be stacked up to 5 high on the floor

Key Feature



Polyurethane arms

Available only in the following textile:

Quilt



QL10 Black



For specifications and dimensions see page 166.

Key Feature

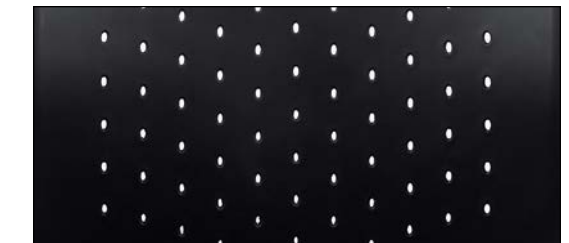

Perforated back detail

Available only in the following finish + textile:

Polypropylene

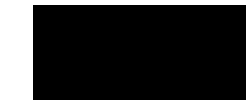

Black Polypropylene

Mesh

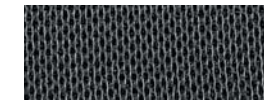

Black Mesh fabric seat



For specifications and dimensions see page 166.



OTG11923B - LIMITED QTY AVAILABLE
Mesh Back Guest Chair - Armless List Price **\$303**

OTG11923B Side View



OTG11920B
High Back Mesh Back Tilter
List Price **\$414**



OTG11921B
Mid Back Mesh Back Tilter
List Price **\$361**



OTG11922B
Mid Back Mesh Back Task - Armless
List Price **\$303**

OTG11924 - LIMITED QTY AVAILABLE
Adjustable Height Arm Kit
List Price **\$85**



Available only in the following textile:

Mesh

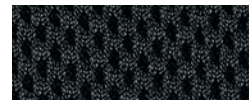

Black Mesh fabric seat

For specifications and dimensions see pages 156, 166, 171.



OTG3915B
Luxhide Guest Chair

List Price **\$324**



OTG11770BES - Espresso Finish
Luxhide Guest Chair with Wood Accents

List Price **\$366**



OTG11770BCX - Cordovan Finish
Luxhide Guest Chair with Wood Accents

List Price **\$366**

Available only in the following textile:

Luxhide



BL20 Black



For specifications and dimensions see page 166.

Available only in the following textile/finishes:

Luxhide



BL20 Black

Finishes



CX Cordovan



ES Espresso



For specifications and dimensions see page 167.



OTG11892
Guest Chair List Price **\$364**



Available immediately in the following textile:



QL10 Black



2DAY SHIP
MORE TEXTILES

See pages 172-175 for more information.



For specifications and dimensions see page 167.



OTG11341B
Armless Mesh Back Flip Seat Nesting Chair List Price **\$377**



OTG11340B*
Mesh Back Flip Seat Nesting Chair (nested) List Price **\$424**
**Not UPSable*

Available immediately in the following textile:



Black Mesh fabric seat



For specifications and dimensions see page 169.



OTG11760B
Mesh Guest Chair List Price **\$276**



Available immediately in the following textile:



Black Mesh fabric seat



For specifications and dimensions see page 166.



OTG11761B
Armless Mesh Guest Chair with Casters List Price **\$260**



Available only in the following textile:



Black Mesh fabric seat



For specifications and dimensions see page 166.



OTG11703
Stack List Price **\$241**

Can be stacked up to 4 high on the floor or dolly.



OTG11697
Armless Stack List Price **\$182**

Can be stacked up to 13 high on the floor or 15 high on dolly.



OTG2748
Armless Stack List Price **\$193**

Can be stacked up to 4 high on the floor or dolly.



OTG11934
Armless Stack List Price **\$150**



OTG11704
Armless Stack List Price **\$214**



OTG11698 - LIMITED QTY AVAILABLE
Dolly List Price **\$321**

Dolly can accommodate 15 stacked chairs!



Can be stacked up to 4 high on the floor.



OTG11705 - LIMITED QTY AVAILABLE
Dolly List Price **\$156**

Dolly can accommodate 10 stacked chairs!

OTG11706 - LIMITED QTY AVAILABLE
Dolly List Price **\$268**
Dolly can accommodate 4 stacked chairs!

GC3010 - LIMITED QTY AVAILABLE
Dolly List Price **\$250**
Dolly can accommodate 4 stacked chairs!

Available immediately in the following textile:

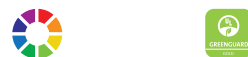

QL10 Black



See pages 172-175 for more information.

Available immediately in the following textile:



QL10 Black



See pages 172-175 for more information.

Available immediately in the following textile:



QL10 Black



See pages 172-175 for more information.

Available immediately in the following textile:



QL10 Black



See pages 172-175 for more information.



OTG11310B
Medium Density stacking
Not UPSable List Price **\$170**

Can be stacked up to 8 high on the floor or 24 high on dolly.



OTG11310B Side View



Shown stacked 8 high on floor

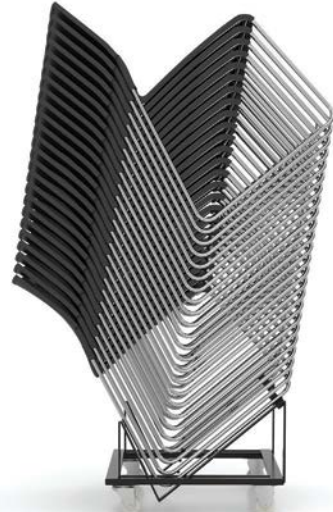

Shown stacked 24 high on optional dolly (OTG11311B)



OTG11311B - LIMITED QTY AVAILABLE
Dolly
List Price **\$308**

Dolly can accommodate 24 stacked chairs!



OTG11312 - LIMITED QTY AVAILABLE
Connectors - Use 2 for each connection
List Price **\$27**



OTG11313
Glides (priced per pair)
List Price **\$22**



Available only in the following finish:

Polypropylene



Black

For specifications and dimensions see page 168.



OTG1220B
Stack List Price **\$202**

Can be stacked up to 5 high on the floor.



OTG1221B
Armless Stack List Price **\$186**

Can be stacked up to 5 high on the floor.

Available only in the following finish:

Polypropylene



Black

For specifications and dimensions see page 168.



OTG11700
Plastic Back Stack List Price **\$193**

Can be stacked up to 12 high on the floor or dolly.



OTG11701 - LIMITED QTY AVAILABLE
Dolly
List Price **\$209**

Dolly can accommodate 12 stacked chairs!

Available only in the following finish:

Polypropylene



Black

For specifications and dimensions see page 168.





OTG11642B - pages 107, 116
 Mesh Back Task - Armless
 Dimensions: 19w x 20d x 37h
 Ergonomic Features: C, M, N, S

- Black mesh back with breathable Black mesh fabric seat
- Pneumatic seat height adjustment
- Armless design - height adjustable arms (OTG11620) are available
- Swivel task mechanism
- Twin wheel carpet casters
- Drafting stool kit (OTG11600) available (pages 107, 116, 117, 136, 137)
- Soft casters (OTG10700) are available (page 171)

List Price **\$276**



OTG11922B - pages 113, 116, 148
 Mesh Back Task - Armless
 Dimensions: 20w x 23d x 38h
 Ergonomic Features: C, M, N

- Mid back design
- Black mesh back with breathable Black air mesh fabric seat
- Pneumatic seat height adjustment
- Armless design - height adjustable arms (OTG11924) are available
- Swivel task mechanism with single position tilt lock and tilt tension adjustment
- Twin wheel carpet casters
- Drafting stool kit (OTG11600) available (pages 107, 116, 117, 136, 137)
- Soft casters (OTG10701) are available (page 171)

List Price **\$303**



OTG11514B - page 108
 Mid Back Mesh Back Tilter
 Dimensions: 25w x 23d x 37h
 Ergonomic Features: A, B, C, H, M, N, S

- Black mesh back with breathable Black air mesh fabric seat
- Pneumatic seat height adjustment
- Height adjustable arms with polyurethane armrests
- Single position tilt lock with tilt tension adjustment
- Swivel task mechanism with single position tilt lock and tilt tension adjustment
- Twin wheel carpet casters
- Soft casters (OTG10700) are available (page 171)

List Price **\$345**



OTG11921B - pages 113, 148
 Mid Back Mesh Back Tilter
 Dimensions: 25w x 23d x 39h
 Ergonomic Features: A, B, C, H, M, N, S

- Mid back design
- Black mesh back with breathable Black air mesh fabric seat
- Pneumatic seat height adjustment
- Height adjustable arms with polyurethane armrests
- Tilter mechanism with single position tilt lock and tilt tension adjustment
- Twin wheel carpet casters
- Soft casters (OTG10701) are available (page 171)

List Price **\$361**



OTG11641B - page 107
 High Back Mesh Back Synchro-Tilter
 Dimensions: 25w x 23d x 43h
 Ergonomic Features: A, B, C, H, L, M, N, S

- Black mesh back with breathable Black mesh fabric seat
- Pneumatic seat height adjustment
- Height adjustable arms with polyurethane armrests
- Synchro-tilt chair control with tilt tension adjustment
- Single position tilt lock
- Twin wheel carpet casters
- Soft casters (OTG10700) are available (page 171)

List Price **\$435**



OTG11328B - LIMITED QTY AVAILABLE - page 111
 Mesh Back Task
 Dimensions: 26.5w x 24d x 43h
 Ergonomic Features: A, B, C, E, L, M, N

- Black mesh back with patterned Black fabric seat
- Pneumatic seat height adjustment
- Fixed height arms with polyurethane armrests
- Synchro-tilt chair control with tilt tension adjustment
- Seat slider mechanism
- Twin wheel carpet casters
- Soft casters (OTG10700) are available (page 171)

List Price **\$440**



OTG11686B - page 103
 Mid Back Mesh Back Synchro-Tilter
 Dimensions: 25.5w x 24.5d x 36h
 Ergonomic Features: A, B, C, H, L, M, N

- Black mesh back with breathable Black mesh fabric seat
- Pneumatic seat height adjustment
- Height adjustable arms with polyurethane armrests
- Synchro-tilt chair control with infinite position tilt lock
- Twin wheel carpet casters
- Soft casters (OTG10701) are available (page 171)

List Price **\$462**



OTG12110B - page 104
 Mesh Back Luxhide Tilter
 Dimensions: 25w x 25d x 41h
 Ergonomic Features: A, B, C, H, M, N, S

- Black mesh back with Black Luxhide seat
- Pneumatic seat height adjustment
- Height adjustable arms with polyurethane armrests
- Single position tilt lock with tilt tension adjustment
- Unique lumbar pad with flexible support
- Twin wheel carpet casters
- Soft casters (OTG10701) are available (page 171)

List Price **\$467**



OTG11320B - page 114
 Low Back Mesh Back Tilter
 Dimensions: 23w x 24d x 39.5h
 Ergonomic Features: A, B, C, H, M, N, S

- Black mesh back with breathable Black mesh fabric seat
- Pneumatic seat height adjustment
- Height adjustable arms
- Single position tilt lock with tilt tension adjustment
- Twin wheel carpet casters
- Soft casters (OTG10700) are available (page 171)

List Price **\$371**



OTG12112B - page 109
 Mesh Back Tilter
 Dimensions: 25w x 24d x 41h
 Ergonomic Features: A, B, C, H, M, N, S

- Black mesh back with black Luxhide seat
- Pneumatic seat height adjustment
- Height adjustable arms with polyurethane armrests
- Single position tilt lock with tilt tension adjustment
- Twin wheel carpet casters
- Soft casters (OTG10701) are available (page 171)

List Price **\$387**



OTG11647B - page 107
 Mid Back Mesh Back Synchro-Tilter
 Dimensions: 24.5w x 22d x 37h
 Ergonomic Features: A, B, C, H, L, M, N, S

- Black mesh back with breathable Black mesh fabric seat
- Pneumatic seat height adjustment
- Height adjustable arms with polyurethane armrests
- Synchro-tilt chair control with tilt tension adjustment
- Single position tilt lock
- Twin wheel carpet casters
- Soft casters (OTG10700) are available (page 171)

List Price **\$393**



OTG11920B - pages 113, 148
 High Back Mesh Back Tilter
 Dimensions: 24w x 22.5d x 42h
 Ergonomic Features: A, B, C, H, M, N, S

- High back design
- Black mesh back with breathable Black air mesh fabric seat
- Pneumatic seat height adjustment
- Height adjustable arms with polyurethane armrests
- Tilter mechanism with single position tilt lock and tilt tension adjustment
- Twin wheel carpet casters
- Soft casters (OTG10701) are available (page 171)

List Price **\$414**



OTG10904B - page 110
 Mesh Back Synchro-Tilter
 Dimensions: 24w x 24d x 37.5h
 Ergonomic Features: A, B, C, H, L, M, N

- Black mesh back with breathable Black air mesh seat
- Pneumatic seat height adjustment
- Adjustable lumbar support
- Height adjustable arms with self-skinned urethane arm caps
- Synchro-tilt chair control with multiple-position tilt lock and tilt tension adjustment
- Twin wheel carpet casters
- Soft casters (OTG10701) are available (page 171)

List Price **\$477**



OTG11692 - page 101
 Mesh Tilter
 Dimensions: 24.5w x 25d x 38h
 Ergonomic Features: A, B, C, E, H, M, N, S

- Black mesh back with mock leather surround and perforated Luxhide seat
- Pneumatic seat height adjustment
- Height adjustable arms
- Single position tilt lock with tilt tension adjustment
- Seat depth adjustment
- Twin wheel carpet casters
- Soft casters (OTG10700) are available (page 171)

List Price **\$482**



OTG11516B - page 108
 High Back Mesh Back Synchro-Tilter
 Dimensions: 26.75w x 24d x 41.5h
 Ergonomic Features: A, B, C, H, L, M, N

- Black mesh back with breathable Black mesh fabric seat
- Pneumatic seat height adjustment
- Height adjustable arms with polyurethane armrests
- Synchro-tilt chair control with single position tilt lock
- Twin wheel carpet casters
- Soft casters (OTG10700) are available (page 171)

List Price **\$483**



OTG11865B - LIMITED QTY AVAILABLE - page 109
 Mesh Back Tilter
 Dimensions: 27w x 25d x 38h
 Ergonomic Features: A, B, C, H, M, N, S

- Black mesh back with patterned Black fabric seat
- Pneumatic seat height adjustment
- Height adjustable arms with titanium accents
- Single position tilt lock with tilt tension adjustment
- Twin wheel carpet casters
- Soft casters (OTG10701) are available (page 171)

List Price **\$488**



A Tilt Tension
 Increase or decrease to match body weight. Allows you to rock comfortably, reducing muscle fatigue.

B Chair Tilt Lock
 Lock the tilt movement in position(s) to accommodate your working posture. Allows you to lock your chair in a comfortable and supportive position. (can be either single position or infinite style).

C Seat Height
 Raise or lower to allow your feet to rest flat on the floor. Avoids pressure under your thighs, easing blood flow.

D Back Height
 Raise or lower to position lumbar support in your lumbar area. Reduces likelihood of back pain.

E Seat Depth
 Change the depth of the seat to accommodate the length of your thighs. Keeps your back in contact with the backrest while avoiding pressure behind your knees.

G Back Angle
 Adjust to change the angle of your torso in relation to your thighs. Helps reduce disc pressure and relaxes your back muscles.

H Arm Height
 Raise or lower to support your forearms. Reduces muscular effort in neck and shoulders, minimizing risk of pain.



L Synchro-Tilt Movement
 Backrest reclines at a faster rate than the seat, increasing the angle between your torso and thighs. Enhances comfort and encourages dynamic body movement.

M Waterfall Seat Edge
 Reduces pressure at the back of the knee, contributing to good blood flow.

N Properly Contoured Cushions
 Support the body effectively, allowing you to sit longer without discomfort.

Q Width Adjustable Arms
 Allows outward movement of armrests to match shoulder breadth. Ensures armrests properly support forearms, reducing muscular effort in neck and shoulders.

R Arm Rotation
 Rotate armcap to support your forearm in various positions. Reduces muscular effort in neck and shoulders, minimizing risk of pain.

S Center-Tilt Movement
 Chair tilts from a pivot point under the center of the seat allowing you to rock. When your feet are well supported, blood flow is enhanced.

V Lumbar Depth Adjustment
 Increase or decrease curvature of the back to match the profile of your lower back. Enhances comfort and support in the lower lumbar area.



OTG11685B - page 103
 High Back Mesh Back Synchro-Tilter
 Dimensions: 25.5w x 24.5d x 41h
 Ergonomic Features: A, B, C, H, L, M, N

- Black mesh back with breathable Black mesh fabric seat
- Pneumatic seat height adjustment
- Height adjustable arms with polyurethane armrests
- Synchro-tilt chair control with infinite position tilt lock
- Twin wheel carpet casters
- Soft casters (OTG10701) are available (page 171)

List Price **\$520**



OTG11980B - page 101
 Mesh Back Synchro-Tilter
 Dimensions: 26w x 24d x 44h
 Ergonomic Features: A, B, C, H, L, M, N

- Black mesh back with patterned Black fabric seat
- Pneumatic seat height adjustment
- Height adjustable arms with polyurethane armrests
- Synchro-tilt chair control with tilt tension adjustment
- Single position tilt lock
- Twin wheel carpet casters
- Soft casters (OTG10701) are available (page 171)

List Price **\$546**



OTG3191 - page 100
 Mesh Back Synchro-Tilter
 Dimensions: 24.5w x 23d x 43h
 Ergonomic Features: A, B, C, H, L, M, N

- High back design
- Black mesh back with Black Luxhide seat
- Pneumatic seat height adjustment
- Height and width adjustable arms with polyurethane armrests
- Synchro-tilt mechanism with single position tilt lock and tilt tension adjustment
- Single position tilt lock
- Ratchet back height adjustment
- Twin wheel carpet casters
- Soft casters (OTG10701) are available (page 171)

List Price **\$578**



OTG11769B - page 108
 Mesh Back Multi-Function
 Dimensions: 26.75w x 23.5d x 43h
 Ergonomic Features: A, B, C, D, E, G, H, M, N, Q, S

- Black mesh back with breathable Black mesh fabric seat
- Pneumatic seat height adjustment
- Height and width adjustable armrests
- Infinite seat tilt lock with tilt tension adjustment
- Back angle adjustment via internal ratchet
- Seat slider
- Twin wheel carpet casters
- Soft casters (OTG10700) are available (page 171)

List Price **\$583**



OTG11325B - page 100
 Mesh Back Synchro-Tilter
 Dimensions: 26w x 25d x 40h
 Ergonomic Features: A, B, C, H, L, M, N, R

- Black mesh back with patterned Black fabric seat
- Pneumatic seat height adjustment
- Height adjustable, rotatable, forward and rearward and side-to-side sliding armrests with polyurethane pads
- Black, vertically adjustable lumbar support
- Synchro-tilt chair control with tilt tension adjustment
- Single position tilt lock
- Polished Aluminum base
- Twin wheel carpet casters
- Soft casters (OTG10701) are available (page 171)

List Price **\$605**



OTG2801 - page 99
 Mesh Synchro-Tilter
 Dimensions: 26w x 26.5d x 39.5h
 Ergonomic Features: A, B, C, H, L, M, N

- Black mesh back with breathable Black mesh fabric seat
- Pneumatic seat height adjustment
- Height adjustable arms
- Multi-position seat tilt lock with anti-kick back feature
- Adjustable lumbar support
- Synchro-tilt chair control with tilt tension adjustment
- Twin wheel carpet casters
- Soft casters (OTG10701) are available (page 171)

List Price **\$632**



OTG2803 - page 99
 Mesh Multi-Function
 Dimensions: 26w x 26.5d x 39.5h
 Ergonomic Features: A, B, C, G, H, M, N, S

- Black mesh back with breathable Black mesh fabric seat
- Pneumatic seat height adjustment
- Height adjustable arms
- Adjustable lumbar support
- Infinite seat tilt lock with tilt tension adjustment
- Back angle adjustment
- Forward tilt control
- Twin wheel carpet casters
- Soft casters (OTG10701) are available (page 171)

List Price **\$659**



OTG3101 - LIMITED QTY AVAILABLE - page 97
 Mesh Back Synchro-Tilter
 Dimensions: 26w x 27d x 38.5h
 Ergonomic Features: A, B, C, E, H, L, M, N

- Black mesh back with Black Luxhide upholstered seat
- Pneumatic seat height adjustment
- Height adjustable arms
- Synchro-tilt mechanism
- Infinite seat tilt lock with tilt tension adjustment
- Height and depth adjustable lumbar support
- Twin wheel carpet casters
- Soft casters (OTG10701) are available (page 171)

List Price **\$707**



OTG3103 - LIMITED QTY AVAILABLE - page 97
 Mesh Back Multi-Function
 Dimensions: 26w x 27d x 39.5h
 Ergonomic Features: A, B, C, E, G, H, M, N, S

- Black mesh back with breathable Black mesh fabric seat
- Pneumatic seat height adjustment
- Height adjustable arms
- Multi-function mechanism with seat depth adjustment
- Back angle adjustment
- Forward tilt mechanism
- Infinite seat tilt lock with tilt tension adjustment
- Height and depth adjustable lumbar support
- Seat slider mechanism
- Twin wheel carpet casters
- Soft casters (OTG10701) are available (page 171)

List Price **\$744**



OTG2821 - page 99
 Mesh Seat and Back Synchro-Tilter
 Dimensions: 26w x 26.5d x 39.5h
 Ergonomic Features: A, B, C, H, L, M, N

- Black mesh back with Black mesh seat
- Pneumatic seat height adjustment
- Height adjustable arms
- Multiple-position tilt lock with anti-kick back feature
- Seat depth adjustment
- Adjustable lumbar support
- Synchro-tilt chair control with tilt tension adjustment
- Twin wheel carpet casters
- Soft casters (OTG10701) are available (page 171)

List Price **\$792**



OTG11685B
 Shown in Terrace Cherry Blossom (TC64).
 See pages 202-207 for additional color options.



- A Tilt Tension**
Increase or decrease to match body weight. Allows you to rock comfortably, without heavy pushing, reducing muscle fatigue.
- B Chair Tilt Lock**
Lock the tilt movement in position(s) to accommodate your working posture. Allows you to lock your chair in a comfortable and supportive position. (can be either single position or infinite style).
- C Seat Height**
Raise or lower to allow your feet to rest flat on the floor. Avoids pressure under your thighs, easing blood flow.
- D Back Height**
Raise or lower to position lumbar support in your lumbar area. Reduces likelihood of back pain.
- E Seat Depth**
Change the depth of the seat to accommodate the length of your thighs. Keeps your back in contact with the backrest while avoiding pressure behind your knees.
- G Back Angle**
Adjust to change the angle of your torso in relation to your thighs. Helps reduce disc pressure and relaxes your back muscles.
- H Arm Height**
Raise or lower to support your forearms. Reduces muscular effort in neck and shoulders, minimizing risk of pain.



- L Synchro-Tilt Movement**
Backrest reclines at a faster rate than the seat, increasing the angle between your torso and thighs. Enhances comfort and encourages dynamic body movement.
- M Waterfall Seat Edge**
Reduces pressure at the back of the knee, contributing to good blood flow.
- N Properly Contoured Cushions**
Support the body effectively, allowing you to sit longer without discomfort.
- Q Width Adjustable Arms**
Allows outward movement of armrests to match shoulder breadth. Ensures armrests properly support forearms, reducing muscular effort in neck and shoulders.
- R Arm Rotation**
Rotate armcap to support your forearm in various positions. Reduces muscular effort in neck and shoulders, minimizing risk of pain.
- S Center-Tilt Movement**
Chair tilts from a pivot point under the center of the seat allowing you to rock. When your feet are well supported, blood flow is enhanced.
- V Lumbar Depth Adjustment**
Increase or decrease curvature of the back to match the profile of your lower back. Enhances comfort and support in the lower lumbar area.



OTG11343B - page 117

Arm Mesh Task - Armless
 Dimensions: 19w x 23d x 37h
 Ergonomic Features: C, M, N

- Black air mesh fabric on back and seat with decorative accents
- Pneumatic seat height adjustment
- Armless design - height adjustable arms (OTG11620) are available
- Twin wheel carpet casters
- Drafting stool kit (OTG11600) available (pages 107, 116, 117, 136, 137)
- Soft casters (OTG10700) are available (page 171)

List Price ***223**



OTG11650 - page 117

Task - Armless
 Dimensions: 21w x 25d x 38h
 Ergonomic Features: C, E, M, N, S

- Patterned Black fabric upholstery
- Pneumatic seat height adjustment
- Seat depth adjustment
- Armless design - height adjustable arms (OTG11620) are available
- Twin wheel carpet casters
- Drafting stool kit (OTG11600) available (pages 107, 116, 117, 136, 137)
- Soft casters (OTG10700) are available (page 171)

List Price ***273**



OTG11612B - page 115

Tilter
 Dimensions: 26w x 26d x 36h
 Ergonomic Features: A, B, C, H, M, N, S

- Patterned Black fabric upholstery
- Pneumatic seat height adjustment
- Height adjustable armrests
- Single position tilt lock with tilt tension adjustment
- Fixed back angle
- Twin wheel carpet casters
- Soft casters (OTG10700) are available (page 171)

List Price ***345**



OTG11651 - page 105

Low Back Tilter
 Dimensions: 24w x 25.5d x 40h
 Ergonomic Features: A, B, C, H, N, S

- Patterned Black fabric upholstery
- Pneumatic seat height adjustment
- Height adjustable armrests
- Single position tilt lock with tilt tension adjustment
- Twin wheel carpet casters
- Soft casters (OTG10700) are available (page 171)

List Price ***354**



OTG11950B - page 110

Multi-Function
 Dimensions: 26.5w x 23.5d x 39h
 Ergonomic Features: A, B, C, D, E, G, H, M, N, S

- Patterned Black fabric upholstery
- Pneumatic seat height adjustment
- Height adjustable armrests
- Infinite seat tilt lock with tilt tension adjustment
- Back angle adjustment
- Back height adjustment via internal ratchet
- Seat slider
- Twin wheel carpet casters
- Soft casters (OTG10700) are available (page 171)

List Price ***467**



OTG11653 - page 104

Multi-Function
 Dimensions: 26.5w x 25d x 39h
 Ergonomic Features: A, B, C, D, G, H, M, N, R, S

- Patterned Black fabric upholstery
- Pneumatic seat height adjustment
- Height adjustable arms with pivot feature
- Infinite seat tilt lock with tilt tension adjustment
- Back angle adjustment
- Height adjustable lumbar support
- Twin wheel carpet casters
- Soft casters (OTG10700) are available (page 171)

List Price ***605**



OTG11850B - page 115

Tilter
 Dimensions: 25.5w x 23.5d x 38h
 Ergonomic Features: A, B, C, H, M, N, S

- Patterned Black fabric upholstery
- Pneumatic seat height adjustment
- Height adjustable arms with polyurethane armrests
- Single position tilt lock with tilt tension adjustment
- Fixed back angle
- Twin wheel carpet casters
- Soft casters (OTG10700) are available (page 171)

List Price ***366**



OTG11652 - page 105

High Back Tilter
 Dimensions: 26.5w x 25.5d x 42.5h
 Ergonomic Features: A, B, C, H, N, S

- Patterned Black fabric upholstery
- Pneumatic seat height adjustment
- Height adjustable armrests
- Single position tilt lock with tilt tension adjustment
- Twin wheel carpet casters
- Soft casters (OTG10700) are available (page 171)

List Price ***380**



OTG11715B - LIMITED QTY AVAILABLE - page 114

Synchro-Tilter
 Dimensions: 25.5w x 21.5d x 40.5h
 Ergonomic Features: A, B, C, H, L, M, N

- Patterned Black fabric upholstery
- Pneumatic seat height adjustment
- Height adjustable arms
- Synchro-tilt chair control with tilt tension adjustment
- Single position tilt lock
- Twin wheel carpet casters
- Soft casters (OTG10701) are available (page 171)

List Price ***414**



OTG11631B - page 111

Multi-Function
 Dimensions: 25.5w x 25d x 44h
 Ergonomic Features: A, B, C, D, G, H, M, N, S

- Patterned Black fabric upholstery
- Pneumatic seat height adjustment
- Height adjustable armrests
- Height adjustable lumbar support
- Twin wheel carpet casters
- Soft casters (OTG10700) are available (page 171)

List Price ***446**



OTG11710 - page 96

Multi-Function
 Dimensions: 26w x 24.5d x 42h
 Ergonomic Features: A, B, C, D, G, H, M, N, S

- Patterned Black fabric upholstery
- Pneumatic seat height adjustment
- Height and width adjustable armrests
- Infinite seat tilt lock with tilt tension adjustment
- Back angle adjustment
- Back height adjustment via internal ratchet
- Forward tilt control
- Twin wheel carpet casters
- Soft casters (OTG10700) are available (page 171)

List Price ***707**



OTG2913 - page 96

Multi-Function
 Dimensions: 25w x 24d x 41h
 Ergonomic Features: A, B, C, D, E, G, H, M, N, Q, S

- Black Luxhide upholstery with mock leather trim
- Pneumatic seat height adjustment
- Height and width adjustable armrests
- Infinite seat tilt lock with tilt tension adjustment
- Back angle adjustment
- Back height adjustment via internal ratchet
- Forward tilt control
- Seat depth adjustment via seat slider
- Twin wheel carpet casters
- Soft casters (OTG10701) are available (page 171)

List Price ***792**



OTG2913
 Shown in Luxhide White (BL28).
 See pages 202-207 for additional color options.



A Tilt Tension
 Increase or decrease to match body weight. Allows you to rock comfortably, reducing muscle fatigue.



B Chair Tilt Lock
 Lock the tilt movement in position(s) to accommodate your working posture. Allows you to lock your chair in a comfortable and supportive position. (can be either single position or infinite style).



C Seat Height
 Raise or lower to allow your feet to rest flat on the floor. Avoids pressure under your thighs, easing blood flow.



D Back Height
 Raise or lower to position lumbar support in your lumbar area. Reduces likelihood of back pain.



E Seat Depth
 Change the depth of the seat to accommodate the length of your thighs. Keeps your back in contact with the backrest while avoiding pressure behind your knees.



G Back Angle
 Adjust to change the angle of your torso in relation to your thighs. Helps reduce disc pressure and relaxes your back muscles.



H Arm Height
 Raise or lower to support your forearms. Reduces muscular effort in neck and shoulders, minimizing risk of pain.



L Synchro-Tilt Movement
 Backrest reclines at a faster rate than the seat, increasing the angle between your torso and thighs. Enhances comfort and encourages dynamic body movement.



M Waterfall Seat Edge
 Reduces pressure at the back of the knee, contributing to good blood flow.



N Properly Contoured Cushions
 Support the body effectively, allowing you to sit longer without discomfort.



Q Width Adjustable Arms
 Allows outward movement of armrests to match shoulder breadth. Ensures armrests properly support forearms, reducing muscular effort in neck and shoulders.



R Arm Rotation
 Rotate armcap to support your forearm in various positions. Reduces muscular effort in neck and shoulders, minimizing risk of pain.



S Center-Tilt Movement
 Chair tilts from a pivot point under the center of the seat allowing you to rock. When your feet are well supported, blood flow is enhanced.



V Lumbar Depth Adjustment
 Increase or decrease curvature of the back to match the profile of your lower back. Enhances comfort and support in the lower lumbar area.



OTG10900B - page 133
 Mesh Back Tilter
 Dimensions: 22.5w x 22.5d x 37h
 Ergonomic Features: A, B, C, M, N, S

- Grey mesh back with breathable Black mesh fabric seat
- Pneumatic seat height adjustment
- Molded arms
- Single position tilt lock with tilt tension adjustment
- Twin wheel carpet casters
- Soft casters (OTG10701) are available (page 171)

List Price ***239**



OTG10901B - LIMITED QTY AVAILABLE - page 132
 Mesh Back Tilter
 Dimensions: 23.5w x 22d x 34h
 Ergonomic Features: A, B, C, M, N, S

- Black mesh back with breathable Black mesh fabric seat
- Pneumatic seat height adjustment
- Molded arms
- Single position tilt lock with tilt tension adjustment
- Chrome accent on outer back
- Twin wheel carpet casters
- Soft casters (OTG10701) are available (page 171)

List Price ***265**



OTG10902B - page 133
 Mesh Back Tilter
 Dimensions: 23w x 24d x 39h
 Ergonomic Features: A, B, C, M, N, S

- Grey mesh back with breathable Black mesh fabric seat
- Pneumatic seat height adjustment
- Molded arms
- Single position tilt lock with tilt tension adjustment
- Twin wheel carpet casters
- Soft casters (OTG10701) are available (page 171)

List Price ***265**



OTG13026B - page 135
 Mesh Low Back Tilter
 Dimensions: 23w x 23.5d x 40h
 Ergonomic Features: A, B, C, M, N, S

- Black mesh back with Black Luxhide seat
- Pneumatic seat height adjustment
- Fixed "twisted ribbon" molded arms
- Single position tilt lock with tilt tension adjustment
- Twin wheel carpet casters
- Soft casters (OTG10701) are available (page 171)

List Price ***350**



OTG11776B - page 131
 Luxhide Tilter
 Dimensions: 24.5w x 25d x 41.5h
 Ergonomic Features: A, B, C, M, N, S

- Black Luxhide upholstery with mock leather trim
- Pneumatic seat height adjustment
- Fixed height molded arms
- Single position tilt lock with tilt tension adjustment
- Twin wheel carpet casters
- Soft casters (OTG10700) are available (page 171)

List Price ***281**



OTG11782B - page 131
 Luxhide Tilter
 Dimensions: 25w x 26d x 46h
 Ergonomic Features: A, B, C, M, N, S

- Black Luxhide upholstery with mock leather trim
- Pneumatic seat height adjustment
- Fixed height molded arms with upholstered inset cap
- Single position tilt lock with tilt tension adjustment
- Twin wheel carpet casters
- Soft casters (OTG10700) are available (page 171)

List Price ***356**



OTG11617B - page 130
 Luxhide Tilter
 Dimensions: 26w x 27d x 42.5h
 Ergonomic Features: A, B, C, N, S

- Black Luxhide upholstery with mock leather trim
- Pneumatic seat height adjustment
- Fixed height molded arms with padded armrests
- Single position tilt lock with tilt tension adjustment
- Twin wheel carpet casters
- Soft casters (OTG10700) are available (page 171)

List Price ***393**



OTG11975B - page 130
 Luxhide Tilter
 Dimensions: 28w x 23d x 41.5h
 Ergonomic Features: A, B, C, M, N, S

- Black Luxhide upholstery with mock leather trim
- Pneumatic seat height adjustment
- Fixed height molded arms with upholstered armrests
- Single position tilt lock with tilt tension adjustment
- Twin wheel carpet casters
- Soft casters (OTG10700) are available (page 171)

List Price ***403**



OTG11750B - page 132
 Mesh Back Tilter
 Dimensions: 27w x 24d x 40.5h
 Ergonomic Features: A, B, C, M, N, S

- Black mesh back with breathable Black mesh fabric seat
- Pneumatic seat height adjustment
- Fixed height upholstered armrests
- Single position tilt lock with tilt tension adjustment
- Twin wheel carpet casters
- Soft casters (OTG10700) are available (page 171)

List Price ***356**



OTG11657B - page 127
 Mesh Back Tilter
 Dimensions: 24w x 23.5d x 41h
 Ergonomic Features: A, B, C, M, N, S

- Black mesh back with breathable Black mesh fabric seat
- Pneumatic seat height adjustment
- Aluminum arms with padded armrests (arms can be removed to achieve a fully polished look)
- Single position tilt lock with tilt tension adjustment
- Twin wheel carpet casters
- Soft casters (OTG10700) are available (page 171)

List Price ***446**



OTG11790B - LIMITED QTY AVAILABLE - page 126
 Mesh Back Knee-Tilter
 Dimensions: 23w x 25d x 38.5h
 Ergonomic Features: A, B, C, M, N, S

- Black mesh back with breathable Black mesh fabric seat
- Pneumatic seat height adjustment
- Polished Aluminum arms with polyurethane armrests
- Knee-tilt mechanism with multiple position tilt lock
- Twin wheel carpet casters
- Soft casters (OTG10700) are available (page 171)

List Price ***536**



OTG2788 - page 126
 Luxhide Tilter
 Dimensions: 25.5w x 27.5d x 42h
 Ergonomic Features: A, B, C, M, N, S

- Black Luxhide upholstery with mock leather trim
- Pneumatic seat height adjustment
- Black molded arms
- Single position tilt lock with tilt tension adjustment
- Twin wheel carpet casters
- Soft casters (OTG10700) are available (page 171)

List Price ***498**



OTG11858B - page 120
 Luxhide Segmented Cushion Tilter
 Dimensions: 25.5w x 26d x 44.5h
 Ergonomic Features: A, B, C, M, N, S

- Black Luxhide upholstery with mock leather trim
- Pneumatic seat height adjustment
- Chrome arms with upholstered armrests
- Single position tilt lock
- Swivel/tilt mechanism with tilt tension adjustment
- Twin wheel carpet casters
- Soft casters (OTG10700) are available (page 171)

List Price ***509**



OTG11735 - page 125
 Mid Back Luxhide Tilter - Armless
 Dimensions: 23.5w x 24.5d x 38h
 Ergonomic Features: A, B, C, M, N, S

- Black Luxhide upholstery with mock leather trim
- Pneumatic seat height adjustment
- Single position tilt lock with tilt tension adjustment
- Twin wheel carpet casters
- Soft casters (OTG10700) are available (page 171)

List Price ***519**



OTG11618B - page 121
 Luxhide Tilter
 Dimensions: 25.5w x 30d x 44.5h
 Ergonomic Features: A, B, C, M, N, S

- Black Luxhide upholstery with mock leather trim
- Pneumatic seat height adjustment
- Fixed height molded arms with padded armrests
- Single position tilt lock with tilt tension adjustment
- Integrated headrest
- Twin wheel carpet casters
- Soft casters (OTG10700) are available (page 171)

List Price ***515**

A Tilt Tension
 Increase or decrease to match body weight. Allows you to rock comfortably, reducing muscle fatigue.

B Chair Tilt Lock
 Lock the tilt movement in position(s) to accommodate your working posture. Allows you to lock your chair in a comfortable and supportive position. (can be either single position or infinite style).

C Seat Height
 Raise or lower to allow your feet to rest flat on the floor. Avoids pressure under your thighs, easing blood flow.

D Back Height
 Raise or lower to position lumbar support in your lumbar area. Reduces likelihood of back pain.

E Seat Depth
 Change the depth of the seat to accommodate the length of your thighs. Keeps your back in contact with the backrest while avoiding pressure behind your knees.

G Back Angle
 Adjust to change the angle of your torso in relation to your thighs. Helps reduce disc pressure and relaxes your back muscles.

H Arm Height
 Raise or lower to support your forearms. Reduces muscular effort in neck and shoulders, minimizing risk of pain.

L Synchro-Tilt Movement
 Backrest reclines at a faster rate than the seat, increasing the angle between your torso and thighs. Enhances comfort and encourages dynamic body movement.

M Waterfall Seat Edge
 Reduces pressure at the back of the knee, contributing to good blood flow.

N Properly Contoured Cushions
 Support the body effectively, allowing you to sit longer without discomfort.

Q Width Adjustable Arms
 Allows outward movement of armrests to match shoulder breadth. Ensures armrests properly support forearms, reducing muscular effort in neck and shoulders.

R Arm Rotation
 Rotate armcap to support your forearm in various positions. Reduces muscular effort in neck and shoulders, minimizing risk of pain.

S Center-Tilt Movement
 Chair tilts from a pivot point under the center of the seat allowing you to rock. When your feet are well supported, blood flow is enhanced.

V Lumbar Depth Adjustment
 Increase or decrease curvature of the back to match the profile of your lower back. Enhances comfort and support in the lower lumbar area.



OTG11734B - page 125
 Mid Back Luxhide Tilter
 Dimensions: 23.5w x 24.5d x 38h
 Ergonomic Features: A, B, C, M, N, S

- Black Luxhide upholstery with mock leather trim
- Pneumatic seat height adjustment
- Polished Aluminum arms (arms can be removed to achieve a sleek look)
- Single position tilt lock with tilt tension adjustment
- Twin wheel carpet casters
- Soft casters (OTG10700) are available (page 171)

List Price ***519**



OTG2701 - page 123
 Mid Back Luxhide Tilter
 Dimensions: 27w x 28d x 39h
 Ergonomic Features: A, B, C, M, N, S

- Black Luxhide upholstery with mock leather trim
- Pneumatic seat height adjustment
- Polyurethane "reverse curve" arms
- Single position tilt lock with tilt tension adjustment
- Twin wheel carpet casters
- Soft casters (OTG10700) are available (page 171)

List Price ***541**



OTG11786B - LIMITED QTY AVAILABLE - page 129
 Specialty Luxhide Tilter
 Dimensions: 24.5w x 25d x 41.5h
 Ergonomic Features: A, B, C, M, N, S

- Black Luxhide upholstery with mock leather trim
- Pneumatic seat height adjustment
- Chrome plated steel base
- Tilt tension adjustment
- Twin wheel carpet casters
- Soft casters (OTG10700) are available (page 171)

List Price ***546**



OTG11732 - page 125
 High Back Luxhide Tilter - Armless
 Dimensions: 23.5w x 24.5d x 40h
 Ergonomic Features: A, B, C, M, N, S

- Black or White Luxhide upholstery with mock leather trim
- Pneumatic seat height adjustment
- Single position tilt lock with tilt tension adjustment
- Twin wheel carpet casters
- Soft casters (OTG10700) are available (page 171)

List Price ***557**



OTG11730B - page 125
 High Back Luxhide Tilter
 Dimensions: 23.5w x 24.5d x 40h
 Ergonomic Features: A, B, C, M, N, S

- Black or White Luxhide upholstery with mock leather trim
- Pneumatic seat height adjustment
- Polished Aluminum arms (arms can be removed to achieve a sleek look)
- Single position tilt lock with tilt tension adjustment
- Twin wheel carpet casters
- Soft casters (OTG10700) are available (page 171)

List Price ***557**



OTG2700 - page 123
 High Back Luxhide Tilter
 Dimensions: 27w x 28d x 42h
 Ergonomic Features: A, B, C, M, N, S

- Black Luxhide upholstery with mock leather trim
- Pneumatic seat height adjustment
- Polyurethane "reverse curve" arms
- Single position tilt lock with tilt tension adjustment
- Twin wheel carpet casters
- Soft casters (OTG10700) are available (page 171)

List Price ***562**



OTG11300B - page 121
 Luxhide Tilter with Wood Arms and Base
 Dimensions: 28.5w x 28d x 45h
 Ergonomic Features: A, B, C, N, S

- Black Luxhide upholstery with mock leather trim
- Pneumatic seat height adjustment
- Padded armrests
- Single position tilt lock with tilt tension adjustment
- Integral headrest
- Wood arms and wood capped base in Cordovan (CX) finish
- Twin wheel carpet casters
- Soft casters (OTG10701) are available (page 171)

List Price ***583**



OTG11648B - page 120
 Luxhide Segmented Tilter
 Dimensions: 24.5w x 24.5d x 41h
 Ergonomic Features: A, B, C, M, N, S

- Black Luxhide upholstery with mock leather trim
- Pneumatic seat height adjustment
- Chrome arms with upholstered armrests (arms can be removed to achieve a sleek look)
- Single position tilt lock
- Swivel/tilt mechanism with tilt tension adjustment
- Twin wheel carpet casters
- Soft casters (OTG10700) are available (page 171)

List Price ***610**



OTG11786B
 Shown in Luxhide Saddle (BL23).
 See pages 202-207 for additional color options.



A Tilt Tension
 Increase or decrease to match body weight. Allows you to rock comfortably, without heavy pushing, reducing muscle fatigue.



B Chair Tilt Lock
 Lock the tilt movement in position(s) to accommodate your working posture. Allows you to lock your chair in a comfortable and supportive position. (can be either single position or infinite style).



C Seat Height
 Raise or lower to allow your feet to rest flat on the floor. Avoids pressure under your thighs, easing blood flow.



D Back Height
 Raise or lower to position lumbar support in your lumbar area. Reduces likelihood of back pain.



E Seat Depth
 Change the depth of the seat to accommodate the length of your thighs. Keeps your back in contact with the backrest while avoiding pressure behind your knees.



G Back Angle
 Adjust to change the angle of your torso in relation to your thighs. Helps reduce disc pressure and relaxes your back muscles.



H Arm Height
 Raise or lower to support your forearms. Reduces muscular effort in neck and shoulders, minimizing risk of pain.



L Synchro-Tilt Movement
 Backrest reclines at a faster rate than the seat, increasing the angle between your torso and thighs. Enhances comfort and encourages dynamic body movement.



M Waterfall Seat Edge
 Reduces pressure at the back of the knee, contributing to good blood flow.



N Properly Contoured Cushions
 Support the body effectively, allowing you to sit longer without discomfort.



Q Width Adjustable Arms
 Allows outward movement of armrests to match shoulder breadth. Ensures armrests properly support forearms, reducing muscular effort in neck and shoulders.



R Arm Rotation
 Rotate armcap to support your forearm in various positions. Reduces muscular effort in neck and shoulders, minimizing risk of pain.



S Center-Tilt Movement
 Chair tilts from a pivot point under the center of the seat allowing you to rock. When your feet are well supported, blood flow is enhanced.



V Lumbar Depth Adjustment
 Increase or decrease curvature of the back to match the profile of your lower back. Enhances comfort and support in the lower lumbar area.



OTG11761B - page 151
 Armless Mesh Back Guest Chair with Casters
 Dimensions: 20.5w x 22.5d x 35h
 Ergonomic Features: M, N

- Black mesh back with breathable Black mesh fabric seat
- Four leg design with casters
- Does not stack
- Soft casters (OTG10701) are available (page 171)

List Price ***260**



OTG11760B - page 151
 Mesh Back Guest Chair
 Dimensions: 23.5w x 23.25d x 34h
 Ergonomic Features: M, N

- Black mesh back with breathable Black mesh fabric seat
- Four leg design with molded armrests
- Does not stack

List Price ***276**



OTG11923B - LIMITED QTY AVAILABLE - pages 113, 148
 Armless Mesh Back Guest Chair
 Dimensions: 20.75w x 22d x 38h
 Ergonomic Features: M, N

- Black mesh back with breathable Black air mesh fabric seat
- Powder coated cantilever base
- Chair frame glides
- Does not stack

List Price ***303**



OTG11740B - page 147
 Plastic Back Guest Chair
 Dimensions: 24.5w x 22.5d x 34h
 Ergonomic Features: M, N

- Perforated plastic back with Black mesh fabric seat
- Oval tube chrome frame with molded armrests
- Can be stacked up to 5 high
- Packed 2 chairs per carton (priced each)

List Price ***318**



OTG11892 - page 150
 Guest
 Dimensions: 23w x 26.5d x 34h
 Ergonomic Features: M, N

- Patterned Black fabric upholstery
- Mid-back design
- Sled base design with Black powder coated steel frame
- Upholstered armrests

List Price ***364**



OTG11770BCX - page 149
 Luxhide Guest Chair with Wood Accents
 Dimensions: 24w x 26d x 34.5h
 Ergonomic Features: M, N

- Black Luxhide with mock leather trim
- Cordovan (CX) finished wood arms and legs

List Price ***366**



OTG11770BES - page 149
 Luxhide Guest Chair with Wood Accents
 Dimensions: 24w x 26d x 34.5h
 Ergonomic Features: M, N

- Black Luxhide with mock leather trim
- Espresso (ES) finished wood arms and legs

List Price ***366**



OTG2782 - pages 123, 145
 Luxhide Guest
 Dimensions: 24.5w x 25.5d x 36.5h
 Ergonomic Features: M, N

- Black Luxhide upholstery with mock leather trim
- Attractive sled base design
- Upholstered armrests

List Price ***428**



OTG3918B - page 147
 Guest
 Dimensions: 24.5w x 24d x 34h
 Ergonomic Features: M, N

- Black fabric upholstered seat and back
- Comfortable polyurethane arms
- Black powder coated steel frame
- 4 leg design

List Price ***318**



OTG3915B - page 149
 Luxhide Guest
 Dimensions: 24.5w x 27d x 33.5h
 Ergonomic Features: M, N

- Black Luxhide upholstery with mock leather trim
- Black epoxy powder coated steel frame with upholstered armrests

List Price ***324**



OTG13050B - pages 135, 146
 Low Back Mesh Armchair with Luxhide Seat
 Dimensions: 23w x 23.5d x 36.5h
 Ergonomic Features: M, N

- Black mesh back with Black Luxhide seat
- Fixed "twisted ribbon" molded arms
- Black painted steel frame
- Can be fitted with either glides or carpet casters (both are included)

List Price ***350**



OTG11512B - page 144
 Mesh Back Guest Chair
 Dimensions: 22w x 24d x 33.5h
 Ergonomic Features: M, N

- Black mesh back with Black air mesh seat
- Polyurethane arm caps
- Black powder coated steel frame

List Price ***356**



OTG11820B(CX) - page 145
 Wood Guest
 Dimensions: 23w x 23d x 32.5h
 Ergonomic Features: M, N

- Black Luxhide seat upholstery
- Sophisticated wood frame design
- Cordovan (CX) finish

List Price ***456**



OTG11820B(TH) - page 145
 Wood Guest
 Dimensions: 23w x 23d x 32.5h
 Ergonomic Features: M, N

- Black Luxhide seat upholstery
- Sophisticated wood frame design
- Toffee (TH) finish

List Price ***456**



OTG2809 - page 144
 Mesh Back Guest
 Dimensions: 22.25w x 24d x 34.5h
 Ergonomic Features: M, N

- Black mesh back with Black mesh fabric seat
- Molded armrests
- Four leg design

List Price ***487**

OTG13050BT - pages 135, 146
 Tablet
 List Price ***106**



A Tilt Tension
 Increase or decrease to match body weight. Allows you to rock comfortably, reducing muscle fatigue.



B Chair Tilt Lock
 Lock the tilt movement in position(s) to accommodate your working posture. Allows you to lock your chair in a comfortable and supportive position. (can be either single position or infinite style).



C Seat Height
 Raise or lower to allow your feet to rest flat on the floor. Avoids pressure under your thighs, easing blood flow.



D Back Height
 Raise or lower to position lumbar support in your lumbar area. Reduces likelihood of back pain.



E Seat Depth
 Change the depth of the seat to accommodate the length of your thighs. Keeps your back in contact with the backrest while avoiding pressure behind your knees.



G Back Angle
 Adjust to change the angle of your torso in relation to your thighs. Helps reduce disc pressure and relaxes your back muscles.



H Arm Height
 Raise or lower to support your forearms. Reduces muscular effort in neck and shoulders, minimizing risk of pain.



L Synchro-Tilt Movement
 Backrest reclines at a faster rate than the seat, increasing the angle between your torso and thighs. Enhances comfort and encourages dynamic body movement.



M Waterfall Seat Edge
 Reduces pressure at the back of the knee, contributing to good blood flow.



N Properly Contoured Cushions
 Support the body effectively, allowing you to sit longer without discomfort.



Q Width Adjustable Arms
 Allows outward movement of armrests to match shoulder breadth. Ensures armrests properly support forearms, reducing muscular effort in neck and shoulders.



R Arm Rotation
 Rotate armcap to support your forearm in various positions. Reduces muscular effort in neck and shoulders, minimizing risk of pain.



S Center-Tilt Movement
 Chair tilts from a pivot point under the center of the seat allowing you to rock. When your feet are well supported, blood flow is enhanced.



V Lumbar Depth Adjustment
 Increase or decrease curvature of the back to match the profile of your lower back. Enhances comfort and support in the lower lumbar area.



OTG11934 - page 153
 Armless Stack
 Dimensions: 17.5w x 22.5d x 33.5h
 Ergonomic Features: M, N

- Patterned Black fabric upholstery
- Black powder coated steel frame
- Floor and stack bumpers
- Can be stacked 10 high on optional dolly (OTG11705)
- Packed 2 per carton (priced each)

List Price **\$150**
OTG11705 - LIMITED QTY AVAILABLE Dolly - page 153
 List Price **\$156**



OTG11310B - page 154
 Medium Density Stacking
 Dimensions: 18.25w x 20.5d x 32h

- Impact resistant Black plastic seat and back (one piece)
- Chrome plated steel rod frame
- Can be stacked 8 high on the floor or 24 high on dolly (OTG11311B)
- Packed 4 per carton (priced each)

List Price **\$170**
OTG11311B - LIMITED QTY AVAILABLE Dolly - page 154
 List Price **\$308**
OTG11312 - LIMITED QTY AVAILABLE Connectors - page 154
 List Price **\$27**
OTG11313 Glides - page 154
 List Price **\$22** (per pair)



OTG11697 - page 152
 Armless Stack
 Dimensions: 18.5w x 23.5d x 30h
 Ergonomic Features: M, N

- Patterned Black fabric upholstery
- Tubular chrome frame
- Can be stacked 13 high on the floor or 15 high on optional dolly (OTG11698)
- Packed 2 per carton (priced each)

List Price **\$182**
OTG11698 - LIMITED QTY AVAILABLE Dolly - page 152
 List Price **\$321**



OTG1221B - page 155
 Armless Stack
 Dimensions: 18w x 21d x 31.5h

- Impact resistant Black plastic seat and back
- Chrome steel frame
- Can be stacked 5 high on the floor
- Packed 4 per carton (priced each)

List Price **\$186**



OTG11703 - page 152
 Stack
 Dimensions: 21.5w x 23d x 30.5h
 Ergonomic Features: M, N

- Patterned Black fabric upholstery
- Black powder coated frame
- Can be stacked 4 high on optional dolly (OTG11706)
- Packed 2 per carton (priced each)

List Price **\$241**
OTG11706 - LIMITED QTY AVAILABLE Dolly - page 152
 List Price **\$268**



OTG11700 - page 155
 Armless Plastic Back Stack
 Dimensions: 22w x 22.5d x 31h

- Impact resistant Black plastic seat and back
- Chrome steel frame
- Can be stacked 12 high with or without optional dolly (OTG11701)
- Packed 2 per carton (priced each)

List Price **\$193**
OTG11701 - LIMITED QTY AVAILABLE Dolly - page 155
 List Price **\$209**



OTG2748 - page 153
 Armless Stack
 Dimensions: 19.5w x 22.5d x 32h
 Ergonomic Features: M, N

- Patterned Black fabric upholstery
- Black powder coated frame
- Can be stacked 4 high with or without optional dolly (GC3010)
- Packed 2 per carton (priced each)

List Price **\$193**
GC3010 - LIMITED QTY AVAILABLE Dolly - page 153
 List Price **\$240**



OTG1220B - page 155
 Stack
 Dimensions: 21.5w x 21d x 31.5h

- Impact resistant Black plastic seat and back
- Chrome steel frame
- Can be stacked 5 high on the floor
- Packed 4 per carton (priced each)

List Price **\$202**



OTG11704 - page 152
 Armless Stack
 Dimensions: 21.5w x 23d x 30.5h
 Ergonomic Features: M, N

- Patterned Black fabric upholstery
- Black powder coated frame
- Can be stacked 4 high on optional dolly (OTG11706)
- Packed 2 per carton (priced each)

List Price **\$214**
OTG11706 - LIMITED QTY AVAILABLE Dolly - page 152
 List Price **\$268**



OTG11341B - page 150
 Armless Mesh Back Flip Seat Nesting
 Dimensions: 22w x 22d x 33h
 Ergonomic Features: M, N

- Black mesh back with breathable Black air mesh fabric seat
- Flip seat design allows chair to be nested horizontally
- Black painted steel frame
- Swivelling carpet casters
- Does not stack
- Packed 2 per carton (priced each)
- Soft casters (OTG10701) are available (page 171)

List Price **\$377**



OTG11340B - page 150
 Mesh Back Flip Seat Nesting
 Dimensions: 25.5w x 22d x 33h
 Ergonomic Features: M, N

- Black mesh back with breathable Black air mesh fabric seat
- Black polypropylene arms
- Flip seat design allows chair to be nested horizontally
- Black painted steel frame
- Swivelling carpet casters
- Does not stack
- Packed 2 per carton (priced each)
- Soft casters (OTG10701) are available (page 171)

List Price **\$424**

A Tilt Tension
 Increase or decrease to match body weight. Allows you to rock comfortably, reducing muscle fatigue.

B Chair Tilt Lock
 Lock the tilt movement in position(s) to accommodate your working posture. Allows you to lock your chair in a comfortable and supportive position. (can be either single position or infinite style).

C Seat Height
 Raise or lower to allow your feet to rest flat on the floor. Avoids pressure under your thighs, easing blood flow.

D Back Height
 Raise or lower to position lumbar support in your lumbar area. Reduces likelihood of back pain.

E Seat Depth
 Change the depth of the seat to accommodate the length of your thighs. Keeps your back in contact with the backrest while avoiding pressure behind your knees.

G Back Angle
 Adjust to change the angle of your torso in relation to your thighs. Helps reduce disc pressure and relaxes your back muscles.

H Arm Height
 Raise or lower to support your forearms. Reduces muscular effort in neck and shoulders, minimizing risk of pain.

L Synchro-Tilt Movement
 Backrest reclines at a faster rate than the seat, increasing the angle between your torso and thighs. Enhances comfort and encourages dynamic body movement.

M Waterfall Seat Edge
 Reduces pressure at the back of the knee, contributing to good blood flow.

N Properly Contoured Cushions
 Support the body effectively, allowing you to sit longer without discomfort.

Q Width Adjustable Arms
 Allows outward movement of armrests to match shoulder breadth. Ensures armrests properly support forearms, reducing muscular effort in neck and shoulders.

R Arm Rotation
 Rotate armcap to support your forearm in various positions. Reduces muscular effort in neck and shoulders, minimizing risk of pain.

S Center-Tilt Movement
 Chair tilts from a pivot point under the center of the seat allowing you to rock. When your feet are well supported, blood flow is enhanced.

V Lumbar Depth Adjustment
 Increase or decrease curvature of the back to match the profile of your lower back. Enhances comfort and support in the lower lumbar area.



OTG5002 - LIMITED QTY AVAILABLE - page 139
Single Arm - Reversible
Dimensions: 3w x 18.5d x 9h
List Price ***177**



OTG5002C - LIMITED QTY AVAILABLE - page 139
Single Arm - Center
Used to define seating areas
Dimensions: 3w x 18.5d x 9h
List Price ***177**



OTG5003 - LIMITED QTY AVAILABLE - page 139
Cushion Bridge
Can be used for seating applications and will support a person's weight
Dimensions: 25w x 22d x 4h
List Price ***241**



OTG5004 - LIMITED QTY AVAILABLE - page 139
Single Bench
Dimensions: 25w x 23d x 17.5h
List Price ***402**



OTG5001NA - LIMITED QTY AVAILABLE - page 139
Armless Single Seat
Dimensions: 25w x 29d x 30.5h
List Price ***621**



OTG5011 - LIMITED QTY AVAILABLE - page 139
Pair of Connecting Brackets
List Price ***49/pair**



OTG13012 - page 141
Square Shaped Modular Ottoman
Snap-in bell-shaped glides
Dimensions: 20w x 20d x 17.5h
List Price ***386**



OTG13011 - page 141
Rectangular Shaped Modular Ottoman
Snap-in bell-shaped glides
Dimensions: 40.5w x 20d x 17.5h
List Price ***498**



OTG13010 - page 141
V-Shaped Modular Ottoman
Snap-in bell-shaped glides
Dimensions: 43w x 27.5d x 17.5h
List Price ***610**



OTG13007 - page 141
Round Shaped Modular Ottoman
Snap-in bell-shaped glides
Dimensions: 20w x 20d x 17.5h
List Price ***354**



OTG13008 - page 141
Half Round Shaped Modular Ottoman
Snap-in bell-shaped glides
Dimensions: 40w x 21d x 17.5h
List Price ***455**



OTG13009 - page 141
Wedge Shaped Modular Ottoman
Snap-in bell-shaped glides
Dimensions: 40w x 17.75d x 17.5h
List Price ***471**



A Tilt Tension
Increase or decrease to match body weight. Allows you to rock comfortably, reducing muscle fatigue.



B Chair Tilt Lock
Lock the tilt movement in position(s) to accommodate your working posture. Allows you to lock your chair in a comfortable and supportive position. (can be either single position or infinite style).



C Seat Height
Raise or lower to allow your feet to rest flat on the floor. Avoids pressure under your thighs, easing blood flow.



D Back Height
Raise or lower to position lumbar support in your lumbar area. Reduces likelihood of back pain.



E Seat Depth
Change the depth of the seat to accommodate the length of your thighs. Keeps your back in contact with the backrest while avoiding pressure behind your knees.



G Back Angle
Adjust to change the angle of your torso in relation to your thighs. Helps reduce disc pressure and relaxes your back muscles.



H Arm Height
Raise or lower to support your forearms. Reduces muscular effort in neck and shoulders, minimizing risk of pain.



OTG11924 - LIMITED QTY AVAILABLE - pages 113, 116, 136, 148
Adjustable Height Arm Kit
Dimensions: 25w x 23d x 43h
List Price ***85**



OTG11620 - pages 107, 116, 117, 136, 137
Adjustable Height Arm Kit
Dimensions: 25w x 23d x 43h
List Price ***96**



OTG10700
Set of Five Soft Casters
List Price ***53**



OTG10701
Set of Five Soft Casters
List Price ***54**



OTG11600 - pages 107, 116, 117, 136, 137
Drafting Stool Kit with 10" Gas Cylinder
• 26" flat injection molded base
• Twin wheel carpet casters
• 10" gas cylinder
• Height adjustable aluminum foot ring with locking knob
• Casters included
• Available on OTG11922B, OTG11642B, OTG11650 and OTG11343B only
List Price ***223**



L Synchro-Tilt Movement
Backrest reclines at a faster rate than the seat, increasing the angle between your torso and thighs. Enhances comfort and encourages dynamic body movement.



M Waterfall Seat Edge
Reduces pressure at the back of the knee, contributing to good blood flow.



N Properly Contoured Cushions
Support the body effectively, allowing you to sit longer without discomfort.



Q Width Adjustable Arms
Allows outward movement of armrests to match shoulder breadth. Ensures armrests properly support forearms, reducing muscular effort in neck and shoulders.



R Arm Rotation
Rotate armcap to support your forearm in various positions. Reduces muscular effort in neck and shoulders, minimizing risk of pain.



S Center-Tilt Movement
Chair tilts from a pivot point under the center of the seat allowing you to rock. When your feet are well supported, blood flow is enhanced.



V Lumbar Depth Adjustment
Increase or decrease curvature of the back to match the profile of your lower back. Enhances comfort and support in the lower lumbar area.

OfficestoGo

2DAY SHIP



2DAY SHIP
MORE TEXTILES

















Best Selling Seating





Custom Shipped in 2 Days!

In addition to these products being INstock and available now, you can customize and have them shipped in as little as 2 business days (\$59 upcharge applies for non-stocked textiles)!

WORK + TASK

 OTG11650 List Price \$273 Stocked in Quilt QL10 Black (maximum 50)	 OTG11651 List Price \$354 Stocked in Quilt QL10 Black (maximum 50)	 OTG11652 List Price \$380 Stocked in Quilt QL10 Black (maximum 50)
 OTG11686 List Price \$462 Stocked in Black Air Mesh Fabric (maximum 50)	 OTG11692 List Price \$482 Stocked in Luxhide BL20 Black (maximum 50)	 OTG11980 List Price \$546 Stocked in Quilt QL10 Black (maximum 50)
 OTG11685 List Price \$520 Stocked in Black Air Mesh Fabric (maximum 50)	 OTG3191 List Price \$578 Stocked in Luxhide BL20 Black (maximum 50)	 OTG11653 List Price \$605 Stocked in Quilt QL10 Black (maximum 50)
 OTG2801 List Price \$632 Stocked in Black Air Mesh Fabric (maximum 50)	 OTG2803 List Price \$659 Stocked in Black Air Mesh Fabric (maximum 50)	 OTG3101 List Price \$707 Stocked in Luxhide BL20 Black (maximum 50)
 OTG11710 List Price \$707 Stocked in Quilt QL10 Black (maximum 50)	 OTG3103 List Price \$744 Stocked in Black Air Mesh Fabric (maximum 50)	 OTG2913 List Price \$792 Stocked in Luxhide BL20 Black (maximum 50)











CONFERENCE + MANAGEMENT

 OTG2788 List Price \$498 Stocked in Luxhide BL20 Black (maximum 50)	 OTG11734* List Price \$519 Stocked in Luxhide BL20 Black (maximum 50) <i>(See note below)</i>	 OTG11735* List Price \$519 Stocked in Luxhide BL20 Black (maximum 50) <i>(See note below)</i>
 OTG2701 List Price \$541 Stocked in Luxhide BL20 Black (maximum 50)	 OTG11786B List Price \$546 Stocked in Luxhide BL20 Black (maximum 50)	 OTG11730** List Price \$557 Stocked in Luxhide BL20 Black and BL28 White (maximum 50) <i>(See note below)</i>
 OTG11732** List Price \$557 Stocked in Luxhide BL20 Black (maximum 50) <i>(See note below)</i>	 OTG2700 List Price \$562 Stocked in Luxhide BL20 Black (maximum 50)	

*These models (OTG11734 + OTG11735) are only available in the following Luxhide colors in the OTG 2 Day Ship Program: Dark Brown (BL24) and White (BL28). All other textiles and Luxhide colors (except stocked BL20, Black) would be subject to "standard" lead times.

**These models (OTG11730 + OTG11732) are only available in the following Luxhide color in the OTG 2 Day Ship Program: Dark Brown (BL24). All other textiles and Luxhide colors (except stocked BL20, Black (OTG11730 + OTG11732) and BL28, White (OTG11730 only)) would be subject to "standard" lead times.

GUEST + STACK

 OTG11934 List Price \$150 Stocked in Quilt QL10 Black (maximum 100)	 OTG11697 List Price \$182 Stocked in Quilt QL10 Black (maximum 100)	 OTG2748 List Price \$193 Stocked in Quilt QL10 Black (maximum 100)
 OTG11704 List Price \$214 Stocked in Quilt QL10 Black (maximum 100)	 OTG11703 List Price \$241 Stocked in Quilt QL10 Black (maximum 100)	 OTG2782 List Price \$428 Stocked in Luxhide BL20 Black (maximum 50)
 OTG11892 List Price \$364 Stocked in Quilt QL10 Black (maximum 50)	 OTG2809 List Price \$487 Stocked in Black Air Mesh Fabric (maximum 50)	 OTG11340B List Price \$424 Stocked in Black Mesh Fabric (maximum 50)
 OTG11341B List Price \$377 Stocked in Black Mesh Fabric (maximum 50)		



Example of 2 Day Ship Seating Pricing:

Model OTG11980
 List Price..... \$546
 Stocked Textile..... QL10
 Custom Textile (BL26) \$59
Total Cost..... \$605

	+ \$59 =	
OTG11980 (QL10) List Price \$546		OTG11980 (BL26) Total Price \$601

- Offices to Go 2 Day Ship Seating Terms and Conditions**
- All models have **MAXIMUM** order quantities which can be fulfilled within the OTG 2 Day Ship program. These are noted below each model. For greater quantities, please contact **CustomerCare** for lead times and terms.
 - Orders must clearly state "OTG 2 Day Ship" at the time of submittal.
 - Program is limited to certain Fabrics and Luxhides shown on pages 204-205
 - Orders cannot be changed or canceled after order acknowledgment.
 - Current Offices to Go list price applies at time of order.
 - All eligible models are UPSable; Offices to Go reserves the right to ship "best way."
 - Order must be clean with correct model numbers, options, textiles, correct pricing, etc. to apply.
 - Dealers must be in good standing and within terms for order to be processed without delay.
 - Program available in the 48 contiguous United States.
 - Order shipment address can be to the dealer or end-user directly.



OfficestoGo Superior Laminate Workspace Solutions

- Five contemporary finishes include Autumn Walnut (AWL), American Mahogany (AML), American Dark Cherry (ADC), American Espresso (AEL) + Artisan Grey (AGL) all accented with 3mm matching impact resistant edges.
- Box and file drawers feature full extension ball bearing drawer slides.
- Lateral files and file/file pedestals come equipped with a mechanical safety interlock.
- Pedestals, lateral files + multi-storage files are designed to connect to the appropriate desk, credenza + return shells.
- Metal pins + cam fasteners are designed for easy assembly (where applicable). Metal brackets (where applicable) are also included for additional strength and rigidity.
- Autumn Walnut (AWL), American Espresso (AEL) + Artisan Grey (AGL) are standard with silver handles. Black handles optional (an upcharge applies - see page 192 for more information).
- American Mahogany (AML) + American Dark Cherry (ADC) are standard with black handles. Silver handles optional (an upcharge applies - see page 192 for more information).

Features



Black grommets are standard on desks, returns, bridges, credenzas, extended corners and hutches. Silver grommets optional (an upcharge applies - see page 191 for SLGRSIL).



Top quality full extension ball bearing slides on all box and file drawers.



Black handles standard on AML + ADC. Silver handles optional (an upcharge applies - see page 192 for SLHDSIL).



Silver handles standard on AWL, AEL + AGL. Black handles optional (an upcharge applies - see page 192 for SLHDBLK).

Available immediately in the following finishes:



AWL Autumn Walnut



AML American Mahogany



ADC American Dark Cherry



AEL American Espresso



AGL Artisan Grey

Boardroom Tables

Select Racetrack or Rectangular Tables.
(see pages 198-199 for more information)



Lighting

Your choice of either LED task light or LED desk lamp.
(see page 187 for more information)



Hutch Door Kits

Laminate (pictured) or silver doors with frosted glass options are available.
(see page 191 for more information)



Height Adjustable Tables

Your choice of six table top sizes.
(see page 194-195 for more information)



Frosted Acrylic Dividers

Your choice of three mounting options.
(see page 187 for more information)

Lighting

Your choice of either LED task light or LED desk lamp.
(see page 187 for more information)

Table Top Bookcase

Specify open (pictured) or select from laminate or silver doors with frosted glass.
(see page 191 for more information)

Hutch Door Kits

Your choice of either laminate (pictured) or silver doors with frosted glass.
(see page 191 for more information)

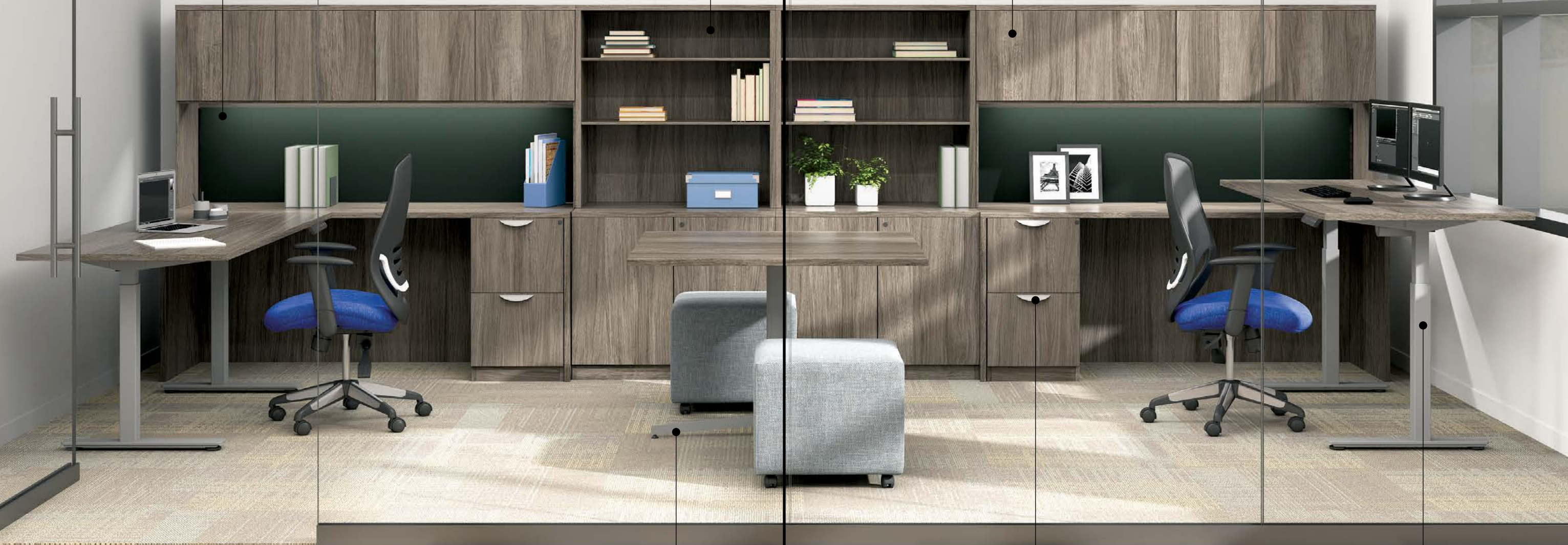

Tables

Square + round tops available in several sizes.
X bases stocked in Black or Tungsten.

Handle Options

Black handles standard on AML + ADC.
Silver handles optional at an upcharge.
Silver handles standard on AWL, AEL + AGL.
Black handles optional at an upcharge.
(see page 192 for more information)

Height Adjustable Tables

Your choice six table top sizes.
(see page 194-195 for more information)



Lighting

Your choice of either LED task light or LED desk lamp. (see page 187 for more information)



Tables

Square + round tops available in several sizes. X bases stocked in Black or Tungsten.

Modular Ottomans

Six geometric shapes can be configured to create infinite and unique layouts with glides or casters.

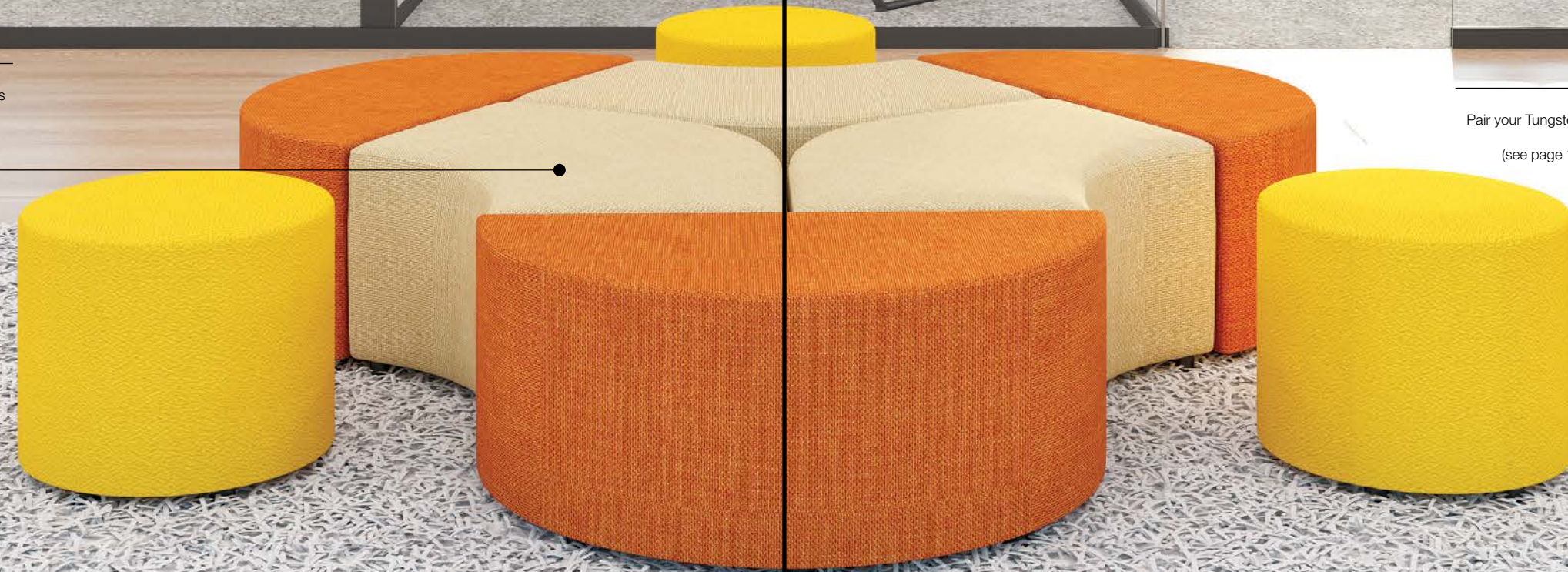

Base Options

Pair your Tungsten or Black 15" post legs with several top choices. (see page 199 for more information)



Dual Spanners
Under worksurface to easily conceal wires.



Modular Ottomans
Standard with 1.5" tall nylon glides. Optional dual wheel casters are available. (see page 141 for more information)



Productivity Solutions



SL20CD
20" Center Drawer
List Price ***132**



SLKB
Keyboard Tray
22.625w x 3d x .6875
List Price ***86**



OTGPCLP1
Shared Surface Edge
Mount Clamp to fit
SLAP48, SLAP60 +
SLAP71
Mounting screws included
List Price ***58** per pair



OTGPCLP2
Edge Mount Clamp to
fit SLAP48, SLAP60 +
SLAP71
Mounting screws included
List Price ***51** per pair



OTGPCLP3
Surface Mount Clamp to
fit SLAP48, SLAP60 +
SLAP71
Mounting screws included
List Price ***34** per pair



SLAP48
Acrylic Panel for 48"
Worksurface
42.5w x 12.5h x .25d
List Price ***167**
2 individual clamps required
per panel



SLAP60
Acrylic Panel for 60"
Worksurface
54.5w x 12.5h x .25d
List Price ***268**
3 individual clamps required
per panel



SLAP71
Acrylic Panel for 71"
Worksurface
66.5w x 12.5h x .25d
List Price ***344**
3 individual clamps required
per panel

Power Solutions



OTGGRSIN-SIL
Grommet with Single
Duplex Power in Silver
Fits all OTG standard
grommets, except
SL7130DS / SL6630DS /
SL6030DS / SL4830DS
List Price ***81**



OTGGRSIN-BLK
Grommet with Single
Duplex Power in Black
Fits all OTG standard
grommets, except
SL7130DS / SL6630DS /
SL6030DS / SL4830DS
List Price ***81**



OTGGRUSB-SIL
Grommet with 2 USB
Power Outlets in Silver
Fits all OTG standard
grommets, except
SL7130DS / SL6630DS /
SL6030DS / SL4830DS
List Price ***162**



OTGGRUSB-BLK
Grommet with 2 USB
Power Outlets in Black
Fits all OTG standard
grommets, except
SL7130DS / SL6630DS /
SL6030DS / SL4830DS
List Price ***162**



OTGLEDLAMP
LED Desk Lamp
List Price ***161**



OTGLEDTL31
31" LED Task Light
All installation hardware
included
List Price ***161**



LAYOUT SL-1		
Model	Description	List Price
SL6030TOP	60" x 30" Rectangular Laminate Top	\$175
SLSB60T	Support Bar	\$44
OTGSTL28	28"H Metal Square Table Leg (#70 each)	\$280
SLAP60	60" Acrylic Panel	\$268
OTGPCLP3	Surface Mount Clamp - Pair	\$34
SL22BFM	22" Mobile Box/File Pedestal with Lock	\$446
Total		\$1247



LAYOUT SL-4		
Model	Description	List Price
SL7124TOP	71" x 24" Rectangular Laminate Top	\$173
SL4824TOP	48" x 24" Rectangular Laminate Top	\$126
SLSB71T	Support Bar	\$53
OTGSTL28	28"H Metal Square Table Leg (#70 each)	\$280
OTGHABASE2	Height Adjustable Table Base	\$742
SLAP71	71" Acrylic Panel	\$344
OTGPCLP3	Surface Mount Clamp - Pair	\$34
SL22BFM	22" Mobile Box/File Pedestal with Lock	\$446
Total		\$2198



LAYOUT SL-7		
Model	Description	List Price
SL6630DS	66" Rectangular Desk Shell	\$351
SL22BBF	22" Box/Box/File Pedestal with Lock	\$382
SL4824TOP	48" x 24" Rectangular Laminate Top	\$126
OTGHABASE2	Height Adjustable Table Base	\$742
SL22BFM	22" Mobile Box/File Pedestal with Lock	\$446
Total		\$2047



LAYOUT SL-10		
Model	Description	List Price
SL6024TOP	60" x 24" Rectangular Laminate Top (#148 each)	\$592
OTGFTBASE60	60" Flip Top Training Table Base (#413 each)	\$1652
OTG11341B	Mesh Back Flip Seat Nesting Chair (#377 each)	\$3016
Total		\$5260



LAYOUT SL-2		
Model	Description	List Price
SL7130TOP	71" x 30" Rectangular Laminate Top	\$206
SLSB71T	Support Bar	\$53
OTGSTL28	28"H Metal Square Table Leg (#70 each)	\$280
OTGPCLP3	Surface Mount Clamp - Pair (#34 each)	\$68
SLAP71	71" Acrylic Panel	\$344
SL22BFM	22" Mobile Box/File Pedestal with Lock (#446 each)	\$892
SL22BBF	22" Box/Box/File Pedestal with Lock	\$382
SL22FF	22" File/File Pedestal with Lock	\$382
SL7124CS	71" Credenza Shell	\$351
SL71HO	71" Open Hutch	\$419
SL71SIDR	Glazed Doors with Silver Frame	\$373
Total		\$3750



LAYOUT SL-5		
Model	Description	List Price
SL4830TOP	48" x 30" Rectangular Laminate Top (#148 each)	\$592
SLSB48T	Support Bar (#35 each)	\$140
OTGSTL28	28"H Metal Square Table Leg (#70 each)	\$700
SLAP48	48" Acrylic Panel (#167 each)	\$334
OTGPCLP1	Shared Surface Edge Mount Clamp - Pair (#58 each)	\$116
SL22BFM	22" Mobile Box/File Pedestal with Lock (#446 each)	\$1784
Total		\$3666



LAYOUT SL-8		
Model	Description	List Price
SL4824TOP	48" x 24" Rectangular Laminate Top (#126 each)	\$504
OTGHABASE2	Height Adjustable Table Base (#742 each)	\$2968
SLAP48	48" Acrylic Panel (#167 each)	\$668
OTGPCLP2	Edge Mount Clamp - Pair (#51 each)	\$204
SL22BFM	22" Mobile Box/File Pedestal with Lock (#446 each)	\$1784
Total		\$6128



LAYOUT SL-11		
Model	Description	List Price
SL14448RECS	144" x 48" Rectangular Conference Table	\$1472
SL3622SC	Storage Cabinet with Lock	\$445
SL3622LF	Lateral File with Lock	\$609
SL7122TOP	Common Top	\$117
SL71BC	71" Bookcase (#422 each)	\$844
SL4848VB	Presentation Board	\$749
Total		\$4236



LAYOUT SL-3		
Model	Description	List Price
SL7130TOP	71" x 30" Rectangular Laminate Top	\$206
SLSB71T	Support Bar	\$53
OTGSTL28	28"H Metal Square Table Leg (#70 each)	\$280
OTGPCLP3	Surface Mount Clamp - Pair (#34 each)	\$68
SLAP71	71" Acrylic Panel	\$344
SL7124CS	71" Credenza Shell	\$351
SL4824TOP	48" Laminate Top	\$126
OTGHABASE2	Height Adjustable Table Base	\$742
SL22BFM	22" Mobile Box/File Pedestal with Lock	\$446
SL22BBF	22" Box/Box/File Pedestal with Lock	\$382
SL71HO	71" Open Hutch	\$419
SL71SIDR	Glazed Doors with Silver Frame	\$373
Total		\$3790



LAYOUT SL-6		
Model	Description	List Price
SL7124CS	71" x 24" Credenza Shell (#351 each)	\$702
SL4824TOP	48" x 24" Rectangular Laminate Top (#126 each)	\$252
SLSB48T	Support Bar (#35 each)	\$70
OTGSTL28	28"H Metal Square Table Leg (#70 each)	\$420
SLAP48	48" Acrylic Panel (#167 each)	\$334
SLAP71	71" Acrylic Panel 2 individual clamps required per panel	\$344
OTGPCLP3	Surface Mount Clamp - Pair (#34 each)	\$136
OTGM393	Flat Bracket (#43 each)	\$86
SL22BFM	22" Mobile Box/File Pedestal with Lock (#446 each)	\$892
SL22FF	22" File/File Pedestal with Lock (#382 each)	\$764
Total		\$4000



LAYOUT SL-9		
Model	Description	List Price
SL6024TOP	60" x 24" Rectangular Laminate Top (#148 each)	\$592
SLSB60T	Support Bar (#44 each)	\$176
OTGSTL28	28"H Metal Square Table Leg (#70 each)	\$1120
OTGSTL4CSTR	Castors - Set of Four (#43 each)	\$172
OTG11341B	Mesh Back Flip Seat Nesting Chair (#377 each)	\$1508
Total		\$3568



LAYOUT SL-12		
Model	Description	List Price
SL9644HT	96" x 44" x 41" High Top Collaboration Table	\$1444
SL3622MSF	Mixed Storage Unit with Lock	\$596
SL3622SC	Storage Cabinet with Lock	\$445
SL7122TOP	Common Top	\$117
SL48BC	48"H Bookcase (#288 each)	\$576
SL71HO	71" Open Hutch	\$419
Total		\$3597

DESKS + WORKSTATIONS



SL7141BDS
Bow Front Desk Shell
71w x 36/42d x 29.5h
List Price ***422**



SL7136DS
71" Rectangular Desk Shell
71w x 36d x 29.5h
List Price ***377**



SL7130DS
71" Rectangular Desk Shell
71w x 30d x 29.5h
List Price ***377**

NEW



SL6630DS
66" Rectangular Desk Shell
66w x 30d x 29.5h
List Price ***351**



SL6030DS
60" Rectangular Desk Shell
60w x 30d x 29.5h
List Price ***320**



SL4830DS
48" Rectangular Desk Shell
48w x 30d x 29.5h
List Price ***306**



SL4824DS
48" Rectangular Desk Shell
48w x 24d x 29.5h
List Price ***304**



SL7148BCL - LIMITED QTY AVAILABLE
Bow Front with Corner Extension - LEFT - Not Freestanding
72w x 30/36/48d x 29.5h
List Price ***550**



SL7148BCR - LIMITED QTY AVAILABLE
Bow Front with Corner Extension - RIGHT - Not Freestanding
72w x 30/36/48d x 29.5h
List Price ***550**



SL4824R
48" Return Shell - REVERSIBLE
48w x 24d x 29.5h
List Price ***235**



SL4820R
48" Return Shell - REVERSIBLE
48w x 20d x 29.5h
List Price ***235**

NEW



SL4224R
42" Return Shell - REVERSIBLE
42w x 24d x 29.5h
List Price ***235**



SL4220R
42" Return Shell - REVERSIBLE
42w x 20d x 29.5h
List Price ***235**

NEW



SL3624R
36" Return Shell - REVERSIBLE
36w x 24d x 29.5h
List Price ***196**

NEW



SL60LDR
Laminate Doors for SL60HO
List Price ***101**

NEW



SL66LDR
Laminate Doors for SL66HO
List Price ***102**

NEW



SL71LDR
Laminate Doors for SL71HO
List Price ***106**

NEW



SLGRBLK
Black Grommet Cover
List Price ***6**



SL3024R - LIMITED QTY AVAILABLE
30" Return Shell - REVERSIBLE
30w x 24d x 29.5h
List Price ***189**



SL7124CS
71" Credenza Shell
71w x 24d x 29.5h
List Price ***351**



SL6624CS
66" Credenza Shell
66w x 24d x 29.5h
List Price ***328**



SL6024CS
60" Credenza Shell
60w x 24d x 29.5h
List Price ***328**

NEW



SL7136DI
"D" Island - Full End Panel + Post (T-Base) - Not Freestanding
71w x 36d x 29.5h
List Price ***386**



SLGRBLK10
Black Grommet Cover - 10 Pack
List Price ***37**



SLGRSIL
Silver Grommet Cover
List Price ***6**



SLGRSIL10
Silver Grommet Cover - 10 Pack
List Price ***37**



SL7136CEL
Credenza with Corner Extension - LEFT - Not Freestanding
71w x 24/36d x 29.5h
List Price ***435**



SL7136CER
Credenza with Corner Extension - RIGHT - Not Freestanding
71w x 24/36d x 29.5h
List Price ***435**



SL71HO
71" Overhead Hutch - OPEN
71w x 15d x 36h
List Price ***419**

NEW



SL71HD
71" Overhead Hutch with Doors
71w x 15d x 36h
List Price ***492**
Limited availability. Check with your local representative.

NEW



SL66HO
66" Overhead Hutch - OPEN
66w x 15d x 36h
List Price ***406**
Fits SL6630DS and SL6624CS only



SL66HD
66" Overhead Hutch with Doors
66w x 15d x 36h
List Price ***467**
Fits SL6630DS and SL6624CS only
Limited availability. Check with your local representative.



SL60HO
60" Overhead Hutch - OPEN
60w x 15d x 36h
List Price ***387**

NEW



SL48HO
48" Overhead Hutch - OPEN
48w x 15d x 36h
List Price ***358**

NEW



SL42425C - LIMITED QTY AVAILABLE
5 Sided Corner
42w x 42d x 29.5h
List Price ***378**



SL36WC
36" w Wall-Mounted Cabinet
36w x 15d x 17h
List Price ***272**



OTGPCLP1
Shared Surface Edge Mount
Clamp to fit SLAP48, SLAP60 + SLAP71 - Pair
Mounting screws included
List Price ***58** per pair

NEW



OTGPCLP2
Edge Mount Clamp to fit SLAP48, SLAP60 + SLAP71 - Pair
Mounting screws included
List Price ***51** per pair

NEW



OTGPCLP3
Surface Mount Clamp to fit SLAP48, SLAP60 + SLAP71 - Pair
Mounting screws included
List Price ***34** per pair

NEW



SLAP48
Acrylic Panel for 48" Worksurface
42.5w x 12.5h x .25d
List Price ***167**
2 individual clamps required per panel

NEW



SLAP60
Acrylic Panel for 60" Worksurface
54.5w x 12.5h x .25d
List Price ***268**
3 individual clamps required per panel

NEW



SL4824FB
48" Flush Bridge
48w x 24d x 29.5h
List Price ***189**



SL4224FB
42" Flush Bridge
42w x 24d x 29.5h
List Price ***189**



SL3624FB - LIMITED QTY AVAILABLE
36" Flush Bridge
36w x 24d x 29.5h
List Price ***166**



SL3024FB - LIMITED QTY AVAILABLE
30" Flush Bridge
30w x 24d x 29.5h
List Price ***155**



SL12G
Half End Panel
12w x 1d x 28h
List Price ***53**



SLAP71
Acrylic Panel for 71" Worksurface
66.5w x 12.5h x .25d
List Price ***344**
3 individual clamps required per panel

NEW



SLSB48T
48" Stiffener Bar for use with corresponding rectangular top when using with OTGSTL28 + OTGSTL15
List Price ***35**

NEW



SLSB60T
60" Stiffener Bar for use with corresponding rectangular top when using with OTGSTL28 + OTGSTL15
List Price ***44**

NEW



SLSB71T
71" Stiffener Bar for use with corresponding rectangular top when using with OTGSTL28 + OTGSTL15
List Price ***53**

NEW



OTGM393
1 Flat Bracket. Used as a mending plate to give additional worksurface support. Mounting screws included.
List Price ***43**

NEW

POWER SOLUTIONS



OTGGRSIN-SIL
Grommet with Single Duplex Power in Silver
Fits all OTG standard grommets, except SL7130DS / SL6630DS / SL6030DS / SL4830DS
List Price **\$81**



OTGGRSIN-BLK
Grommet with Single Duplex Power in Black
Fits all OTG standard grommets, except SL7130DS / SL6630DS / SL6030DS / SL4830DS
List Price **\$81**



OTGGRUSB-SIL
Grommet with 2 USB Power Outlets in Silver
Fits all OTG standard grommets, except SL7130DS / SL6630DS / SL6030DS / SL4830DS
List Price **\$162**



OTGGRUSB-BLK
Grommet with 2 USB Power Outlets in Black
Fits all OTG standard grommets, except SL7130DS / SL6630DS / SL6030DS / SL4830DS
List Price **\$162**



OTGLEDTL31
31" LED Task Light
All installation hardware included
List Price **\$161**



OTGLEDLAMP
LED Desk Lamp
List Price **\$161**

BOOKCASES



SL36HO
36" Table Top Bookcase
36w x 15d x 36h
List Price **\$309**



SL71BC
71" 4 Shelf Bookcase with one fixed shelf and three adjustable shelves
32w x 14d x 71h
List Price **\$422**



SL48BC
48" 2 Shelf Bookcase with two adjustable shelves
32w x 14d x 48h
List Price **\$288**



SL30BC
30" 1 Shelf Bookcase with one adjustable shelf
32w x 14d x 30h
List Price **\$224**

STORAGE OPTIONS



SL22BBF
22"D Box/Box/File Pedestal with Lock
16w x 22d x 28h
List Price **\$382**



SL22FF
22"D File/Box/File Pedestal with Lock
16w x 22d x 28h
List Price **\$382**



SL22BBFM
22"D Mobile Box/Box/File Pedestal with Lock
Not for use with OTGSTL28 + OTGSLBxXT
16w x 22d x 28.5h
List Price **\$554**



SL22BFFM
22"D Mobile Box/Box/File Pedestal with Lock
16w x 22d x 19h
List Price **\$446**



SL22TOP
Top for SL22BBF + SL22FF
List Price **\$50**



SL22HBF
22"D Hanging Box/File Pedestal with Lock
16w x 22d x 19h
List Price **\$272**



SL19HBF
19"D Hanging Box/File Pedestal with Lock
16w x 19d x 19h
List Price **\$272**
Fits SL4220R and SL4820R only



SL3622LF
2 Drawer Lateral File with Lock
36w x 22d x 29.5h
List Price **\$609**



SLCWT
Counterweight for use with SL3622LF
List Price **\$53**



SL3622SC
36" Storage Cabinet with Lock
36w x 22d x 29.5h
List Price **\$445**



SL3622MSF
36" Mixed Storage Unit with Lock
36w x 22d x 29.5h
List Price **\$596**



SL7122TOP
Common Top for use across any combination of SL3622LF, SL3622SC + SL3622MSF
List Price **\$117**



SLHDSIL
Silver Handle
List Price **\$15**

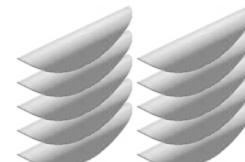

SLHDSIL10
Silver Handle - 10 Pack
List Price **\$108**



SLHDBLK
Black Handle
List Price **\$15**



SLHDBLK10
Black Handle - 10 Pack
List Price **\$108**

COLLABORATION TABLES



SL9644HT
96" High Top Collaboration Table
96w x 44d x 41h
List Price **\$1444**



SL36R
36" Round Table with Cross Base
36w x 29.5h
List Price **\$234**



SL42R
42" Round Table with Cross Base
42w x 29.5h
List Price **\$328**



SL48R - LIMITED QTY AVAILABLE
48" Round Table with Cross Base
48w x 29.5h
List Price **\$377**



SL14448RECS
144" Rectangular Conference Table with Slab Base - Top is standard in 2 pieces - 1 3/8" Top
144w x 48d x 29.5h
List Price **\$1472**



SL12048RECS
120" Rectangular Conference Table with Slab Base - Top is standard in 2 pieces - 1 3/8" Top
120w x 48d x 29.5h
List Price **\$1226**



SL9644RECS
96" Rectangular Conference Table with Slab Base - 1 3/8" Top
96w x 44d x 29.5h
List Price **\$855**



SL7142RECS
71" Rectangular Conference Table with Slab Base - 1 3/8" Top
71w x 42d x 29.5h
List Price **\$659**

CONFERENCE TABLES



SL12048RS
120" Racetrack Conference Table with Slab Base - Top is standard in 2 pieces - 1 3/8" Top
120w x 48d x 29.5h
List Price **\$863**



SL9544RS
95" Racetrack Conference Table with Slab Base - 1 3/8" Top
95w x 44d x 29.5h
List Price **\$585**



SL7136RS
71" Racetrack Conference Table with Slab Base - 1 3/8" Top
71w x 36d x 29.5h
List Price **\$467**



SL4848VB - LIMITED QTY AVAILABLE
Presentation Board - Tackable Black Fabric on Doors
48w x 48h
List Price **\$749**

MEETING TABLE TOPS + BASES



SL36RDTOP
36" Round Laminate Top
List Price **\$170**



SL42RDTOP
42" Round Laminate Top
List Price **\$207**



SL48RDTOP
48" Round Laminate Top
List Price **\$254**



SL4824TOP
48" Rectangular Laminate Top
48w x 24d x 1h
Does not include mounting screws
List Price **\$126**



SL6024TOP
60" Rectangular Laminate Top
60w x 24d x 1h
Does not include mounting screws
List Price **\$148**



SL7124TOP
71" Rectangular Laminate Top
71w x 24d x 1h
Does not include mounting screws
List Price **\$173**



SL4830TOP
48" Rectangular Laminate Top
48w x 30d x 1h
Does not include mounting screws
List Price **\$148**



SL6030TOP
60" Rectangular Laminate Top
60w x 30d x 1h
Does not include mounting screws
List Price **\$175**



SL7130TOP
71" Rectangular Laminate Top
71w x 30d x 1h
Does not include mounting screws
List Price **\$206**



OTGXTB3642
Metal "X" Base to Fit SL36RDTOP, SL42RDTOP, SL36SQTOP + SL42SQTOP - Black or Tungsten - Top mounting screws included
List Price **\$272**



OTGXTB48
Metal "X" Base to Fit SL48RDTOP + SL48SQTOP - Black or Tungsten - Top mounting screws included
List Price **\$345**



OTGSTL28
28"H Metal Square Post Table Leg - Black or Tungsten - Top mounting screws included
27.95h (standard adjustable glides)
29.65h (optional casters)
List Price **\$70**



OTGSTL15
15"H Metal Square Post Table Leg - Black or Tungsten - Top mounting screws included
15.15h (standard adjustable glides)
16.85h (optional casters)
List Price **\$46**



OTGSTL1CSTR
Caster for OTGSTL28 + OTGSTL15
List Price **\$13**



OTGSTL4CSTR
Casters for OTGSTL28 + OTGSTL15 (4 pack)
List Price **\$43**



Height Adjustable Tables

Height Adjustable Table Base



NEW

OTGHABASE2-TUN

Height Adjustable Table Base
Top mounting screws included
List Price **\$742**

FEATURES

- Steel construction with Tungsten finish
- Digital display, 3 programmable positions
- Height adjustment range of 27.8" - 45.5" (includes standard Offices to Go worksurface top)
- Accommodates 24" and 30" depths
- Adjustable to accommodate 48" - 72" widths
- Height adjustment speed of 1" per second
- Single motor
- 2 Legs, dual stage
- Lifting capacity: 220 lbs.
- Power consumption (while active): 115W
- Power consumption (in standby): 0.5W
- Horizontal worksurface support crossbar includes markings to make setting width easy
- Leg Diameter: 2.35" x 2.35"
- Foot Length: 23.25"
- Anti-collision safety feature

Layout Shown in American Mahogany (AML)

Model	Description	List Price
OTGHABASE2-TUN	Height adjustable table base (\$742 each)	\$2968
SL6024TOP	60" Rectangular Laminate Top (\$148 each)	\$592
SLAP60	Acrylic Panel for 60" Worksurface (\$268 each)	\$1072
OTGPCLP3	Surface Mount Clip to fit SLAP60 - Pair (\$34 each)	\$136
SL22BFM	22"D Mobile Box/File Pedestal with Lock (\$446 each)	\$1784
SLHDSIL	Silver Handle (\$15 each)	\$150
OTGLEDLAMP	LED Desk Lamp (\$161 each)	\$483
Total		\$7185

Seating shown



OTG11647B
(page 107)

Laminate Table Tops*



SL4824TOP

Rectangular Laminate Top
Dimensions: 48w x 24d x 1h
List Price **\$126**

SL6024TOP

Rectangular Laminate Top
Dimensions: 60w x 24d x 1h
List Price **\$148**

SL7124TOP

Rectangular Laminate Top
Dimensions: 71w x 24d x 1h
List Price **\$173**

SL4830TOP

Rectangular Laminate Top
Dimensions: 48w x 30d x 1h
List Price **\$148**

SL6030TOP

Rectangular Laminate Top
Dimensions: 60w x 30d x 1h
List Price **\$175**

SL7130TOP

Rectangular Laminate Top
Dimensions: 71w x 30d x 1h
List Price **\$206**

Laminate Table Tops Available immediately in the following finishes:



AWL Autumn Walnut

AML American Mahogany

ADC American Dark Cherry

AEL American Espresso

AGL Artisan Grey

*Screws not included with tops

Components shown



OTGHABASE2-TUN



SL6024TOP



SL22BFM



OTGLEDLAMP



SLHDSIL



OTGPCLP3



SLAP60

Accessories shown



Flip Top Training Tables

Flip Top Training Table Bases



NEW

OTGFTBASE48
48" Flip Top Training Table Base
List Price **\$373**

OTGFTBASE60
60" Flip Top Training Table Base
List Price **\$413**

OTGFTBASE71
71" Flip Top Training Table Base
List Price **\$431**

FEATURES

- Single lever activates flip top / nesting mechanism
- Accommodates 24" & 30" deep tops
- Equipped with 4 locking casters
- Modesty panel included
- Black (BLK) or Tungsten (TUN) finishes available
- Table top mounting screws included with base

Layout Shown in Artisan Grey (AGL)

Model	Description	List Price
OTGFTBASE60	60" Flip Top Training Table Base	\$413
SL6024TOP	60" Rectangular Laminate Top	\$148
Total		\$561

Components shown



OTGFTBASE60



SL6024TOP

Seating shown



OTG11341B
(page 150)



OTG13050B
(page 146)

Laminate Table Tops*



SL4824TOP

Rectangular Laminate Top
Dimensions: 48w x 24d x 1h
List Price **\$126**

SL6024TOP

Rectangular Laminate Top
Dimensions: 60w x 24d x 1h
List Price **\$148**

SL7124TOP

Rectangular Laminate Top
Dimensions: 71w x 24d x 1h
List Price **\$173**

SL4830TOP

Rectangular Laminate Top
Dimensions: 48w x 30d x 1h
List Price **\$148**

SL6030TOP

Rectangular Laminate Top
Dimensions: 60w x 30d x 1h
List Price **\$175**

SL7130TOP

Rectangular Laminate Top
Dimensions: 71w x 30d x 1h
List Price **\$206**

Laminate Table Tops Available immediately in the following finishes:



AWL Autumn Walnut



AML American Mahogany



ADC American Dark Cherry



AEL American Espresso



AGL Artisan Grey

*Screws not included with tops



Conference + Meeting Tables

Square Meeting Table Tops

NEW

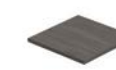

SL24SQTOP
24" Square Laminate Top
24w x 24d
List Price ***93**



SL36SQTOP
36" Square Laminate Top
36w x 36d
List Price ***170**



SL42SQTOP
42" Square Laminate Top
42w x 42d
List Price ***207**



SL48SQTOP
48" Square Laminate Top
48w x 48d
List Price ***254**

Round Meeting Table Tops

NEW



SL36RDTOP
36" Round Laminate Top
List Price ***170**



SL42RDTOP
42" Round Laminate Top
List Price ***207**



SL48RDTOP
48" Round Laminate Top
List Price ***254**

Rectangular Top Conference Tables

NEW



SL14448RECS
144" Rectangular Conference Table with Slab Base - Top is standard in 2 pieces - 1 3/8" Top
List Price ***1472**



SL12048RECS
120" Rectangular Conference Table with Slab Base - Top is standard in 2 pieces - 1 3/8" Top
List Price ***1226**



SL9644RECS
96" Rectangular Conference Table with Slab Base - 1 3/8" Top
List Price ***855**



SL7142RECS
71" Rectangular Conference Table with Slab Base - 1 3/8" Top
List Price ***659**

Racetrack Top Conference Tables



SL12048RS
120" Racetrack Conference Table with Slab Base - Top is standard in 2 pieces - 1 3/8" Top
List Price ***863**



SL9544RS
95" Racetrack Conference Table with Slab Base - 1 3/8" Top
List Price ***585**



SL7136RS
71" Racetrack Conference Table with Slab Base - 1 3/8" Top
List Price ***467**

Round Meeting Tables with Cross Base



SL36R
36" Round Table with Cross Base
List Price ***234**



SL42R
42" Round Table with Cross Base
List Price ***328**



SL48R
48" Round Table with Cross Base
List Price ***377**

Rectangular Meeting Table Tops*



SL4824TOP
48" Rectangular Laminate Top
List Price ***126**



SL6024TOP
60" Rectangular Laminate Top
List Price ***148**



SL7124TOP
71" Rectangular Laminate Top
List Price ***173**



SL4830TOP
48" Rectangular Laminate Top
List Price ***148**



SL6030TOP
60" Rectangular Laminate Top
List Price ***175**



SL7130TOP
71" Rectangular Laminate Top
List Price ***206**

Metal Bases**

NEW



OTGXTB3642
Metal "X" Base to Fit SL36RDTOP, SL42RDTOP, SL36SQTOP + SL42SQTOP - Black or Tungsten - Top mounting screws included
List Price ***272**



OTGXTB48
Metal "X" Base to Fit SL48RDTOP + SL48SQTOP - Black or Tungsten - Top mounting screws included
List Price ***345**



OTGSTL28
28"H Metal Square Post Table Leg - Black or Tungsten - Top mounting screws included
27.95h (standard adjustable glides) 29.65h (optional casters)
List Price ***70**



OTGSTL15
15"H Metal Square Post Table Leg - Black or Tungsten - Top mounting screws included
15.15h (standard adjustable glides) 16.85h (optional casters)
List Price ***46**

Accessory

NEW



OTGM393
1 Flat Bracket. Used as a mending plate to give additional worksurface support. Mounting screws included.
List Price ***43**

Available immediately in the following finishes:



AWL Autumn Walnut



AML American Mahogany



ADC American Dark Cherry



AEL American Espresso



AGL Artisan Grey

*Screws not included with tops

**Mounting screws for tops included with base



Collaboration Table



NEW

SL9644HT

96" High Top Collaboration Table
 Dimensions: 96w x 44d x 41h -
 1 3/8" Top and Side Panels.
 List Price ***1444**

Suggested seating applications:



OTG11343B with OTG11600 Stool Kit (page 171)



OTG11650B with OTG11600 Stool Kit (page 171)



OTG11642B with OTG11600 Stool Kit (page 171)



OTG11922B with OTG11600 Stool Kit (page 171) - pictured left

Available immediately in the following finishes:



AWL Autumn Walnut



AML American Mahogany



ADC American Dark Cherry



AEL American Espresso



AGL Artisan Grey

quick ship textiles



QUILT - Grade 1 100% Polyester
Available on GLOBAL and Offices to Go seating.



JENNY - Grade 1 100% Polyester
Available on GLOBAL and Offices to Go seating.



FUSION - Grade 1 90% Virgin Polyester, 10% Post Consumer Recycled Polyester
Available on GLOBAL and Offices to Go seating.



NEW TEXTILE

ILLUSION - Grade 1 100% Virgin Polyester
Available on GLOBAL and Offices to Go seating.

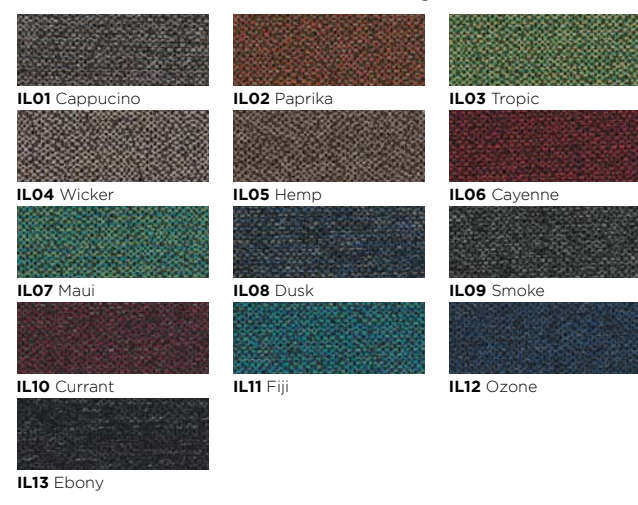

TERRACE - Grade 1 70% Virgin Polyester / 30% Post-Consumer Recycled Polyester
Available on GLOBAL and Offices to Go seating.



CARRERA - Grade 1 100% Olefin
Available on GLOBAL and Offices to Go seating.



WATERFALL - Grade 1 60% Virgin Polyester / 40% Post-Consumer Recycled Polyester
Available on GLOBAL and Offices to Go seating.



NEW TEXTILE

WAVELENGTH - Grade 1 100% Virgin Polyester
Available on GLOBAL and Offices to Go seating.



URBAN - Grade 1 62% Recycled Polyester / 32% Polyester
Available on GLOBAL and Offices to Go seating.



HUDSON - Grade 1 100% Post Consumer Recycled Polyester
Available on GLOBAL and Offices to Go seating.



ELEVATE - Grade 2 80% Post-Consumer Recycled Polyester / 20% Rayon
Available on GLOBAL seating only.



IMPRINT - Grade 2 100% Post-Consumer Recycled Polyester / Stain Repellent Finish
Available on GLOBAL seating only.



MATCH - Grade 2 100% Recycled Polyester
Available on GLOBAL seating only.



SILHOUETTE - Grade 2 100% Nylon / Stain Repellent Finish
Available on GLOBAL seating only.



REPLAY - Grade 2 100% Post-Consumer Recycled Polyester / Stain Repellent Finish
Available on GLOBAL seating only.



ETCH - Grade 2 80% Post-Consumer Recycled Polyester / 20% Rayon
Available on GLOBAL seating only.



COUTURE - Grade 2 100% Post-Consumer Recycled Polyester
Available on GLOBAL seating only.



GC LINEN - Grade 2 100% Vinyl
Available on GLOBAL seating only.



NEW TEXTILE

ALLANTE FREE - Grade 2 100% Vinyl (Face) / 100% Polyester (Back)
Available on GLOBAL and Offices to Go seating.



LEATHER/MOCK LEATHER - Grade 5 100% Leather / 100% Polyvinyl Chloride
Available on GLOBAL seating only.



GENUINE LEATHER - Grade 8 100% Leather
Available on GLOBAL seating only.



RELEASE - Grade 2 100% Vinyl
Available on GLOBAL seating only.



LUXHIDE Luxhide is a bonded leather consisting of 15% leather fibers
Available on Offices to Go seating only.

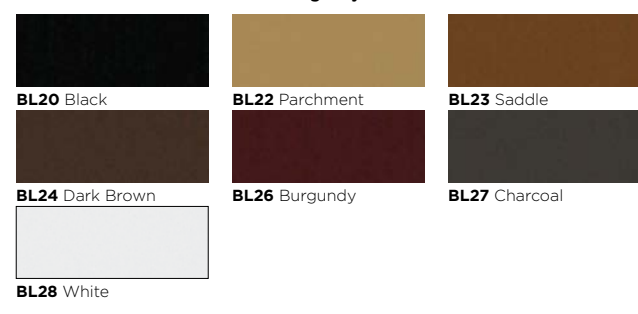

GLOBAL SEATING

Arno
 4003..... 32
 4004..... 32

Aspen

2851-3* 12
 2852-3..... 12

Bakhita

6750..... 38
 6751..... 38
 6754..... 38
 6756..... 38

Citi

7875* 35
 7876* 34-35
 7877* 35
 7885* 35

Concorde

2424-18* 33

Height Adjustable Stool Kit

2241..... 31
 2243..... 31

Duet

6620* 45
 6621..... 45
 6624..... 45

Factor

5440..... 5, 6-7
 5541..... 6-7

File Buddy

1105..... 91

G1 Ergo Select

7331..... 14, 72-73
 7332..... 4, 14, 74-75

Global Accord

2670-4 26
 2671-4..... 26

Goal

2236-6 31
 2237-3 22
 2237-5 22
 2237-6 22
 2239-6 22, 76-77

Graham

3144..... 23

Granada

3212 15
 3217 15

Graphic

2738MB 20

Loover

2661-8..... 18
 2662-8 18

Luray

6461..... 27
 6462..... 27

Popcorn

6710* 43
 6711* 43
 6715 43
 6716 43

Roma

1906 19, 79
 1899 19, 41

Sidero

6900 42
 6901 42

Solar

8456..... 29
 8457 25, 28, 29, 84-85

Sonic

6508 44
 6513 44

Spyker

6790* 39
 6791 39
 6756 39

Spritz

6765C..... 36-37, 40

Synopsis

5080-3* 13
 5081-3* 13
 5090-4 30
 5091-4 30

Truform

5450-3 16
 5451-3..... 16
 5450-8 16
 5451-8 16
 TS5450-3 17
 TS5451-3 17
 S5458-6 17, 31

Tye

1950-4 21
 1951-4 21

Vion Fog

6321-0-OFAFG 11
 6322-0-OFAFG 10-11
 6325FO 11

Vion

6321-4(C)..... 9
 6321-8..... 9
 6322-8..... 9

GLOBAL WORKSPACE + MEETING AREAS

Bakhita Tables..... 38, 83
 Boardroom Tables..... 84-85
 Foli Height Adjustable
 Tables 31, 80-81, 83
 Genoa Desking 72-79
 Intelli Beam..... 80-81
 Lite Lift II Tables..... 85
 Swap Tables 82
 Zira Desking 64-71

GLOBAL FILING + STORAGE

1900 Series Pedestals 91
 1900 Plus Lateral Files 90
 2500 Vertical Files..... 91
 9300 Plus Lateral Files..... 90
 File Buddy 1105..... 91
 Storage Cabinets..... 91

OFFICES TO GO SEATING

GC3010 153
 OTG10700 171
 OTG10701 171
 OTG1220B 155
 OTG1221B 155
 OTG2700 123
 OTG2701 123
 OTG2748 153
 OTG2782 123, 145
 OTG2788 126
 OTG2801 98-99
 OTG2803 99
 OTG2809 144
 OTG2821 99
 OTG2913 96
 OTG3101 97
 OTG3103 97
 OTG3191 100
 OTG3915B 149
 OTG3918B 147
 OTG10900B 133
 OTG10901B 132
 OTG10902B 133
 OTG10904B 110
 OTG11300B 121
 OTG11310B 154
 OTG11311B 154
 OTG11312 154
 OTG11313 154
 OTG11320B 114
 OTG11325B 100
 OTG11328B 111
 OTG11340B* 150
 OTG11341B 150
 OTG11343B 117
 OTG11512B 144
 OTG11514B 108
 OTG11516B 108
 OTG11600 107, 116, 117, 136, 137
 OTG11620 107, 116, 117, 136, 137
 OTG11612B 115
 OTG11617B 130
 OTG11618B 121
 OTG11631B 111
 OTG11641B 107
 OTG11642B 107, 116
 OTG11647B 107
 OTG11648B 120
 OTG11650 117
 OTG11651 105

OTG11652 105
 OTG11653 104
 OTG11657B 127
 OTG11685B 103
 OTG11686B 103
 OTG11692 101
 OTG11697 152
 OTG11698 152
 OTG11700 155
 OTG11701 153
 OTG11703 152
 OTG11704 152
 OTG11705 153
 OTG11706 152
 OTG11710 96
 OTG11715B 114
 OTG11730B 125
 OTG11732 125
 OTG11734B 125
 OTG11735 125
 OTG11740B 147
 OTG11750B 132
 OTG11760B 151
 OTG11761B 151
 OTG11769B 108
 OTG11770B(CX) 149
 OTG11770B(ES) 149
 OTG11776B 131
 OTG11782B 131
 OTG11786B 129
 OTG11790B 126
 OTG11820B(CX) 145
 OTG11820B(TH) 145
 OTG11850B 115
 OTG11858B 120
 OTG11865B 109
 OTG11892 150
 OTG11920B 113, 148
 OTG11921B 113, 148
 OTG11922B 113, 116, 148
 OTG11923B 113, 148
 OTG11924 113, 116, 136, 148
 OTG11934 153
 OTG11950B 110
 OTG11975B 130
 OTG11980B 101
 OTG12110B 104
 OTG12112B 109
 OTG13007 141
 OTG13008 141
 OTG13009 141

OTG13010 141
 OTG13011 141
 OTG13012 141
 OTG13026B 135
 OTG13050B 135, 146
 OTG13050BT 135, 146
 OTG5001NA* 139
 OTG5002 139
 OTG5002C 139
 OTG5003 139
 OTG5004 139
 OTG5011 139

OFFICES TO GO WORKSPACE SOLUTIONS

Collaboration Tables 200-201
 Conference +
 Meeting Tables 127, 198-199
 Flip Top Training Tables 196-197
 Height Adjustable Tables 194-195
 Superior Laminate Workspace
 Solutions 176-193

*Not UPSable

All Global dimensions are shown in inches. Prices shown are current manufacturer's suggested list price at the time of printing. All applicable taxes are extra. Descriptions, specifications and prices are subject to change without notice. Errors and omissions are subject to correction. Color samples depicted in this book are as close to actual as modern printing processes will allow.

All Offices To Go dimensions are nominal. Prices shown are current manufacturer's suggested list price at the time of printing. All applicable taxes are extra. Descriptions, specifications and prices are subject to change without notice. Errors and omissions are subject to correction. Color samples depicted in this book are as close to actual as modern printing processes will allow.

*Not UPSable

National Stocking + 2 Day Ship Express Programs



OfficestoGo



globalfurnituregroup.com
OfficestoGo.com

Effective April 2020

Updated 010122