

NL36H0

Assembly Instructions

Thank you for purchasing this product from Global. Before you begin assembly, check that you have all the parts and hardware shown on this page.

If there is any item missing, circle the item, indicating quantity required and return to us by fax or mail:

CANADA

Global Upholstery
560 Supertest Road
Downsview, Ont.
M3J 2M6
TEL. (416)661-3660
FAX. (416)661-4300
Attn.: Customer Service

US

Global Industries Inc.
17 West Stow ROAD
P.O. 524
Marlton, NJ 08053
TEL. (856)596-3390
FAX. (856)596-5684
Attn.: Customer Service

TOOLS REQUIRED

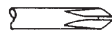

PHILLIPS
Screwdriver size #2



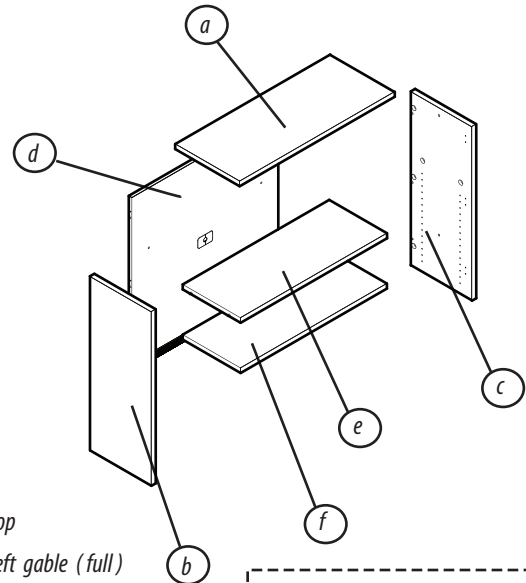



It is advisable to assemble unit on a carpet to avoid scratches.

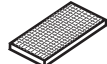
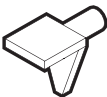
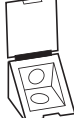
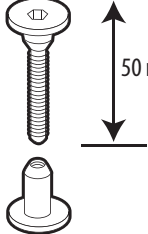

- a. Top
- b. Left gable (full)
- c. Right gable (full)
- d. Back
- e. Fixed Shelf
- f. Shelf

Notice to installers:
Open and assemble only one product at a time to avoid a potential mix up of parts and hardware.

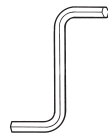
NAIN 22 rev: 00

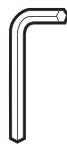
<p>GEN160 Rectangular Grommet</p>  <p>X 1</p>	<p>FST 007 Wood Dowel 8mm dia x 30mm</p>  <p>X 6</p>	<p>ADH046 DOUBLE SIDED TAPE 3/4" x 1 1/2" x 1mm WHITE with YELLOW liner</p>  <p>X 4</p>	<p>ADH024 Non Skid Tape, Die Cut</p>  <p>X 4</p>	<p>GEN063 Shelf Support</p>  <p>X 4</p>	<p>GEN354 CORNER BRACKET 1 3/4" x 1" x 1"</p>  <p>x 2</p>	<p>FST008 FST009 GANGING CONNECTOR Bolt 1/4-20 x 50mm Cap 1/4-20 x 17mm 17/9.5 dia</p>  <p>50 mm</p> <p>WARNING</p> <p>x 2</p>
<p>FST 034 Confirmat 50 Hex</p>  <p>X 2</p>	<p>GEN 073 Allen Key</p>  <p>X 1</p>	<p>FST135</p>  <p>X 4</p>	<p>GEN227 ALLEN KEY, "L" SHAPE, SWS</p>  <p>X 1</p>			<p>Use supplied ganging connector (50 mm) only to attach to other units with 1" gables, such as: End shelves, Hutches and Overhead storages. To attach to units with 11/16" gables, use the ganging connector (35mm) packed with those units</p>

Step **1**

Install and tighten (2) blum connectors

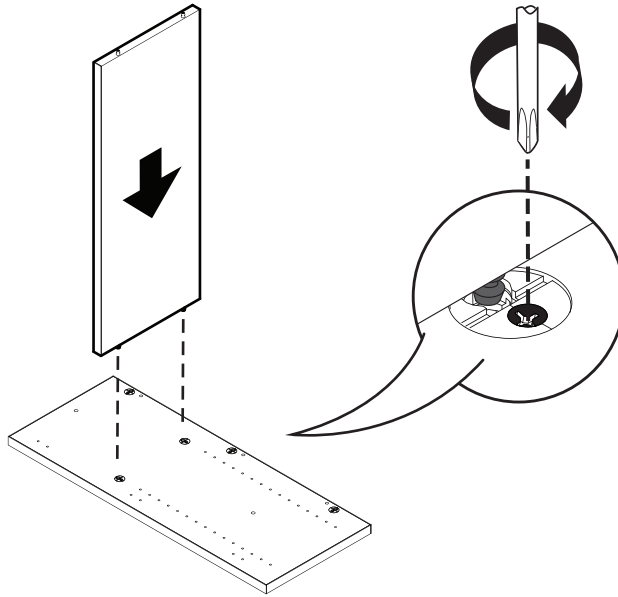

Step **2a**



X 3

Install and tighten (3) blum connectors

Install (3) Wood Dowels

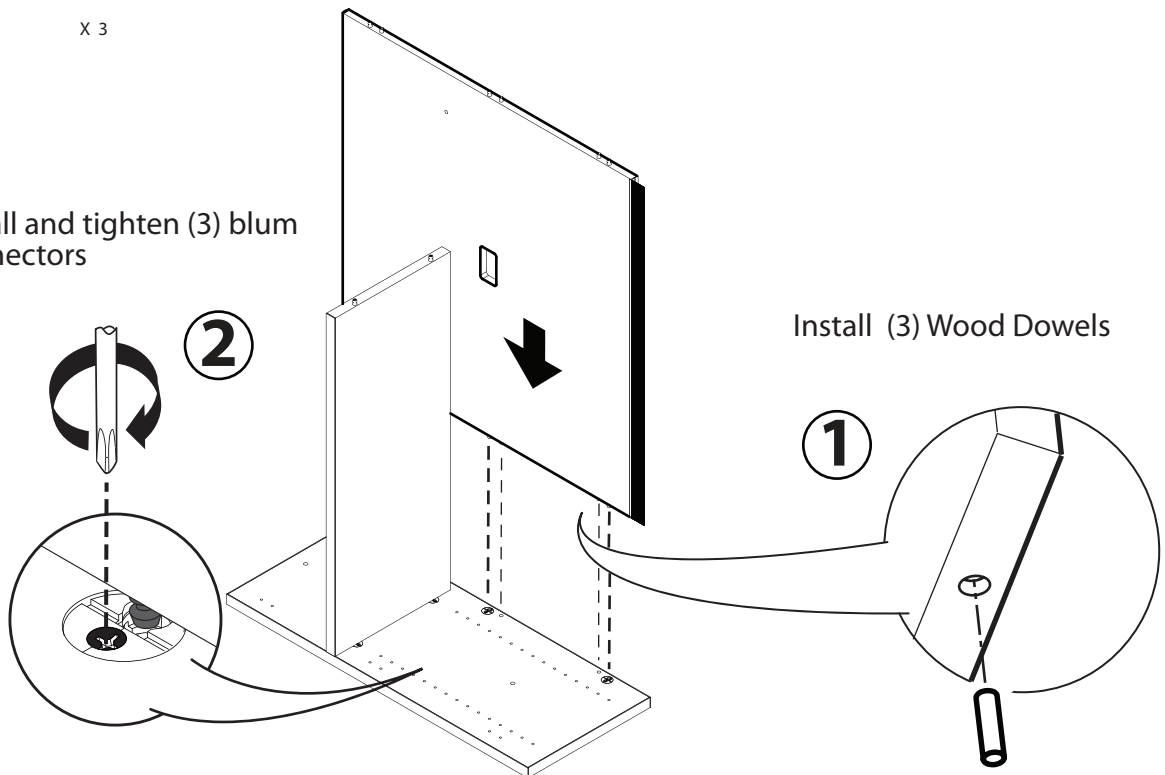

Step **2b**

FST 034
Conformat 50 Hex

GEN 073



X 2



X 1

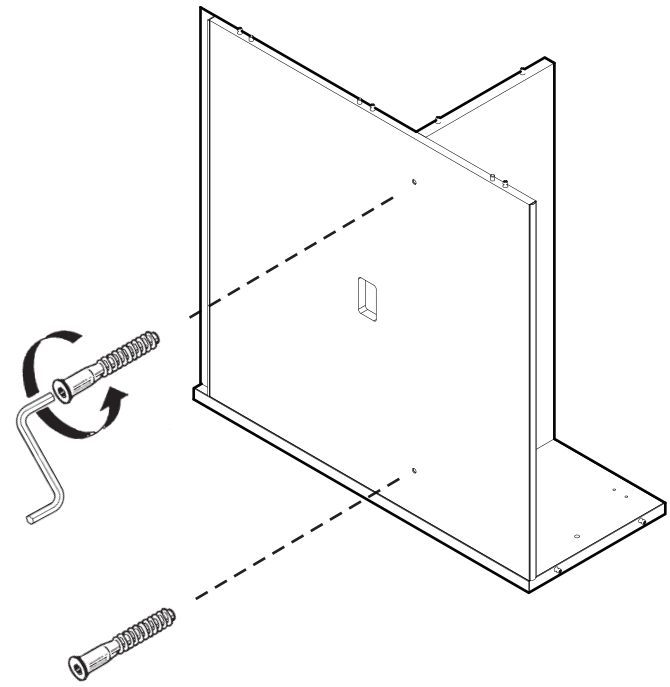

Step **3**

1

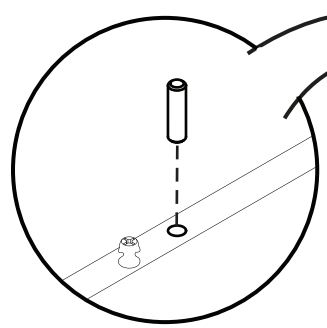

Install (3) Wood Dowels

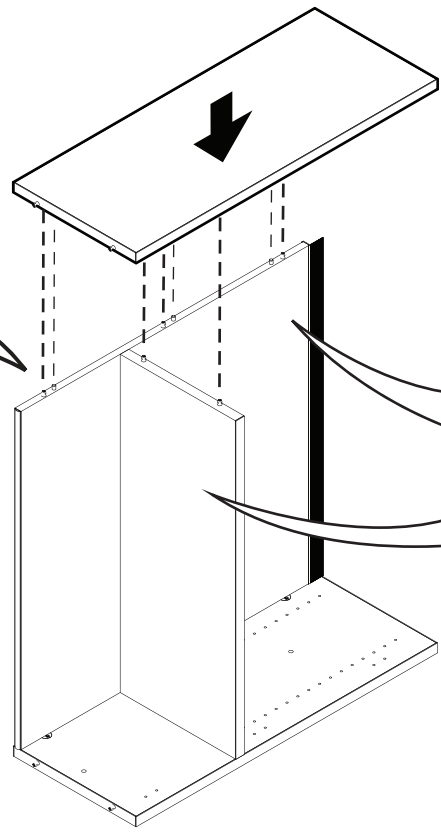

2

Install and tighten (5) blum connectors

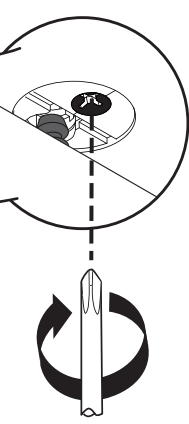

Step **4**

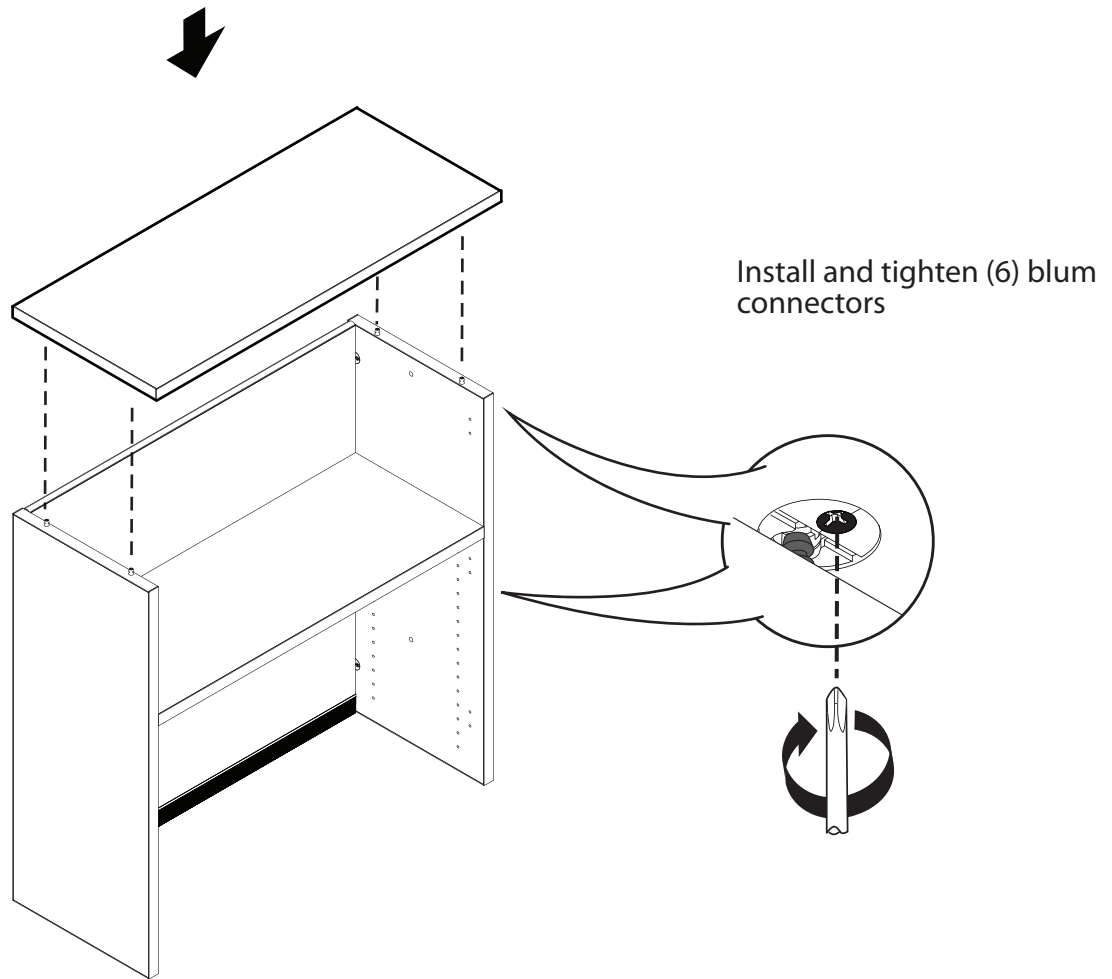

Step **5**

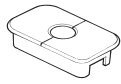

x 1

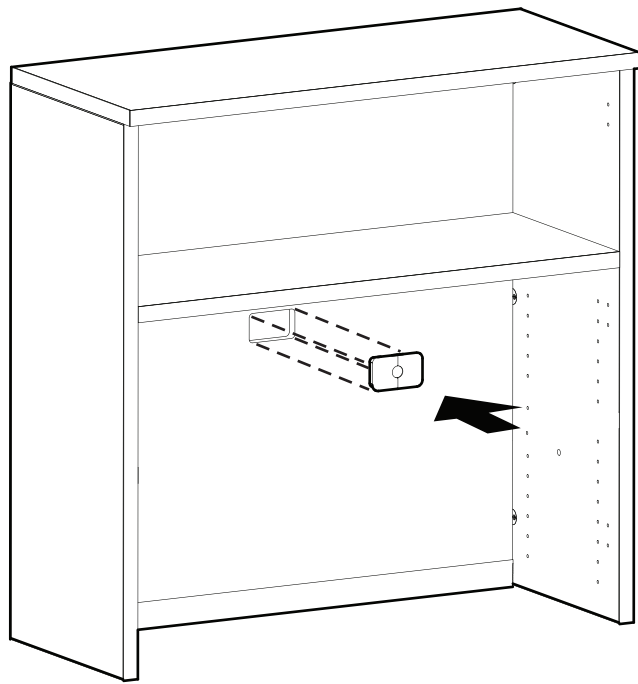

OPTION a

PERMANENT INSTALLATION
DOUBLE SIDE TAPE

Step 6a

ADH046



X 4

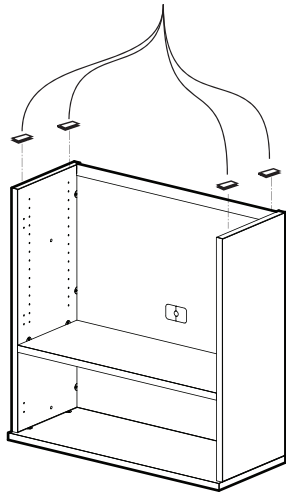
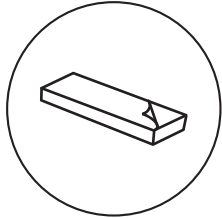
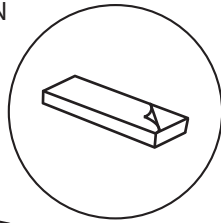

OPTION b

SEMI-PERMANENT INSTALLATION
NON-SKID TAPE

Step 6b

ADH024



X 4

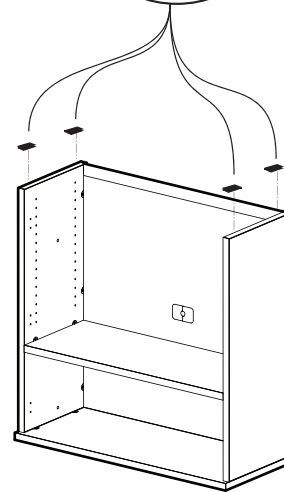
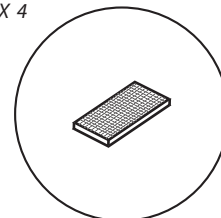
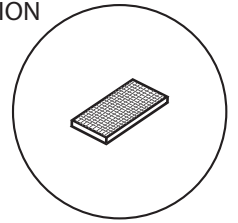

Step 7a



For permanent attachment to TABLE,
remove paper liner from adhesive strip
on bottom of GABLES. Carefully align HUTCH
into position on TABLE. Press down on HUTCH.

NOTE: Once adhesive is activated,
HUTCH CANNOT BE RE- POSITIONED.

Step 7b



For semi-permanent attachment to TABLE,
carefully align HUTCH
into position on TABLE.

Step **8**

FST008
FST009
x 2

ADH026
x 8
as required

GEN227
x 1



Use supplied ganging connector (50 mm) **only** to attach to other units with 1" gables, such as: End shelves, Hutches and Overhead storages.
To attach to units with 11/16" gables, use the ganging connector (35mm) **packed with those units**

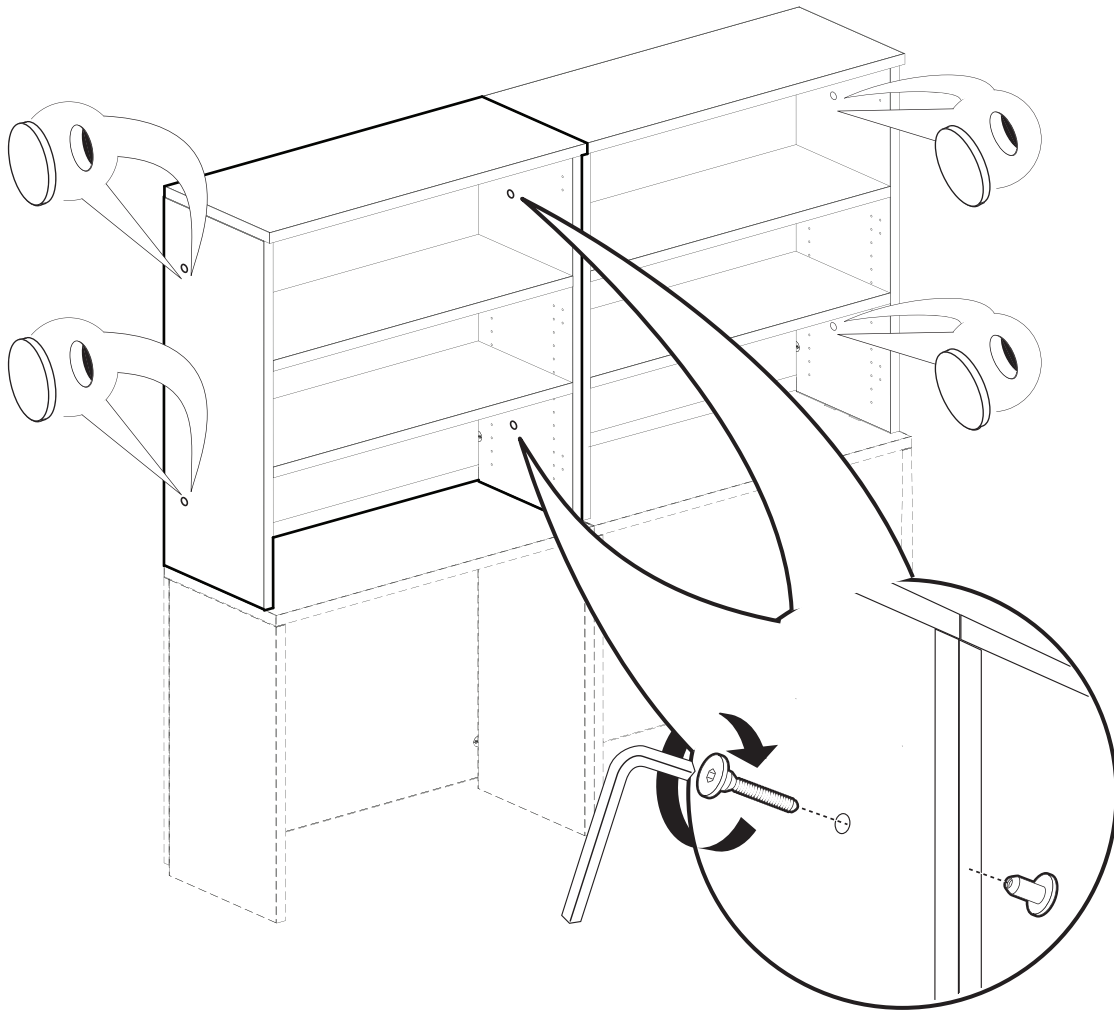

Step **9**

GEN354

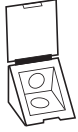

x2

FST135



x4

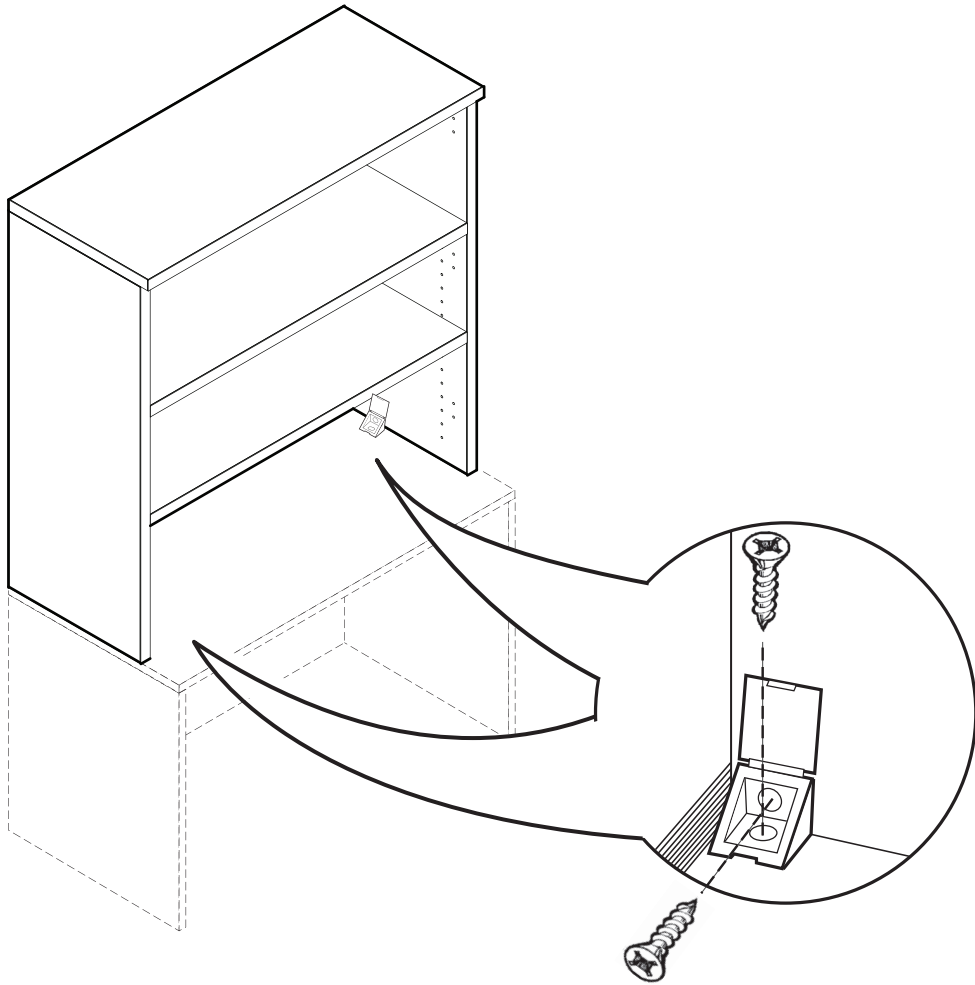

Step **10**

GEN063



X 4

