











## Reception Return - Reversible

LO2/08-22

CONC10	CONC11	DOWEL	GLIDE	TUN013LB	TUN018SC	TUN015BG	PLASTIC CAP	TUN019SC	PLUG
<b>A</b>  Cam Lock Pin 8Pcs+2Pcs	<b>B</b>  Cam Lock 8Pcs+2Pcs	<b>C</b>  Dowel 3Pcs+1Pcs	<b>D</b>  Glide 4Pcs	<b>E</b>  L-Bracket 3Pcs	<b>F</b>  Screw #4*1/2 36Pcs+5Pcs	<b>G</b>  Grommet 1Pcs	<b>H</b>  DEEP CAMLOCK CAP 8Pcs+8Pcs	<b>I</b>  Flat Bracket 3Pcs	<b>J</b>  CAP FOR METAL INSERT 4Pcs

### STEP1

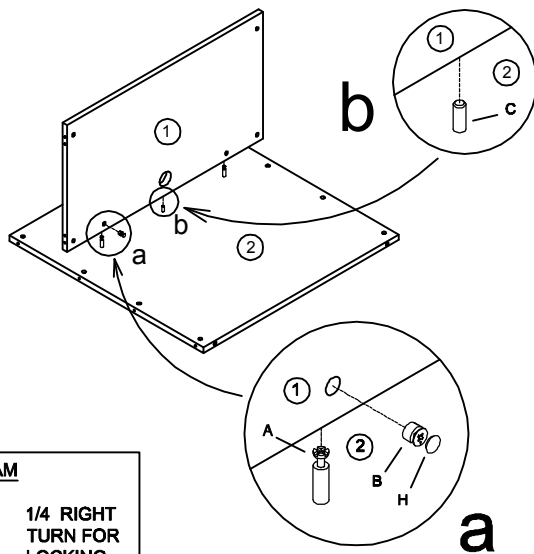

**IMPORTANT:**

**FUNCTION OF CAM**



1/4 RIGHT  
TURN FOR  
LOCKING

MAKE SURE THE ARROW IS POINTING UPWARDS  
BEFORE INSERTING INTO THE PANEL'S HOLE.

### STEP2

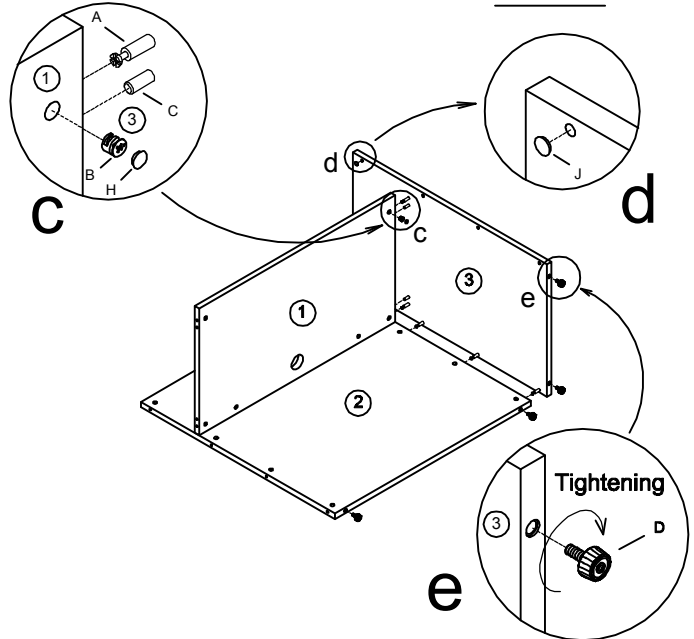

### STEP3

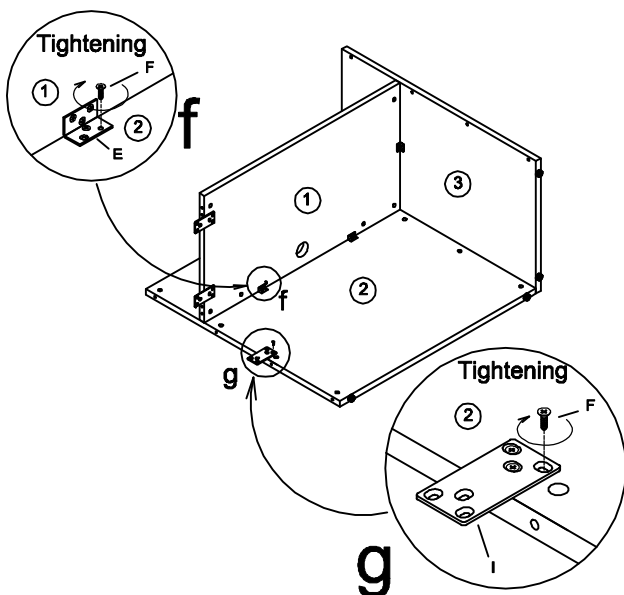

### STEP4

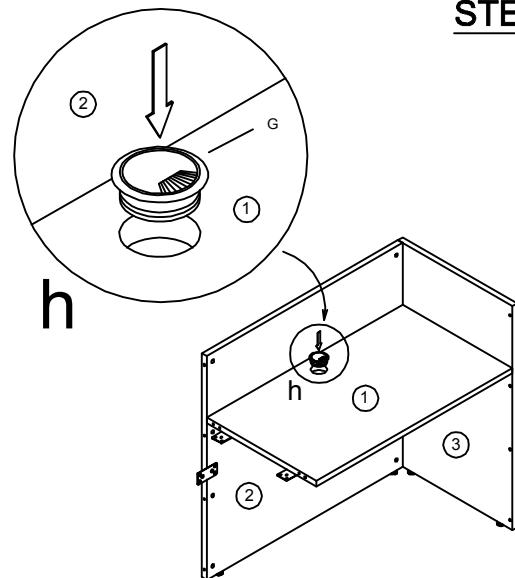

**COMPLETED ASSEMBLY**

### IMPORTANT NOTE:

- It is advisable to assemble unit on a carpet to avoid scratch.
- Check to be sure that you have all parts and hardware.
- Don't tighten all screws/bolts until all completely assembled.
- It is recommended to require 2 persons to complete the assembling.