







Round Table

LO2/08-22

CONC10	CONC11	DOWEL	GLIDE	TUN013LB	TUN018SC	PLASTIC CAP
A  Cam Lock Pin 8Pcs+2Pcs	B  Cam Lock 8Pcs+2Pcs	C  Dowel 2Pcs+1Pcs	D  Glide 4Pcs	E  L-Bracket 4Pcs	F  Screw #4*5/8" 24Pcs+5Pcs	G  DEEP CAMLOCK CAP 8Pcs+2Pcs

STEP1

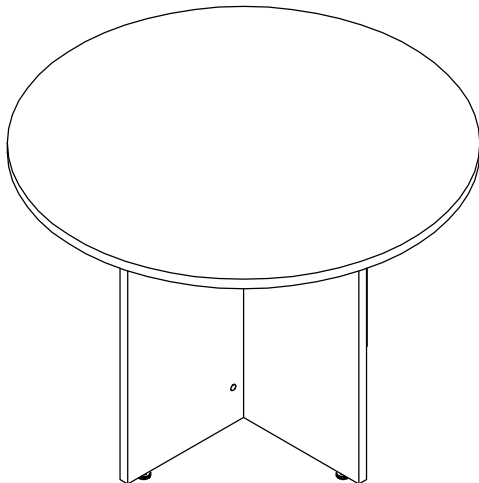
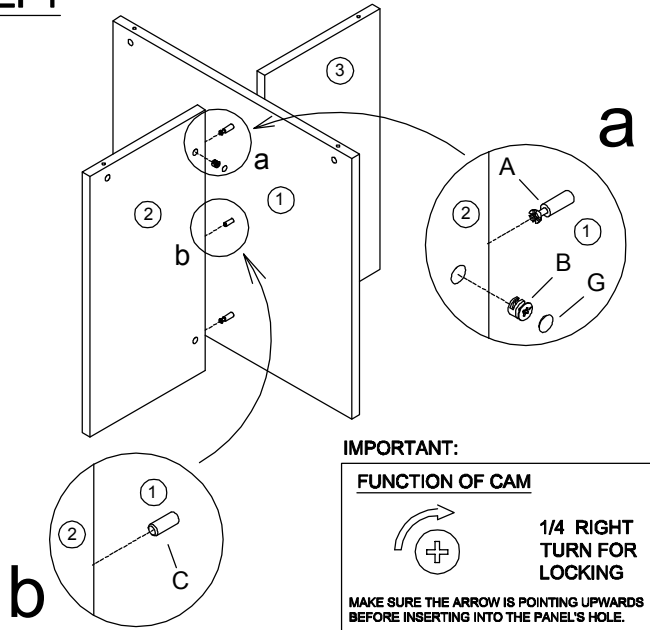

COMPLETED ASSEMBLY

STEP2

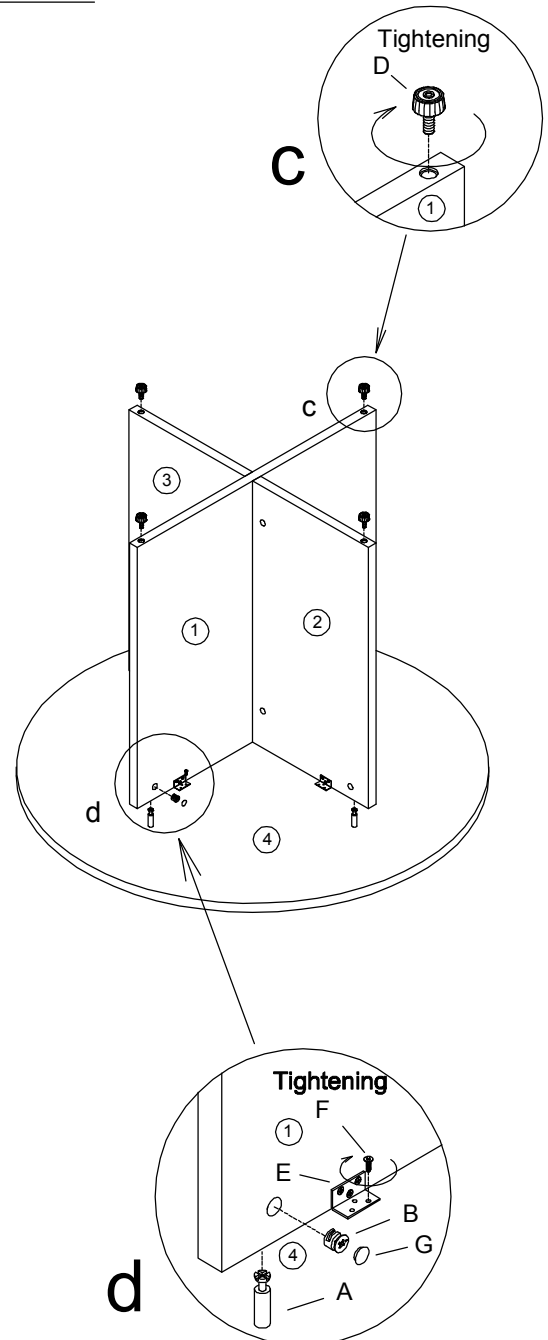

IMPORTANT NOTE:

- It is advisable to assemble unit on a carpet to avoid scratch.
- Check to be sure that you have all parts and hardware.
- Don't tighten all screws/bolts until all completely assembled.
- It is recommended to require 2 persons to complete the assembling.