







Bookcase

LO2/08-22

CONC10	CONC11	DOWEL	GLIDE	TUN020SD	PLASTIC CAP	PLASTIC CAP
A  Cam Lock Pin 18Pcs+2Pcs	B  Cam Lock 18Pcs+2Pcs	C  Dowel 12Pcs+2Pcs	D  Glide 4Pcs	E  Shelf dowel 8Pcs+2Pcs	F  DEEP CAMLOCK CAP 9Pcs+1Pcs	G  CAMLOCK CAP 9Pcs+1Pcs

STEP1

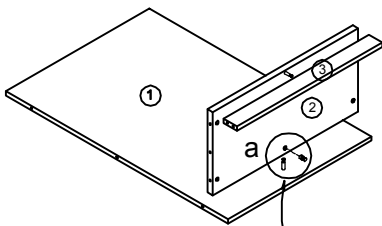

IMPORTANT:

FUNCTION OF CAM



1/4 RIGHT
TURN FOR
LOCKING

MAKE SURE THE ARROW IS POINTING UPWARDS
BEFORE INSERTING INTO THE PANEL'S HOLE.

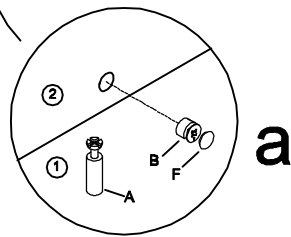

STEP2

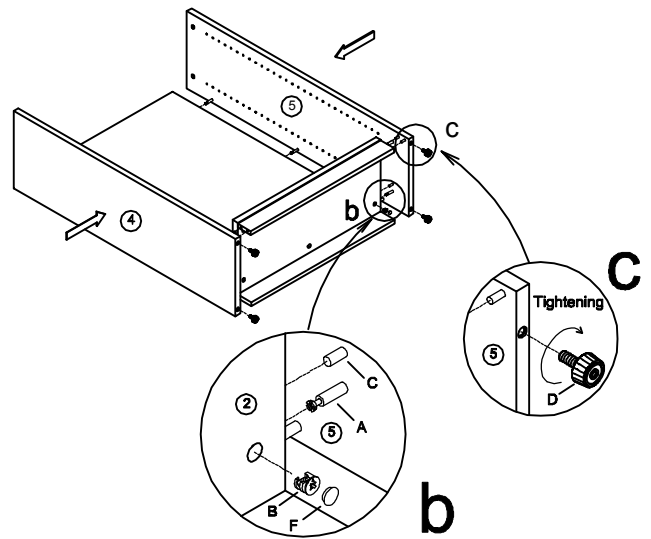

STEP3

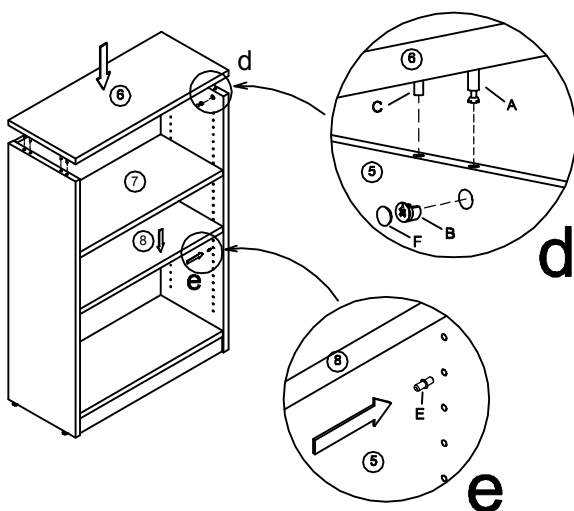

COMPLETED ASSEMBLY

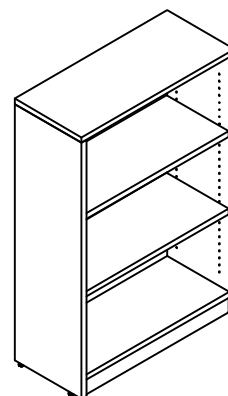

IMPORTANT NOTE:

- It is advisable to assemble unit on a carpet to avoid scratch.
- Check to be sure that you have all parts and hardware.
- Don't tighten all screws/bolts until all completely assembled.
- It is recommended to require 2 persons to complete the assembling.