











Assembly Instructions MODEL NO.: SL6024CS CREDENZA SHELL

CONC10	CONC11	DOWEL	GLIDE	TUN013LB	TUN018SC	TUN015BG	PLASTIC CAP	PLASTIC CAP
A  Cam Lock Pin 12Pcs+2Pcs	B  Cam Lock 12Pcs+2Pcs	C  Dowel 9Pcs+2Pcs	D  Glide 4Pcs	E  L-Bracket 5Pcs	F  Screw #4*5/8" 30Pcs+5Pcs	G  Grommet 2Pcs	H  DEEP CAMLOCK CAP 4Pcs+1Pc	I  CAMLOCK CAP 8Pcs+1Pc

STEP 1

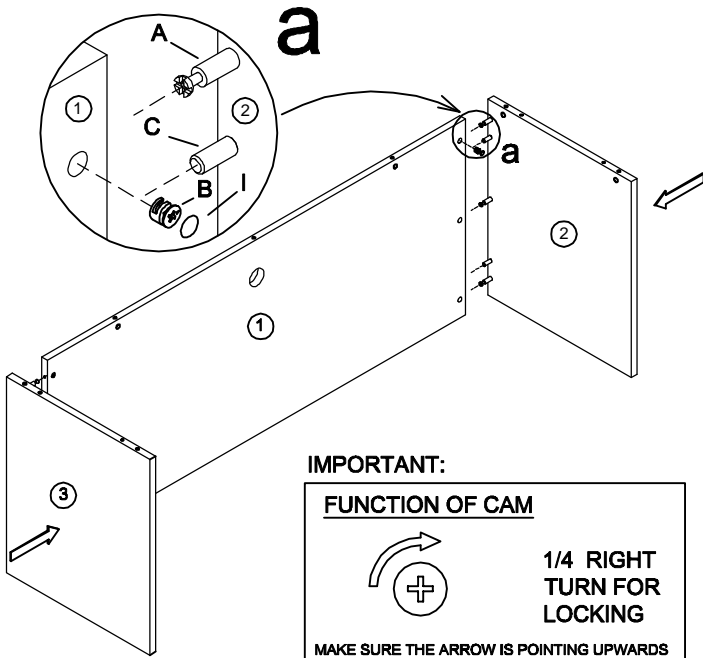

IMPORTANT:
FUNCTION OF CAM



1/4 RIGHT TURN FOR LOCKING

MAKE SURE THE ARROW IS POINTING UPWARDS BEFORE INSERTING INTO THE PANEL'S HOLE.

STEP 2

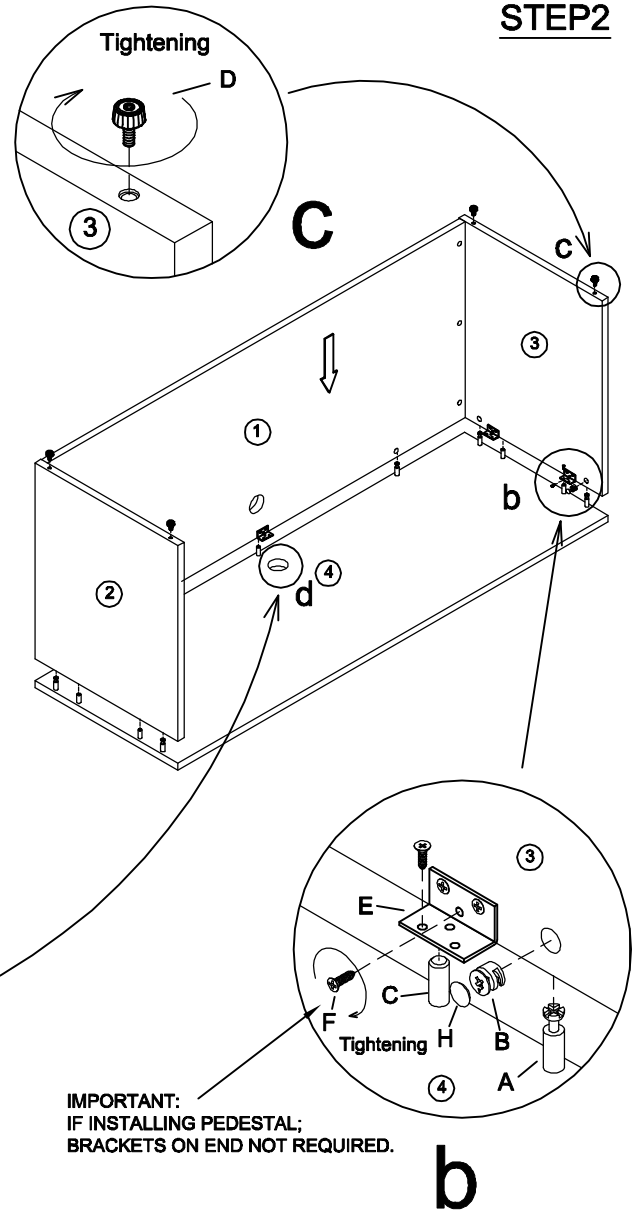

IMPORTANT:
IF INSTALLING PEDESTAL;
BRACKETS ON END NOT REQUIRED.

IMPORTANT NOTE:

- It is advisable to assemble units on a carpet to avoid scratching the piece.
- Check to be sure you have all the parts and hardware.
- Don't tighten all screws/bolts until the item is completely assembled.
- Assembly requires two people.